



POWERED BY GS1 US

OVERVIEW

CLUSTERS, SEGMENTS, AND PIPS

Version 02.16.00

Prepared by: RosettaNet Program Office

Date: 28 February 2014

Table of Contents

1 Document Management.....	1
1.1 Legal Disclaimer	1
1.2 Copyright	1
1.3 Trademarks	1
1.4 Document Version History	1
1.5 Document Purpose.....	2
2 Document Overview	3
2.1 Scope	3
2.1.1 Intended Audience	3
2.1.2 RosettaNet Implementation Guidelines.....	3
2.2 Background	3
2.3 Support.....	3
3 Cluster 0: RosettaNet Support.....	4
3.1 Segment 0A: Administrative.....	4
3.1.1 PIP 0A1: Notification of Failure.....	4
3.2 Segment 0C: Testing.....	5
3.2.1 PIP 0C1: Asynchronous Test Notification.....	5
3.2.2 PIP 0C2: Asynchronous Test Request / Confirmation	6
3.2.3 PIP 0C3: Synchronous Test Notification	7
3.2.4 PIP 0C4: Synchronous Test Query / Response	8
4 Cluster 1: Partner Product and Service Review	9
4.1 Segment 1A: Partner Review	9
4.1.1 PIP 1A1: Request Account Setup	9
4.1.2 PIP 1A2: Maintain Account.....	10
5 Cluster 2: Product Introduction.....	11
5.1 Segment 2A: Preparation for Distribution	11
5.1.1 PIP 2A1: Distribute Product Catalog Information.....	11
5.1.2 PIP 2A3: Query Marketing Information	12
5.1.3 PIP 2A4: Query Sales Promotion & Rebate Information	13
5.1.4 PIP 2A6: Query Product Lifecycle Information.....	14
5.1.5 PIP 2A7: Query Product Discontinuation Information	15
5.1.6 PIP 2A9: Query Technical Product Information.....	16
5.1.7 PIP 2A10: Distribute Design Engineering Information	17
5.1.8 PIP 2A12: Distribute Product Master	18
5.1.9 PIP 2A13: Distribute Material Composition Information	19
5.1.10 PIP 2A15: Request Material Composition Information	20
5.1.11 PIP 2A16: Distribute Engineering Information Inquiry.....	21
5.1.12 PIP 2A17: Notify of Certificate of Analysis.....	22
5.1.13 PIP 2A18: Notify of Certificate of Analysis Response	23
5.2 Segment 2B: Product Change Notification	24
5.2.1 PIP 2B1: Change Basic Product Information	24
5.2.2 PIP 2B2: Change Marketing Information	25

5.2.3	PIP 2B3: Change Sales Promotion & Rebate Information	26
5.2.4	PIP 2B4: Change Product Technical Information.....	27
5.2.5	PIP 2B5: Change Product Lifecycle Information.....	28
5.2.6	PIP 2B7: Notify of Product Change.....	29
5.2.7	PIP 2B8: Notify of Product Change Query.....	30
5.2.8	PIP 2B9: Notify of Product Change Acceptance	31
5.3	Segment 2C: Product Design Information.....	32
5.3.1	PIP 2C1: Distribute Engineering Change Status	32
5.3.2	PIP 2C2: Request Engineering Change.....	33
5.3.3	PIP 2C3: Distribute Engineering Change Response	34
5.3.4	PIP 2C4: Request Engineering Change Approval	35
5.3.5	PIP 2C5: Notify of Engineering Change Order	36
5.3.6	PIP 2C6: Notify of Engineering Change Implementation Plan	37
5.3.7	PIP 2C7: Request Bill of Material	38
5.3.8	PIP 2C8: Notify of Bill of Material.....	39
5.3.9	PIP 2C9: Request Approved Manufacturer List	40
5.3.10	PIP 2C10: Notify of Approved Manufacturer List.....	41

6 Cluster 3: Order Management42

6.1	Segment 3A: Quote and Order Entry	42
6.1.1	PIP 3A1: Request Quote.....	42
6.1.2	PIP 3A2: Request Price and Availability.....	43
6.1.3	PIP 3A3: Request Shopping Cart Transfer	44
6.1.4	PIP 3A4: Request Purchase Order.....	45
6.1.5	PIP 3A5: Query Order Status	46
6.1.6	PIP 3A6: Distribute Order Status	47
6.1.7	PIP 3A7: Notify of Purchase Order Update.....	48
6.1.8	PIP 3A8: Request Purchase Order Change.....	49
6.1.9	PIP 3A9: Request Purchase Order Cancellation	50
6.1.10	PIP 3A10: Notify of Quote Acknowledgement.....	51
6.1.11	PIP 3A13: Notify of Purchase Order Information	52
6.1.12	PIP 3A14: Distribute Planned Order	53
6.1.2	PIP 3A15: Notify of Quote Request	54
6.1.2	PIP 3A16: Notify of Quote Confirmation.....	55
6.1.2	PIP 3A17: Distribute Price And Availability Request	56
6.1.3	PIP 3A18: Distribute Price And Availability Response	57
6.1.4	PIP 3A19: Notify of Purchase Order Request.....	58
6.1.5	PIP 3A20: Notify of Purchase Order Confirmation	59
6.1.6	PIP 3A21: Notify of Purchase Order Change Request	60
6.1.7	PIP 3A22: Notify of Purchase Order Change Confirmation.....	61
6.1.8	PIP 3A23: Notify of Purchase Order Cancellation Request.....	62
6.1.9	PIP 3A24: Notify of Purchase Order Cancellation Confirmation	63
6.2	Segment 3B: Transportation and Distribution.....	64
6.2.1	PIP 3B1: Distribute Transportation Projection	64
6.2.2	PIP 3B2: Notify of Advance Shipment.....	65
6.2.3	PIP 3B3: Distribute Shipment Status	66
6.2.4	PIP 3B4: Query Shipment Status	67
6.2.5	PIP 3B5: Request Shipment Change.....	68
6.2.6	PIP 3B6: Notify of Shipments Tendered	69
6.2.7	PIP 3B11: Notify of Shipping Order	70
6.2.8	PIP 3B12: Request Shipping Order.....	71
6.2.9	PIP 3B13: Notify of Shipping Order Confirmation	72

6.2.10	PIP 3B14: Request Shipping Order Cancellation	73
6.2.11	PIP 3B18: Notify of Shipment Documentation	74
6.2.12	PIP 3B19: Notify of Shipping Order Request	75
6.2.13	PIP 3B20: Notify of Shipping Order Confirmation	76
6.2.14	PIP 3B21: Notify of Shipping Order Cancellation Request	77
6.2.15	PIP 3B22: Notify of Shipping Order Cancellation Confirmation	78
6.3	Segment 3C: Returns and Finance	79
6.3.1	PIP 3C1: Return Product.....	79
6.3.2	PIP 3C2: Request Financing Approval	80
6.3.3	PIP 3C3: Notify of Invoice	81
6.3.4	PIP 3C4: Notify of Invoice Reject	82
6.3.5	PIP 3C5: Notify of Billing Statement.....	83
6.3.6	PIP 3C6: Notify of Remittance Advice	84
6.3.7	PIP 3C7: Notify of Self-Billing Invoice.....	85
6.3.8	PIP 3C8: Notify of Return Product Request.....	86
6.3.9	PIP 3C9: Notify of Return Product Confirmation	87
7	Cluster 4: Inventory Management	88
7.1	Segment 4A: Collaborative Forecasting	88
7.1.1	PIP 4A1: Notify of Strategic Forecast.....	88
7.1.2	PIP 4A2: Notify of Embedded Release Forecast	90
7.1.4	PIP 4A4: Notify of Planning Release Forecast.....	92
7.1.5	PIP 4A5: Notify of Forecast Reply	93
7.1.6	PIP 4A6: Notify of Forecasting Exception	94
7.2	Segment 4B: Inventory Allocation	95
7.2.1	PIP 4B2: Notify of Shipment Receipt	95
7.2.2	PIP 4B3: Notify of Consumption	96
7.3	Segment 4C: Inventory Reporting	97
7.3.1	PIP 4C1: Distribute Inventory Report	97
7.4	Segment 4D: Inventory Replenishment.....	98
7.4.1	PIP 4D1: Notify of Material Release.....	98
7.5	Segment 4E: Sales Reporting	99
7.5.1	PIP 4E1: Notify of Sales Report	99
7.5.2	PIP 4E2: Notify of Sales Report Acknowledgement	100
8	Cluster 5: Marketing Information Management	101
8.1	Segment 5C: Design Win Management (Electronic Components)	101
8.1.1	PIP 5C1: Distribute Product List.....	101
8.1.2	PIP 5C2: Request Design Registration	102
8.1.3	PIP 5C3: Create Design Win.....	103
8.1.4	PIP 5C4: Distribute Registration Status	104
8.1.5	PIP 5C5: Query Registration Status.....	105
8.1.6	PIP 5C6: Notify of Design Registration Request.....	106
8.1.7	PIP 5C7: Notify of Design Registration Confirmation	107
8.1.8	PIP 5C8: Notify of Win Claim Request.....	108
8.1.8	PIP 5C9: Notify of Win Claim Confirmation	109
8.2	Segment 5D: Ship from Stock and Debit (Electronic Components)	110
8.2.1	PIP 5D1: Request Ship from Stock and Debit Authorization	110
8.2.2	PIP 5D2: Notify of Blanket Ship from Stock and Debit Authorization	111
8.2.3	PIP 5D3: Distribute Open Ship from Stock and Debit Authorization Status	112
8.2.4	PIP 5D4: Query Ship from Stock and Debit Authorization Status	113

8.2.5	PIP 5D5: Create Ship from Stock and Debit Claim Status	114
8.2.6	PIP 5D6: Notify of Ship from Stock and Debit Claim Status.....	115
8.2.7	PIP 5D7: Notify of Ship From Stock And Debit Authorization Request.....	116
8.2.8	PIP 5D8: Notify of Ship From Stock And Debit Authorization Confirmation	117
8.2.9	PIP 5D9: Notify of Ship From Stock And Debit Claim Request	118
8.2.10	PIP 5D10: Notify of Ship From Stock And Debit Claim Confirmation	119
9	Cluster 6: Service and Support	120
9.1	Segments 6A: Provide and Administer Warranties, Service Packages, and Contract Services	120
9.1.1	PIP 6A1 – Notify of Service Contract Request	120
9.1.2	PIP 6A2 – Notify of Service Contract Reply	121
9.2	Segment 6C: Technical Support & Service Management	122
9.2.1	PIP 6C1: Query Service Entitlement	122
9.2.2	PIP 6C2: Request Warranty Claim.....	123
9.2.3	PIP 6C3: Notify of Case Request.....	124
9.2.4	PIP 6C4: Notify of Case Confirmation	125
9.1.1	PIP 6C5: Distribute Service Entitlement Query.....	126
9.2.5	PIP 6C6: Distribute Service Entitlement Status Response	127
9.2.6	PIP 6C7: Notify of Warranty Claim Request	128
9.2.7	PIP 6C8: Notify of Warranty Claim Confirmation	129
10	Cluster 7: Manufacturing	130
10.1	Segment 7B: Manage Manufacturing WO and WIP	130
10.1.1	PIP 7B1: Distribute Work in Process.....	130
10.1.2	PIP 7B2: Query Work in Process	131
10.1.3	PIP 7B5: Notify Of Manufacturing Work Order.....	132
10.1.4	PIP 7B6: Notify of Manufacturing Work Order Reply	133
10.2	Segment 7C: Distribute Manufacturing Information	134
10.2.1	PIP 7C6: Distribute Product Quality Event Data	134
10.2.2	PIP 7C7: Notify of Semiconductor Test Data.....	135
10.2.3	PIP 7C8: Notify of Semiconductor Process Data	136
10	Appendix: PIP Summary	137

1 Document Management

1.1 Legal Disclaimer

RosettaNet, its members, officers, directors, employees, or agents shall not be liable for any injury, loss, damages, financial or otherwise, arising from, related to, or caused by the use of this document or the specifications herein, as well as associated guidelines and schemas. The use of said specifications shall constitute your express consent to the foregoing exculpation.

1.2 Copyright

©2013 RosettaNet. All rights reserved. No part of this publication may be reproduced, stored in a retrieval system, or transmitted, in any form or by any means, electronic, mechanical, photocopying, recording, or otherwise, without the inclusion of this copyright notice. Any derivative works must cite the copyright notice. Any public redistribution or sale of this publication or derivative works requires prior written permission of the publisher.

1.3 Trademarks

RosettaNet, Partner Interface Process, PIP and the RosettaNet logo are trademarks or registered trademarks of "RosettaNet," a non-profit organization. All other product names and company logos mentioned herein are the trademarks of their respective owners. In the best effort, all terms mentioned in this document that are known to be trademarks or registered trademarks have been appropriately recognized in the first occurrence of the term.

1.4 Document Version History

This section records the change history of this document.

Version	Date	Description
01.00.00A	10 May 2000	RosettaNet: Authorized for Distribution
01.00.00B	30 August 2000	RosettaNet: Authorized for Distribution
01.01.00	12 September 2000	RosettaNet: Authorized for Distribution
02.00.00	15 November 2006	RosettaNet: Updated content for market release.
02.01.00	05 May 2007	RosettaNet: To include additional/ new PIPs, update content, and format modifications.
02.02.00	20 July 2007	RosettaNet: To reflect the availability of newly released XML schema PIPs (S2M effort).
02.02.01	22 August 2007	RosettaNet: To include RIG information.
02.03.00	10 December 2007	RosettaNet: To reflect newly released XML schema PIPs (mainly from S2M Phase 2).
02.04.00	23 April 2008	RosettaNet: To reflect published validation status XML schema PIPs.

Version	Date	Description
02.05.00	10 October 2008	RosettaNet: To reflect newly published PIP(s) (including S2M to Validated PIP(s) as announced early of 2008) and for this version, section 2.3 is added.
02.06.00	09 January 2009	RosettaNet: To reflect new PIP(s) published.
02.07.00	09 April 2009	RosettaNet: To reflect new PIP(s) published and format update.
02.08.00	21 August 2009	RosettaNet: To reflect new PIP(s) published.
02.09.00	20 November 2009	RosettaNet: To reflect new PIP(s) published.
02.10.00	20 April 2010	RosettaNet: To reflect new PIP(s) published.
02.11.00	02 August 2010	RosettaNet: To reflect new PIP(s) published.
02.12.00	14 December 2010	RosettaNet: To reflect new PIP(s) published.
02.13.00	5 December 2011	RosettaNet: To reflect new PIP(s) published.
02.14.00	6 February 2013	RosettaNet: To reflect new PIP(s) published.
02.15.00	13 September 2013	RosettaNet: To reflect new PIP(s) published.
02.16.00	28 February 2014	RosettaNet: To reflect new PIP(s) published.

1.5 Document Purpose

This document summarizes the intended purpose for each Partner Interface Process (PIP) (not including retired and obsolete standards).

2 Document Overview

2.1 Scope

This document contains published PIPs only. It does not contain the status of each PIP and some PIP names are subject to change.

2.1.1 Intended Audience

This document is for the use of members and non-members who require an overview of the business processes available.

2.1.2 RosettaNet Implementation Guidelines

RosettaNet provides user authored Implementation Guide documentation for PIPs and technical specification documents that have been validated. These guides provide details of the validation team's implementation experience for a given standard. A RIG is comprised of two documents that illustrate the scope of the validation team's deployment, change history of the specific standard and a mapping guide. The purpose of the RIG is to reduce implementation time and accelerate adoption.

2.2 Background

RosettaNet aims to align the business processes of supply chain partners. This goal is achieved by the creation of RosettaNet Partner Interface Processes or PIPs and it helps to define business processes between trading partners. Each PIP defines how two specific processes, running in two different partners' organizations, will be standardized and interfaced across the entire supply chain. PIP includes all business logic, message flow, and message contents to enable alignment of the two processes.

RosettaNet has delineated the scope of supply chain processes for which it will design PIPs. This scope is divided into several clusters, segments, or groups of core business processes and within each segment are individual PIPs. The clusters and segments serve as a mechanism to group all supply chain processes into a manageable framework. When partners are ready to implement PIPs, they should not be bound by the rigidity of this framework; they should select from all segments the subset of PIPs required to address specific business interface scenarios.

This document provides an overview of the segments currently outlined.

2.3 Support

If you have questions, please contact us at support@rosettanet.org

3 Cluster 0: RosettaNet Support

This cluster provides administrative and testing functionality.

3.1 Segment 0A: Administrative

This segment provides administrative functionality.

3.1.1 PIP 0A1: Notification of Failure

DTD XML Schema

Purpose: This PIP provides a mechanism for notification of business activity failures amongst participating partner roles. The RNIF 2.0 Core Specification provides a complete list of scenarios in which a General Exception signal MUST be sent and a complete list of scenarios under which the Notification of Failure PIP MUST be initiated. This document describes the Notification of Failure PIP to be used in conjunction with the RNIF 2.0 protocol. Please refer to the RNIF 2.0 Core Specification for a complete list of trigger points for this PIP. Note that it is beyond the scope of RosettaNet to provide the business implications of the PIP. For instance, whether the initiation of this PIP implies a mere notification or that the transaction is to be considered null and void, is left up to the Trading Partners. However, for the sake of completeness of the protocol, this PIP MUST be initiated under all conditions mentioned by the RNIF 2.0 Core Specification.

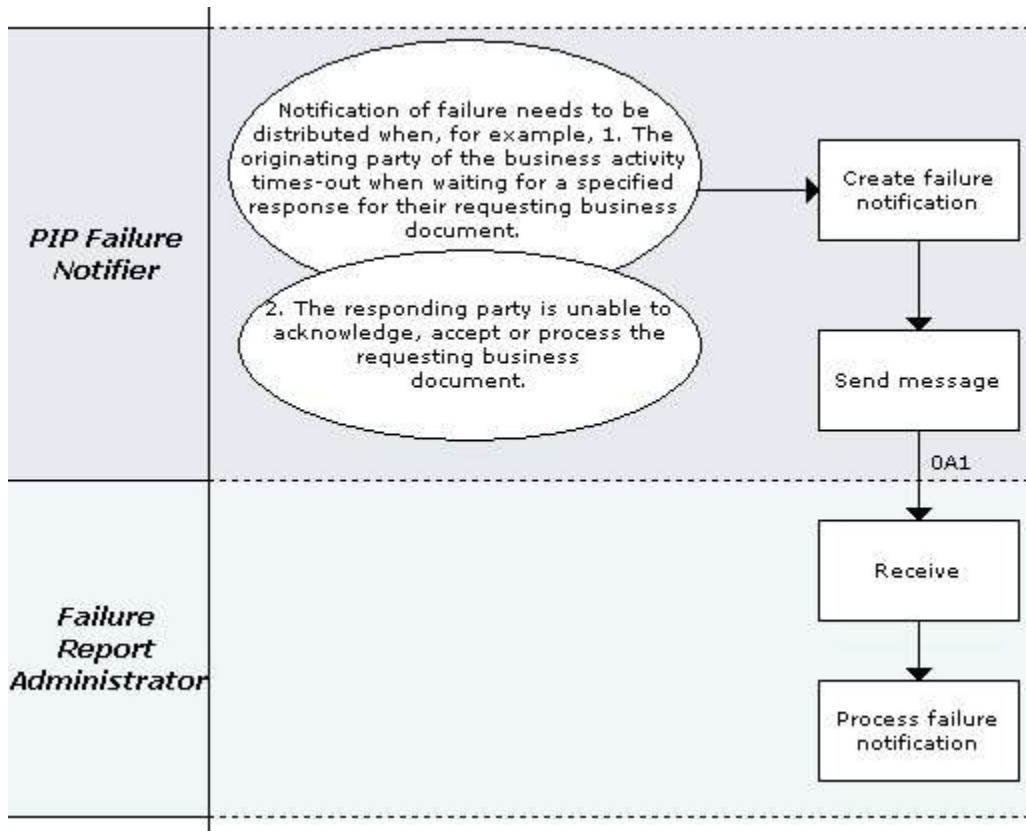

3.2 Segment 0C: Testing

This segment provides testing functionality.

3.2.1 PIP 0C1: Asynchronous Test Notification

DTD XML Schema

Purpose: This PIP enables the testing of transport, packaging and routing functionality for "Asynchronous Notification" process choreography.

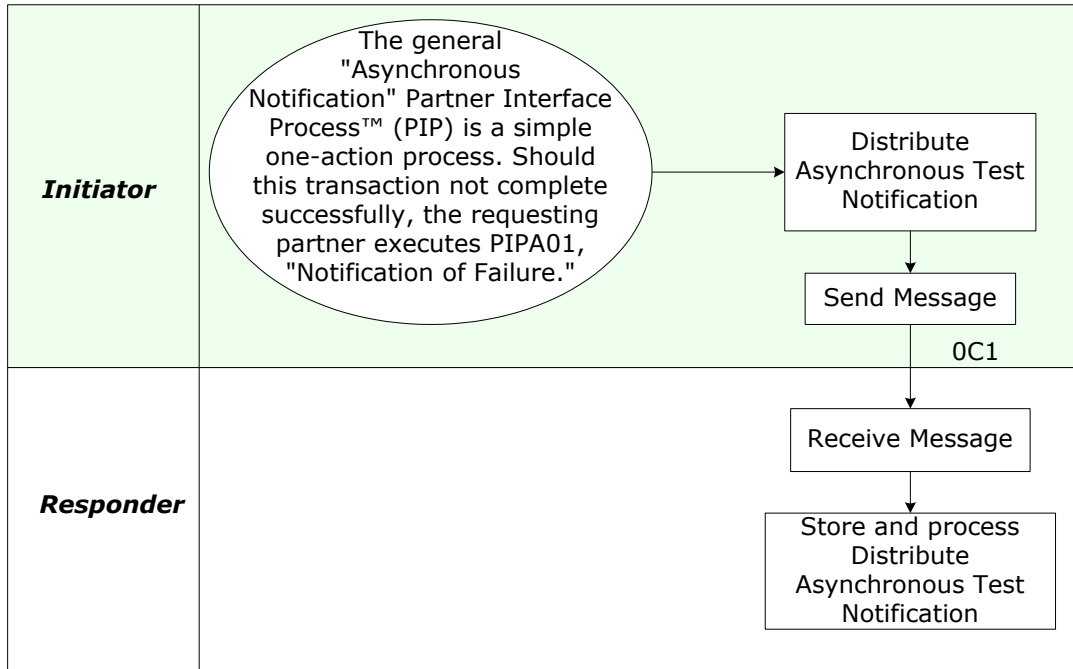

3.2.2 PIP 0C2: Asynchronous Test Request / Confirmation

DTD XML Schema

Purpose: This PIP enables the testing of transport, packaging and routing functionality for asynchronous request confirmation business transaction (PIP) pattern type of process choreography.

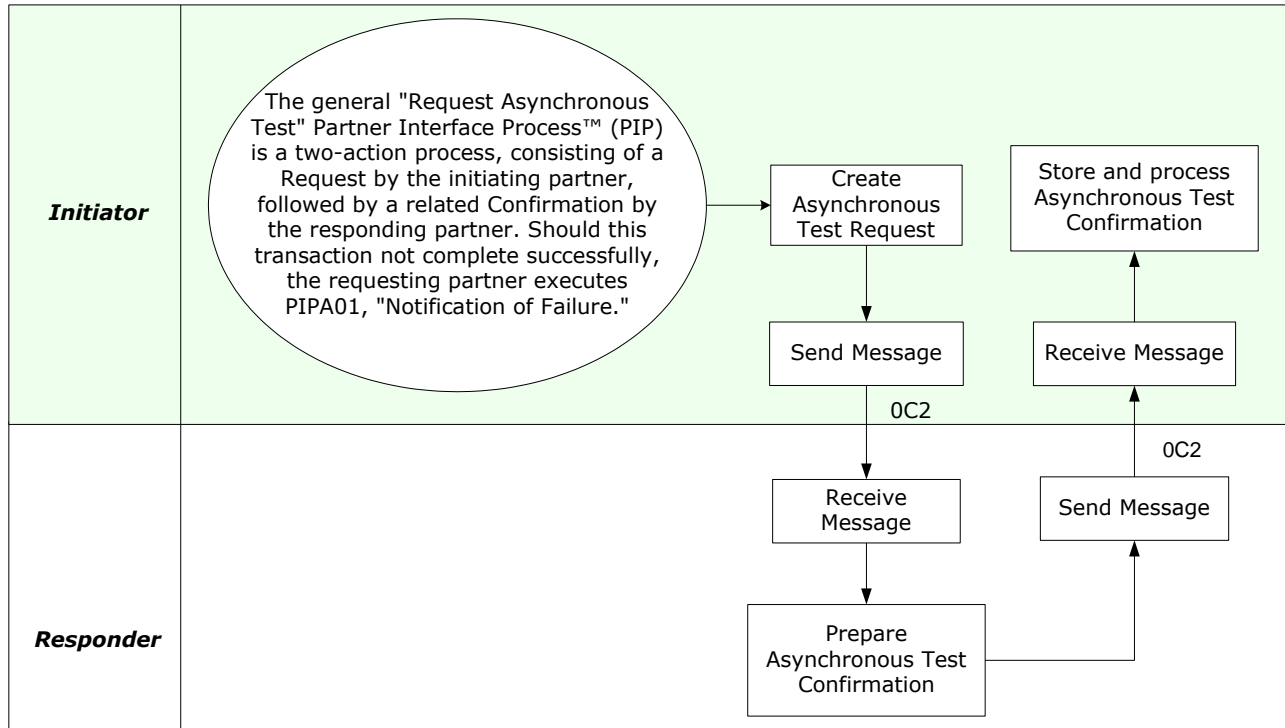

3.2.3 PIP 0C3: Synchronous Test Notification

DTD XML Schema

Purpose: This PIP enables the testing of transport, packaging and routing functionality for "Synchronous Notification" process choreography.

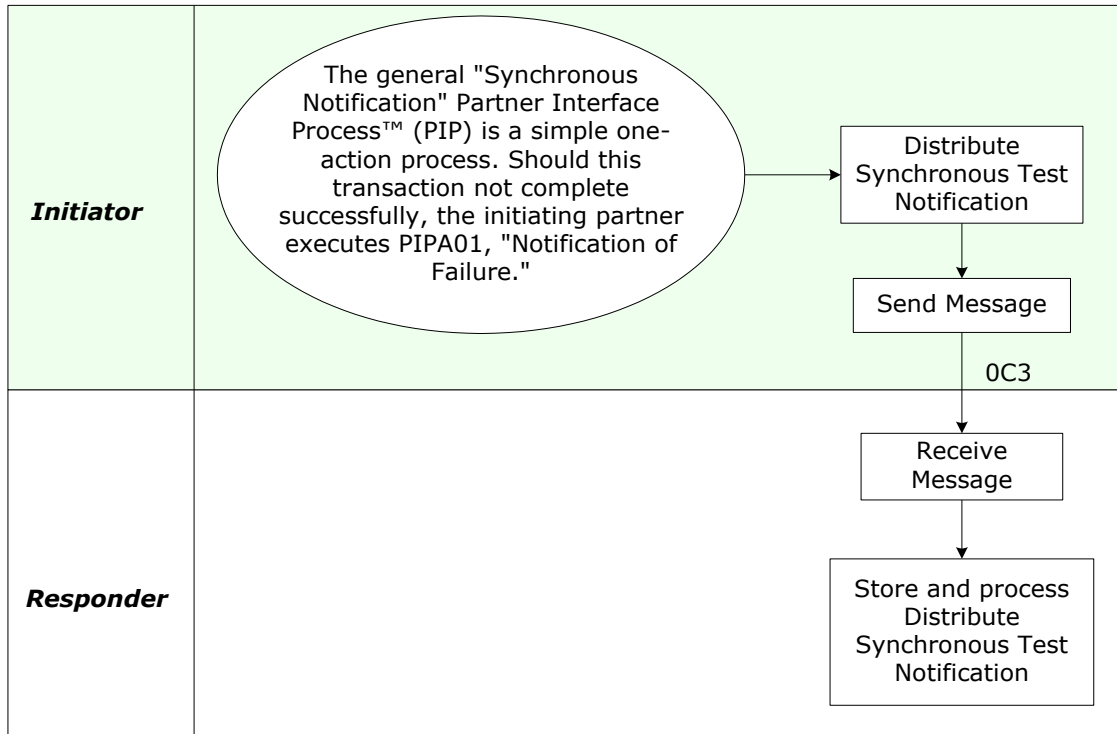

3.2.4 PIP 0C4: Synchronous Test Query / Response

DTD XML Schema

Purpose: This PIP enables the testing of transport, packaging and routing functionality for "Synchronous Query-Response" process choreography.

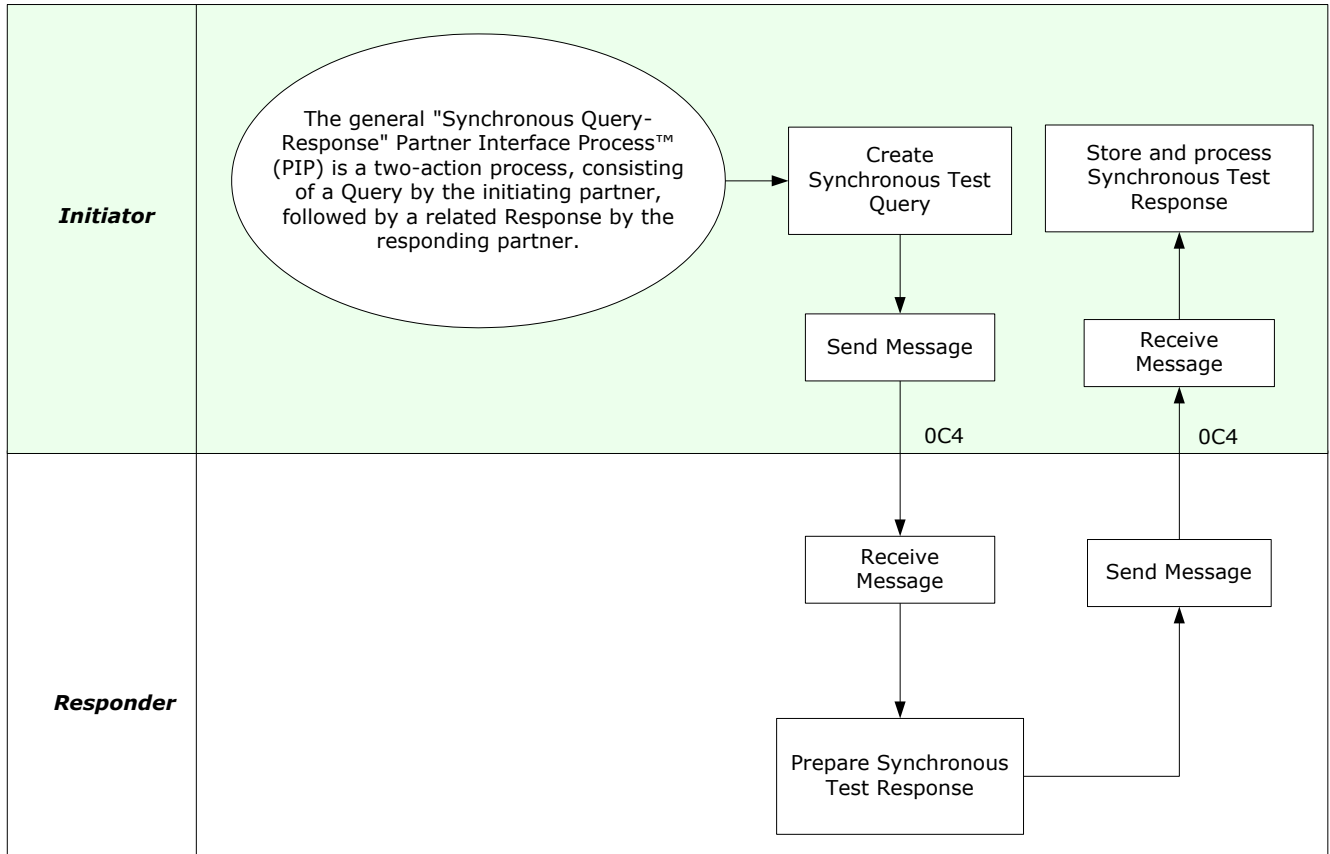

4 Cluster 1: Partner Product and Service Review

This cluster allows information collection, maintenance and distribution for the development of trading-partner profiles and product-information subscriptions.

4.1 Segment 1A: Partner Review

This segment provides the ability to share information, such as locations and contacts, and send and receive acknowledgement of receipt.

4.1.1 PIP 1A1: Request Account Setup

DTD XML Schema

Purpose: This PIP is designed to provide automation support to the process of setting up an account between two partners. It supports two general scenarios which include Customer Account Setup and Vendor Account Setup. Additionally, this PIP® provides the Account Supplier the ability to reject an account setup request. Such a rejection may occur when the Account Requester provides insufficient information or an account already exists. In any event, account setup is at the discretion of the Account Supplier.

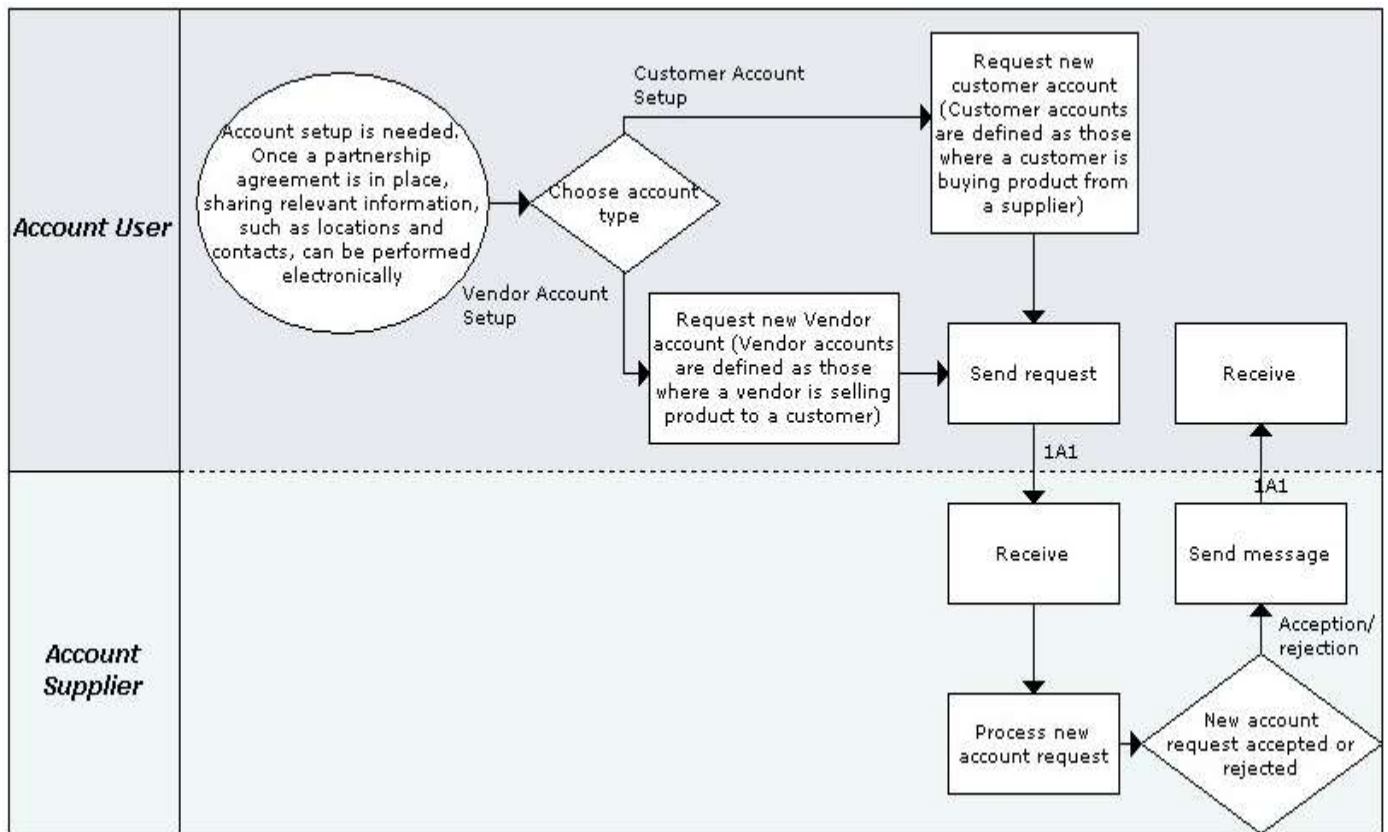

4.1.2 PIP 1A2: Maintain Account

DTD XML Schema

Purpose: This PIP provides a mechanism for notification of business activity failures amongst participating partner roles. The RNIF 2.0 Core Specification provides a complete list of scenarios in which a General Exception signal MUST be sent and a complete list of scenarios under which the Notification of Failure PIP MUST be initiated. This document describes the Notification of Failure PIP to be used in conjunction with the RNIF 2.0 protocol.

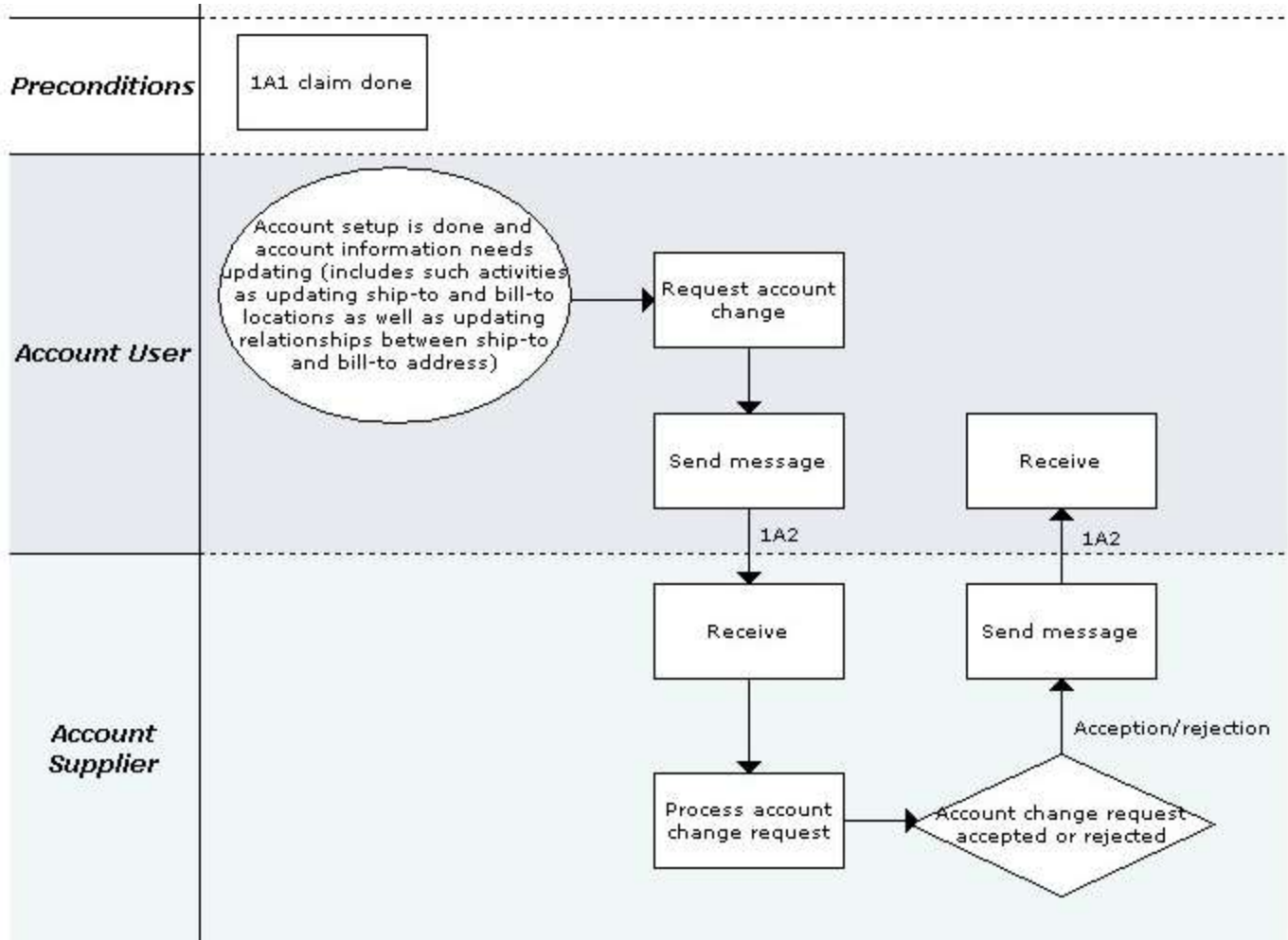

5 Cluster 2: Product Introduction

This cluster enables distribution and periodic update of product and detailed design information, including product change notices and product technical specifications.

5.1 Segment 2A: Preparation for Distribution

This segment enables distribution of product resources, including sales catalog and basic technical information, and obtainment of extended product information.

5.1.1 PIP 2A1: Distribute Product Catalog Information

DTD XML Schema

Purpose: To specify the process for distributing new product information to Buyers so that enterprise systems can be established to accept product orders, and for product information users to populate the Buyer's online sales catalogs.

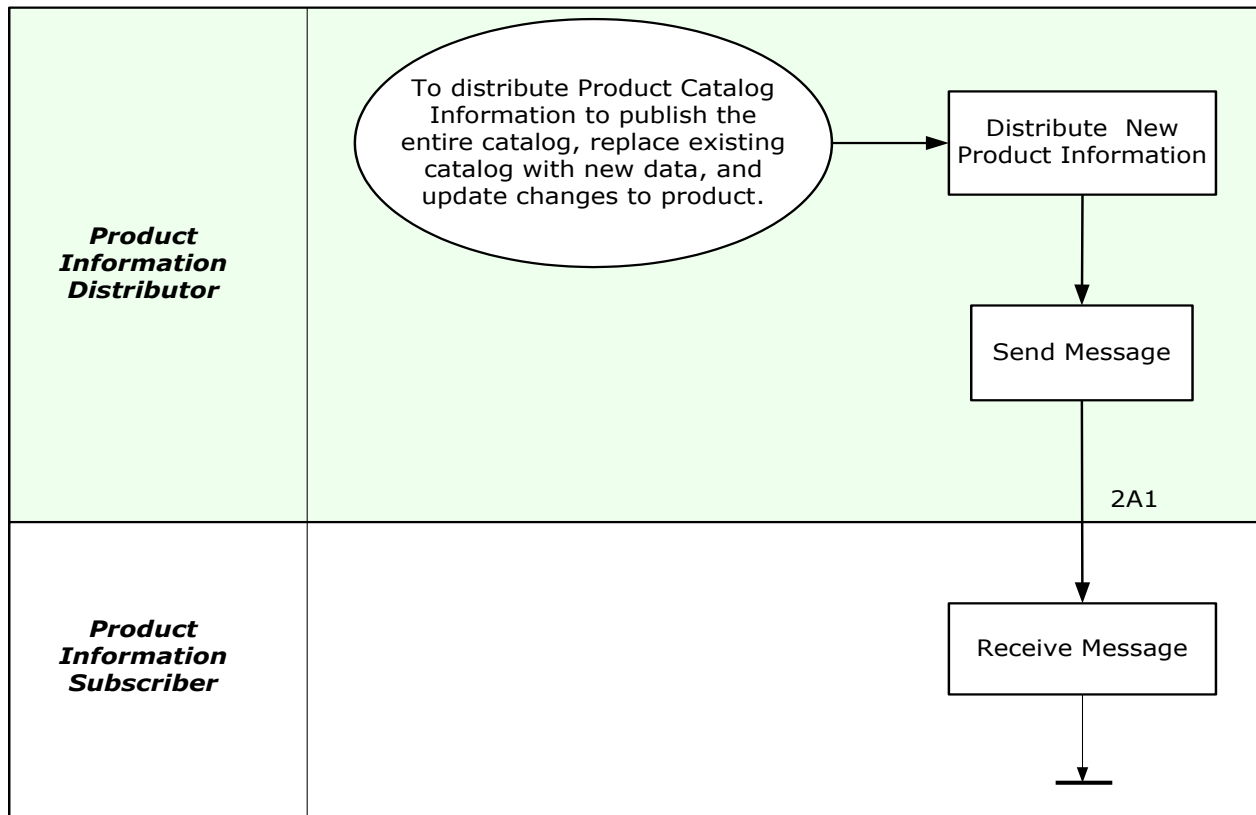

Note: RosettaNet Implementation Guides is available for PIP 2A1 version V02.00.00 (DTD).

5.1.2 PIP 2A3: Query Marketing Information

DTD XML Schema

Purpose: To provide business partners with a systematic approach for querying and receiving marketing information.

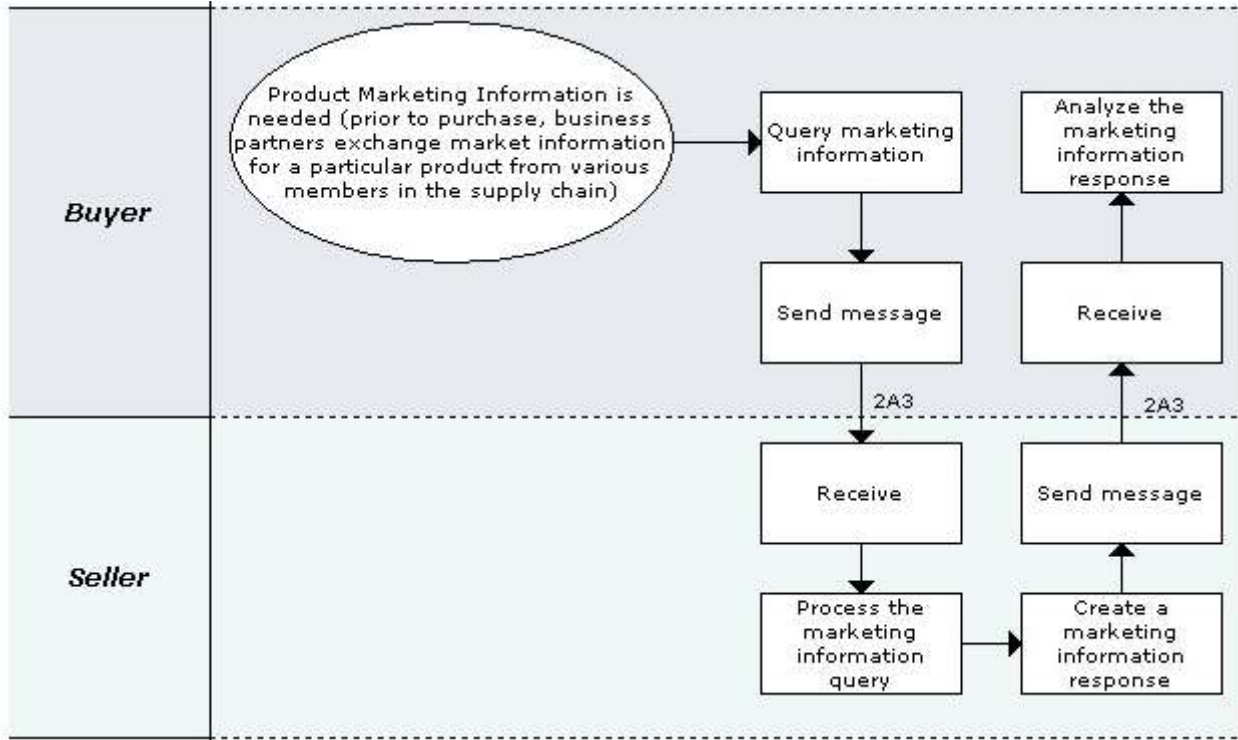

5.1.3 PIP 2A4: Query Sales Promotion & Rebate Information

DTD XML Schema

Purpose: To provide business partners with a systematic approach for requesting and receiving product Sales Promotion and Rebate Information.

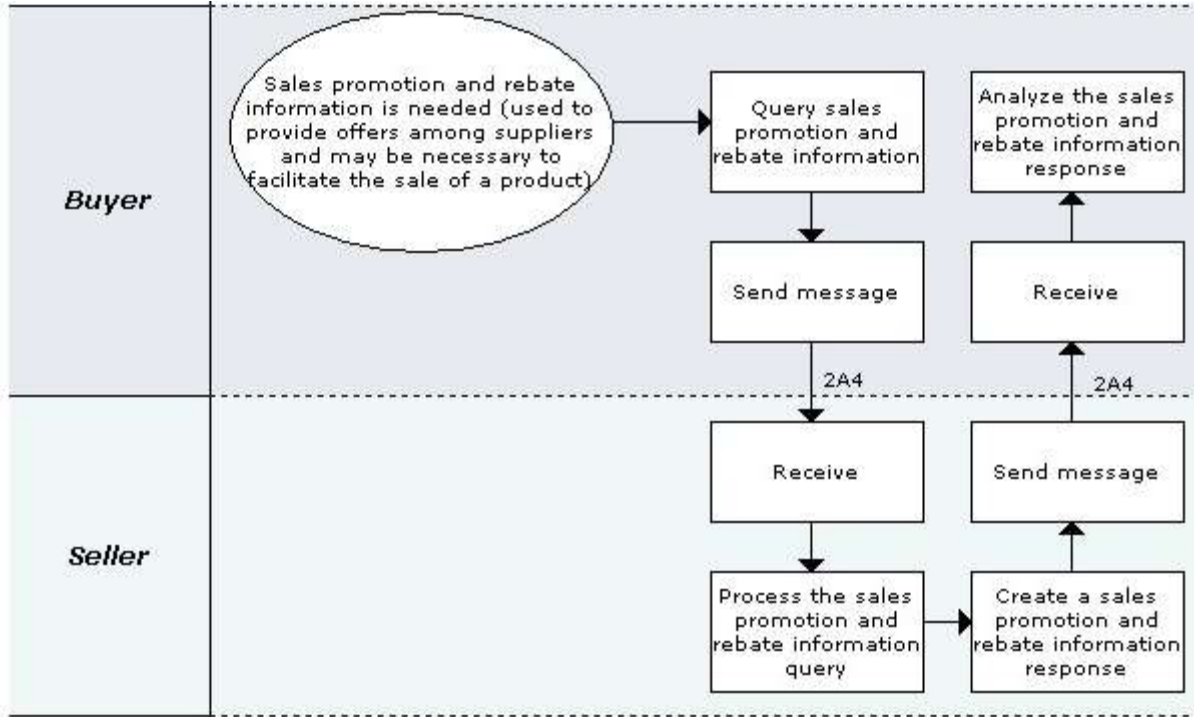

5.1.4 PIP 2A6: Query Product Lifecycle Information

DTD XML Schema

Purpose: To provide business partners with a systematic approach for requesting and receiving Product Lifecycle Information.

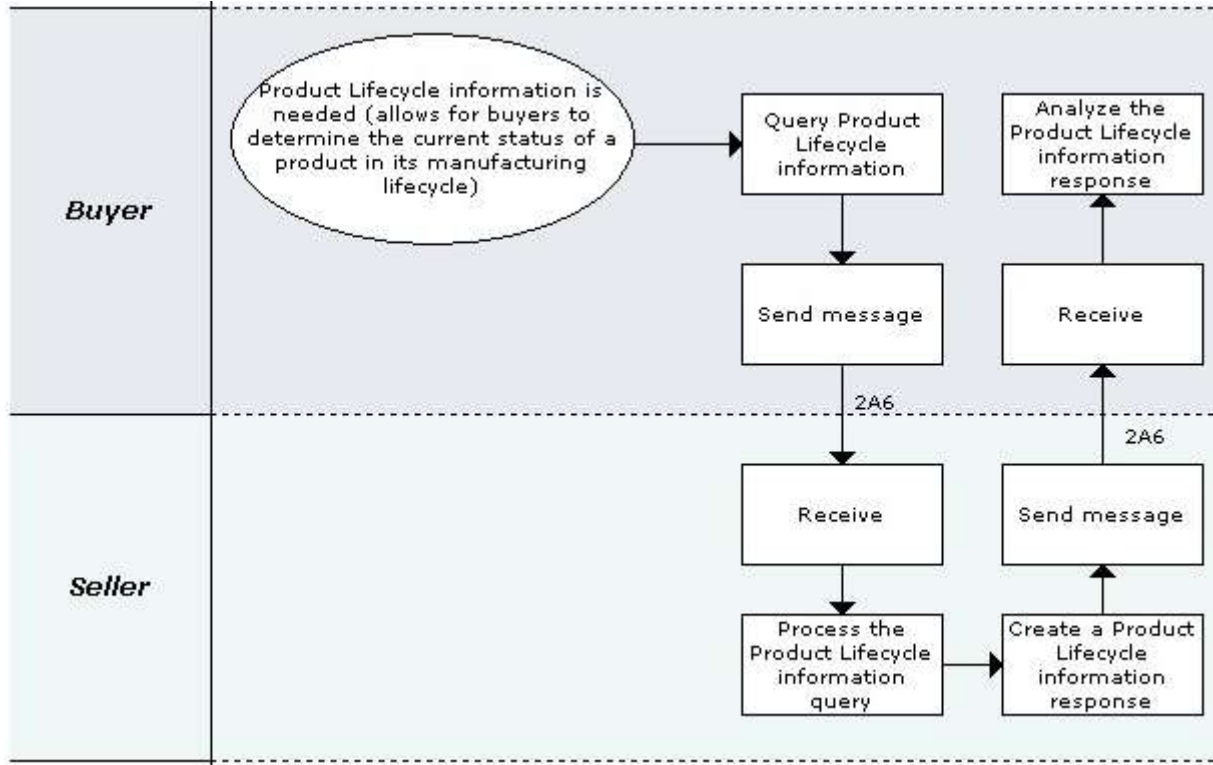

5.1.5 PIP 2A7: Query Product Discontinuation Information

DTD XML Schema

Purpose: To provide business partners with a systematic approach for requesting and receiving Product Discontinuation Information.

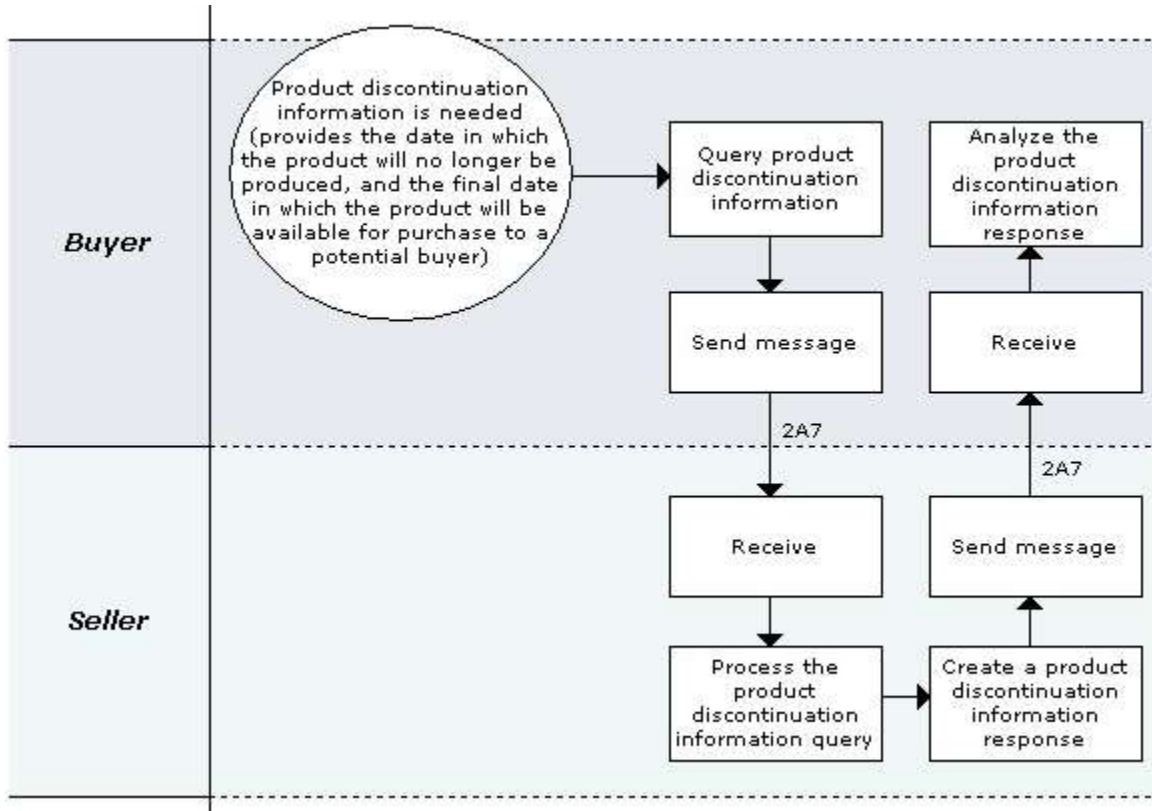

5.1.6 PIP 2A9: Query Technical Product Information

DTD XML Schema

Purpose: To specify the process of querying Electronic Components supply chain partners for technical information. This technical information does not contain sales and order properties such as those found in the sales catalog and fulfillment systems. Partners responding to these queries return component technical specifications that can be used for business activities such as hosting online electronic catalogs and sales configuration systems. Technical product information is that category of information that describes the behavioral, electrical, physical, and other characteristics of products.

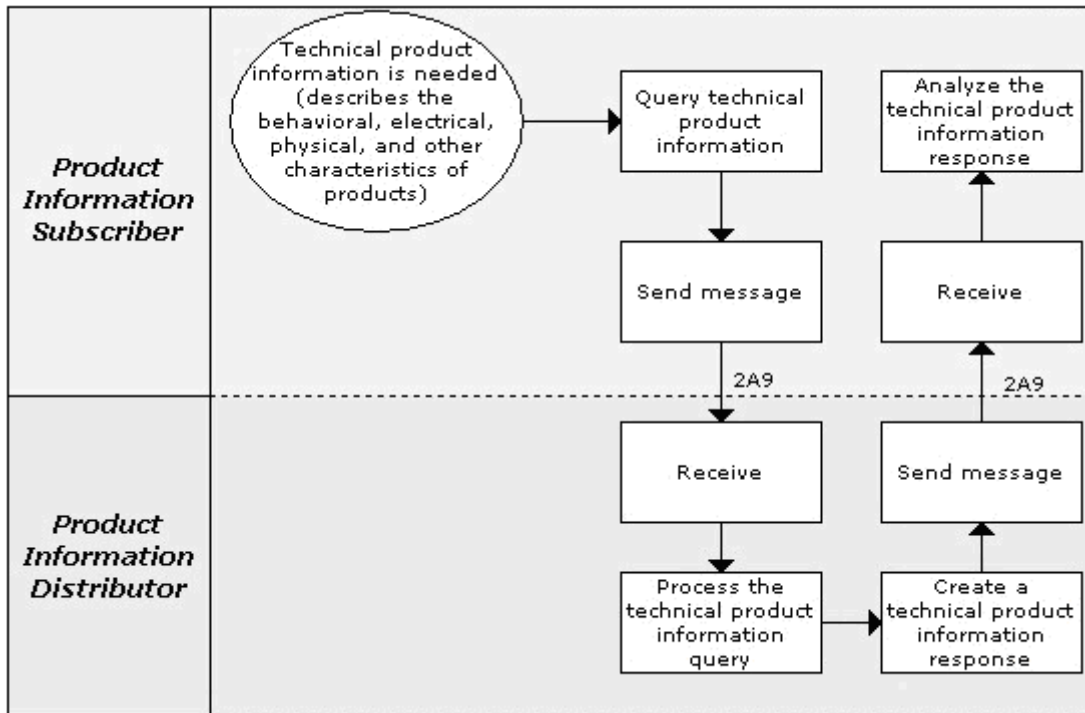

5.1.7 PIP 2A10: Distribute Design Engineering Information

DTD XML Schema

Purpose: To enable a standardized provision of information needed by product designers and product engineers during the planning, design, and engineering processes. This information may be provided directly from the product supplier to the product user, or it may be passed via one or more companies in the distribution chain. Thus, this PIP also supports the provision of technical information to product databases throughout the distribution chain. Design engineering information is either information that describes the behavioural, electrical, physical, and other characteristics of products or business information related to those products that influences design decisions.

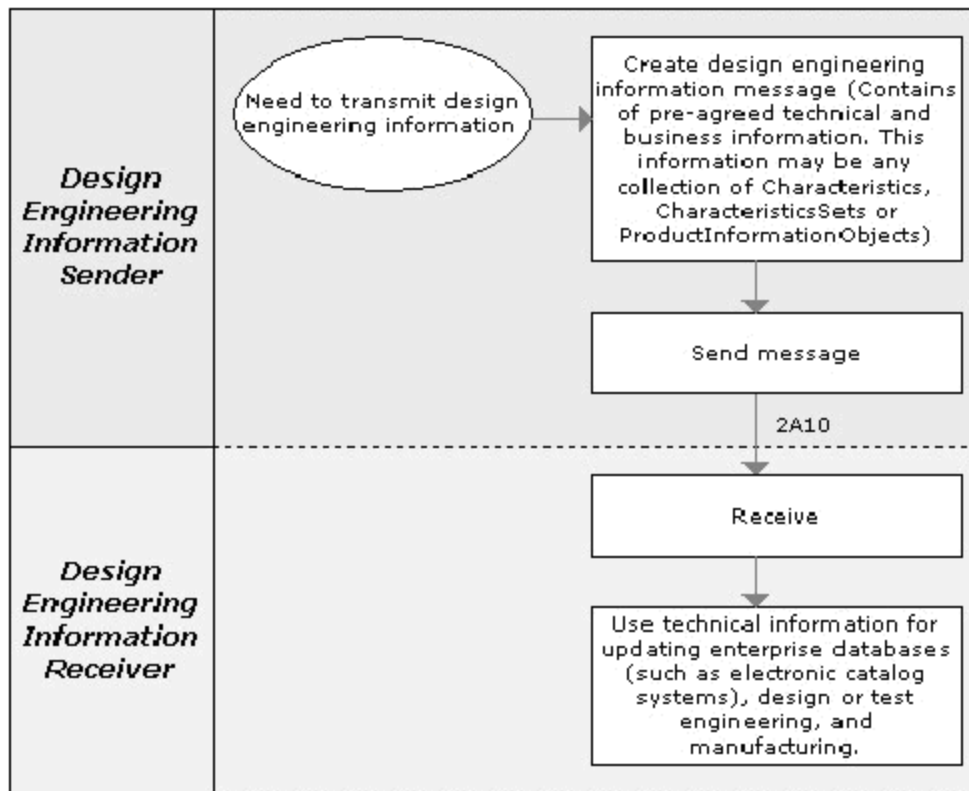

Note: RosettaNet Implementation Guides is available for PIP 2A10 version V01.00.00 (DTD) and version V02.00.00 (DTD).

5.1.8 PIP 2A12: Distribute Product Master

☒ DTD ☒ XML Schema

Purpose: To specify the process for a Product Information Distributor, who is typically a product supplier, to distribute device-level product identification, including family attributes, location specific data, procurement data and limited product lifecycle information, required for the MRP system of a Product Information User, who is typically a product buyer.

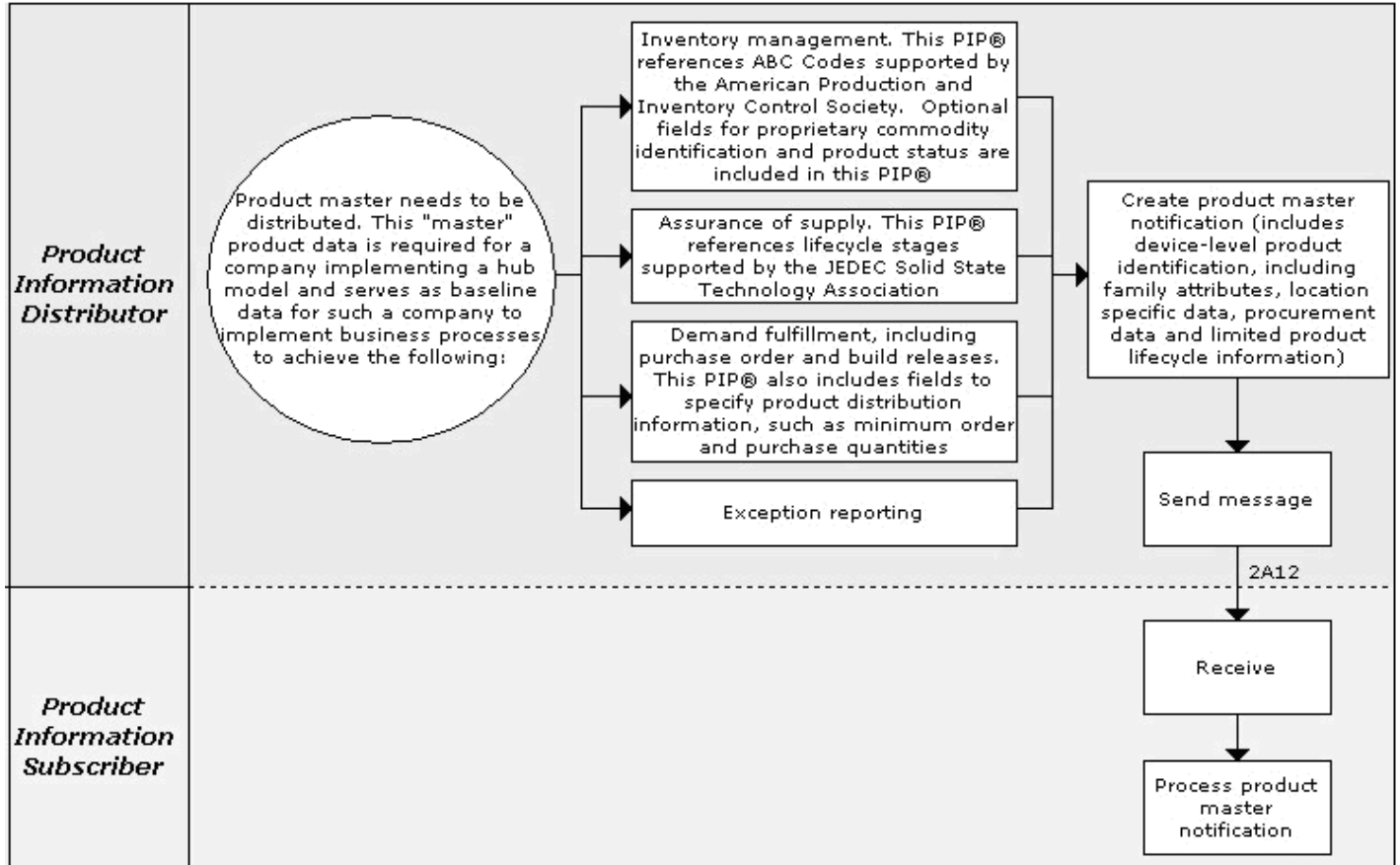

5.1.9 PIP 2A13: Distribute Material Composition Information

DTD XML Schema

Purpose: To supply requested material composition information for a given product(s). This PIP supports the high-tech industry’s needs to know the material composition of their products to satisfy legislation, drive environmental improvements in design, and be capable of providing information for customers and stakeholders when required.

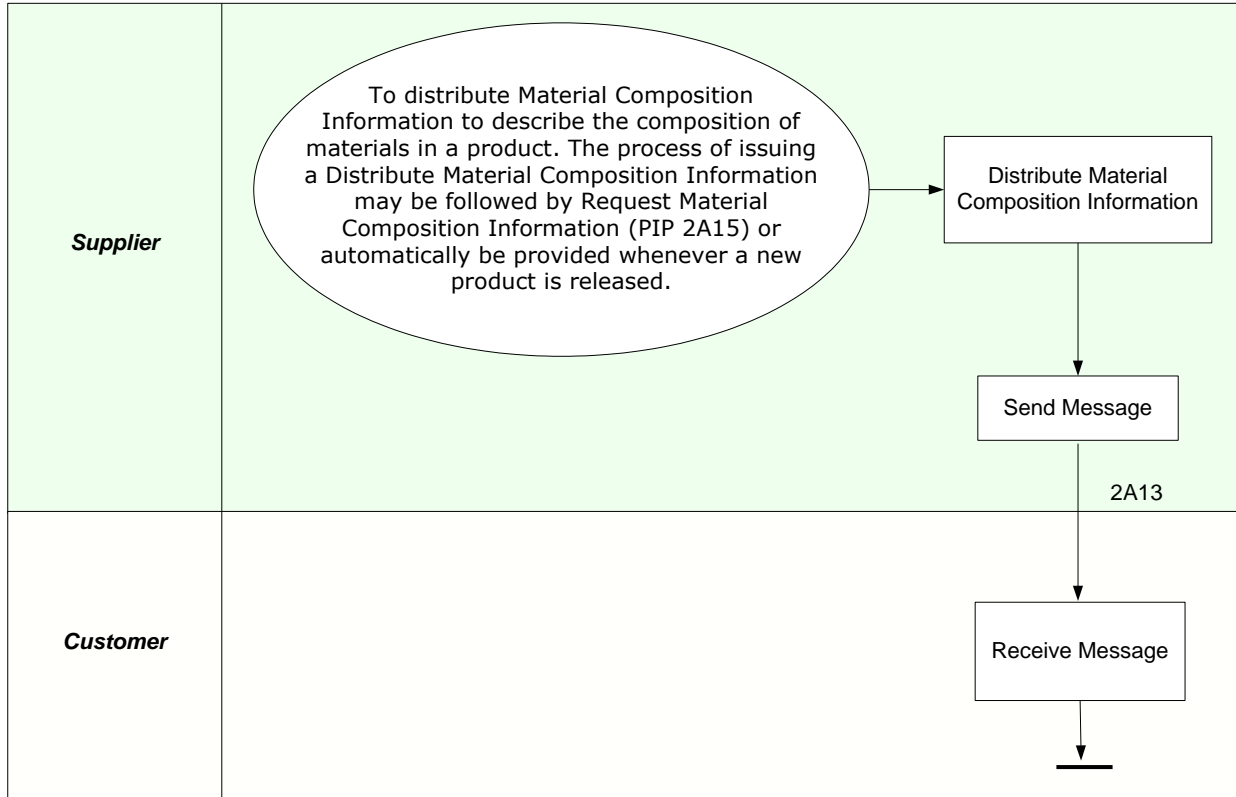

Note: RosettaNet Implementation Guides is available for PIP 2A13 version V11.00.00 (XML Schema)

5.1.10 PIP 2A15: Request Material Composition Information

DTD XML Schema

Purpose: To request product information that describes the composition of materials for a product(s).

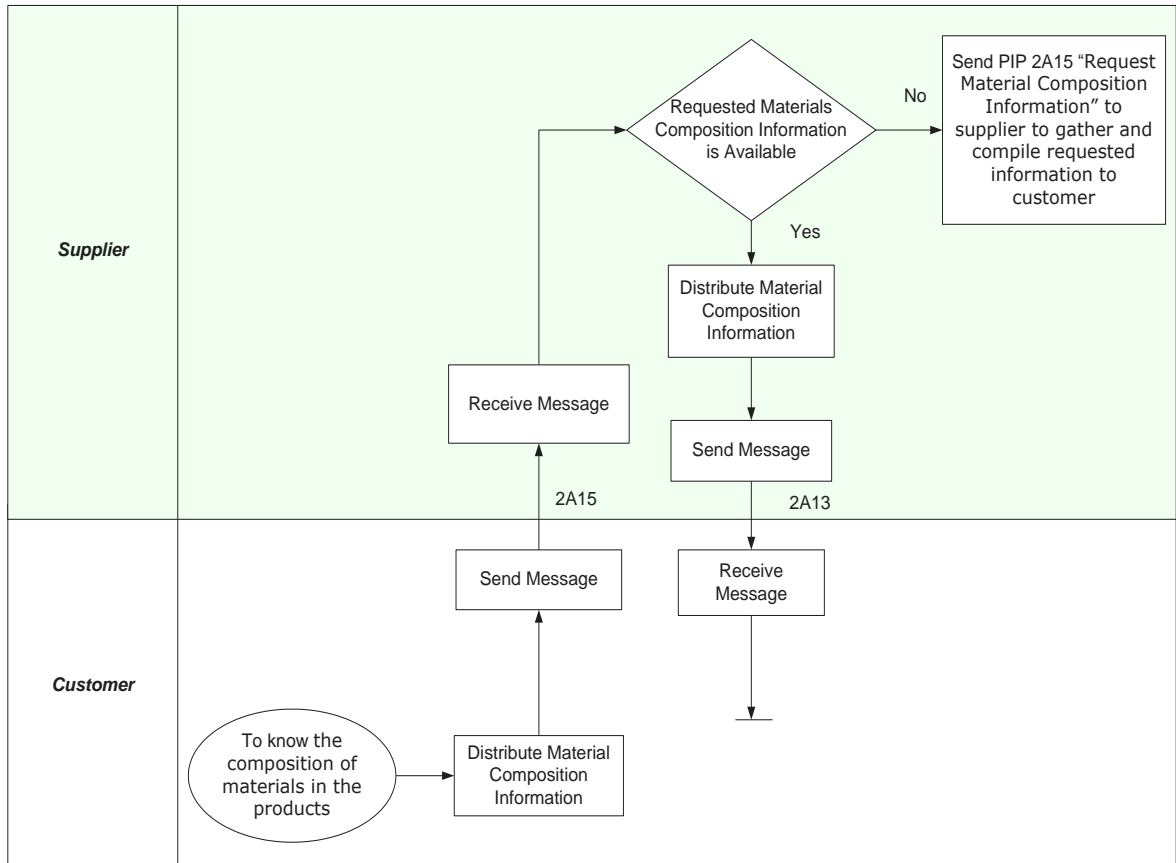

5.1.11 PIP 2A16: Distribute Engineering Information Inquiry

DTD XML Schema

Purpose: The purpose of this PIP is to automate the product engineering information exchanges between supply chain partners.

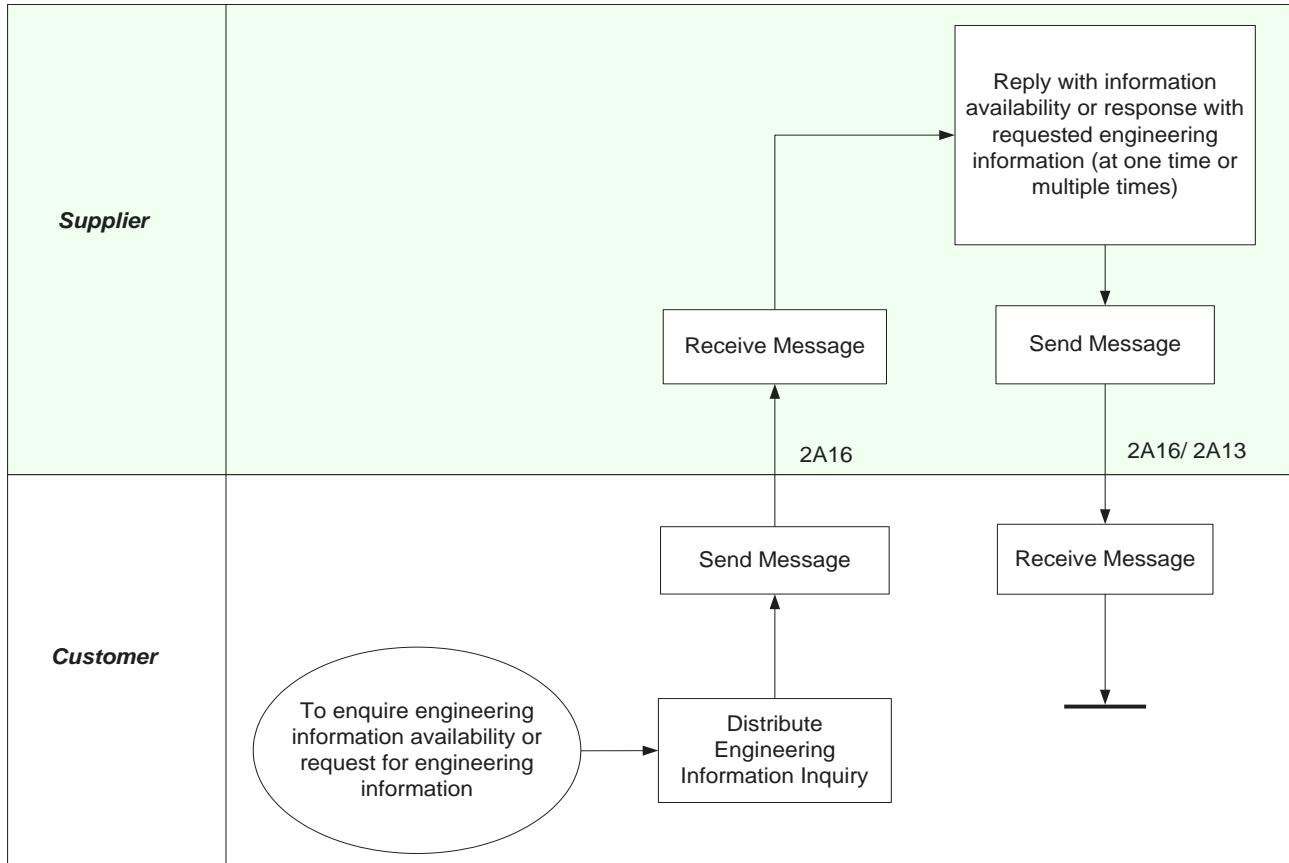

Note: RosettaNet Implementation Guides is available for PIP 2A16 version V11.00.00 (XML Schema).

5.1.12 PIP 2A17: Notify of Certificate of Analysis

DTD XML Schema

Purpose: The purpose of this PIP is to enable the transmission of an accepted standard for certificate of analysis of which the quality or purity of material being shipped is attested.

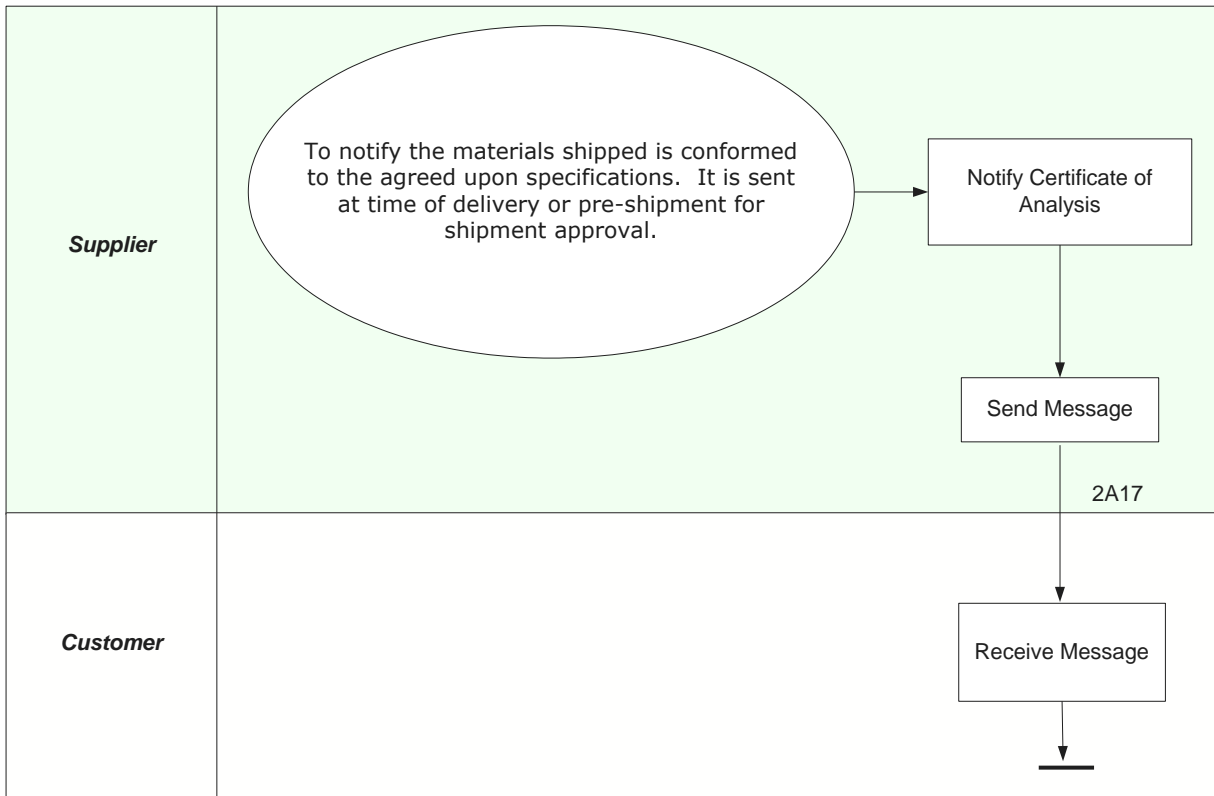

Note: RosettaNet Implementation Guides is available for PIP 2A17 version V11.00.00 (XML Schema).

5.1.13 PIP 2A18: Notify of Certificate of Analysis Response

DTD XML Schema

Purpose: The purpose of this PIP is to response to the Certification of Analysis Notification with its disposition status and to provide reason for those with “reject” and “pending” responses.

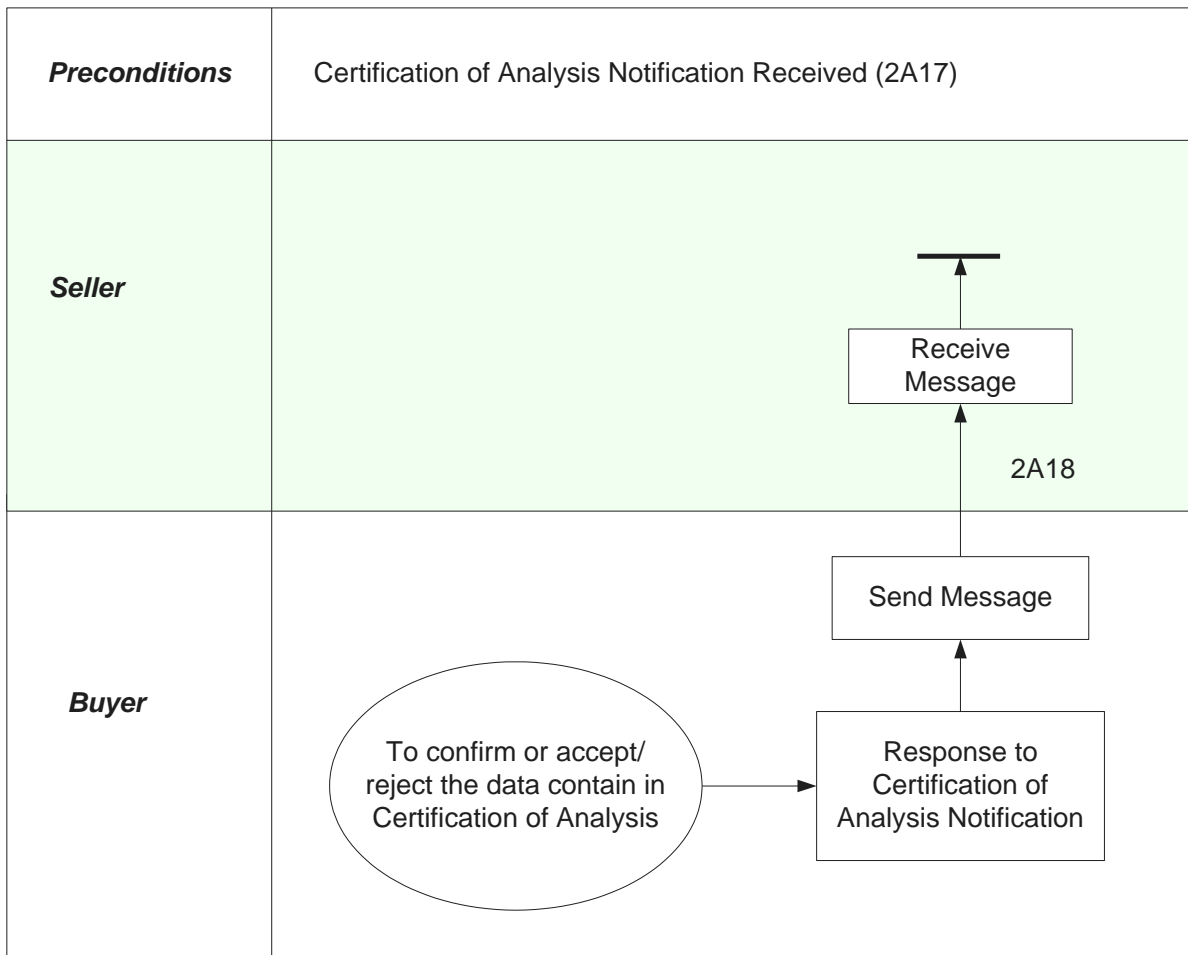

Note: RosettaNet Implementation Guides is available for PIP 2A18 version V11.00.00 (XML Schema).

5.2 Segment 2B: Product Change Notification

This segment enables update of product resources.

5.2.1 PIP 2B1: Change Basic Product Information

DTD XML Schema

Purpose: To provide a process for a Product Information Distributor to announce a change in product information to a Buyer. Furthermore, this PIP ensures that the Product Information Distributor will receive confirmation that the Buyer entered the changed product information in the system of record.

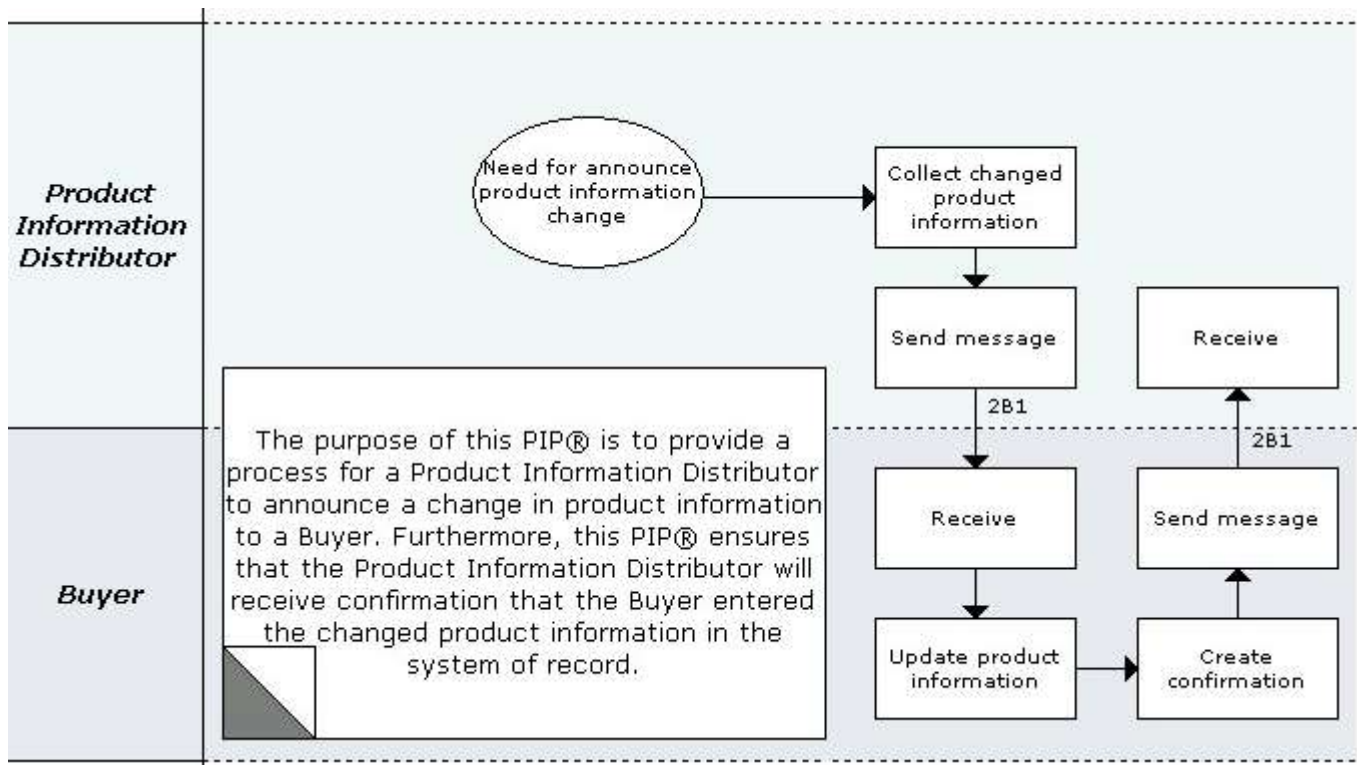

5.2.2 PIP 2B2: Change Marketing Information

DTD XML Schema

Purpose: To provide a mechanism for a Product Information Distributor to announce a product marketing information change to a Buyer. Furthermore, this PIP ensures that the Product Information Distributor will receive confirmation that the changed product marketing information was made by the Buyer.

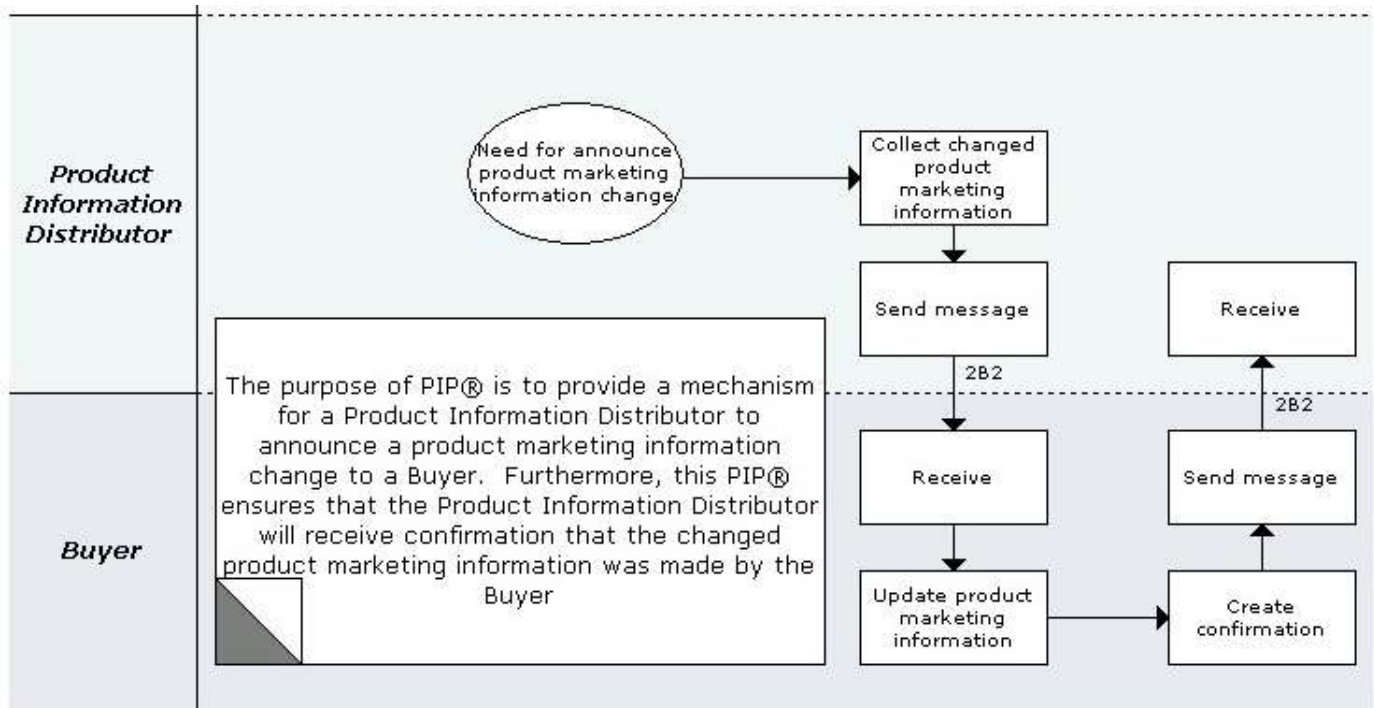

5.2.3 PIP 2B3: Change Sales Promotion & Rebate Information

DTD XML Schema

Purpose: To provide a mechanism for a Product Information Distributor to announce a change in Sales Promotion and Rebate Information to a Buyer. Furthermore, this PIP ensures that the Product Information Distributor will receive confirmation that the changed Sales Promotion and Rebate Information was made by the Buyer.

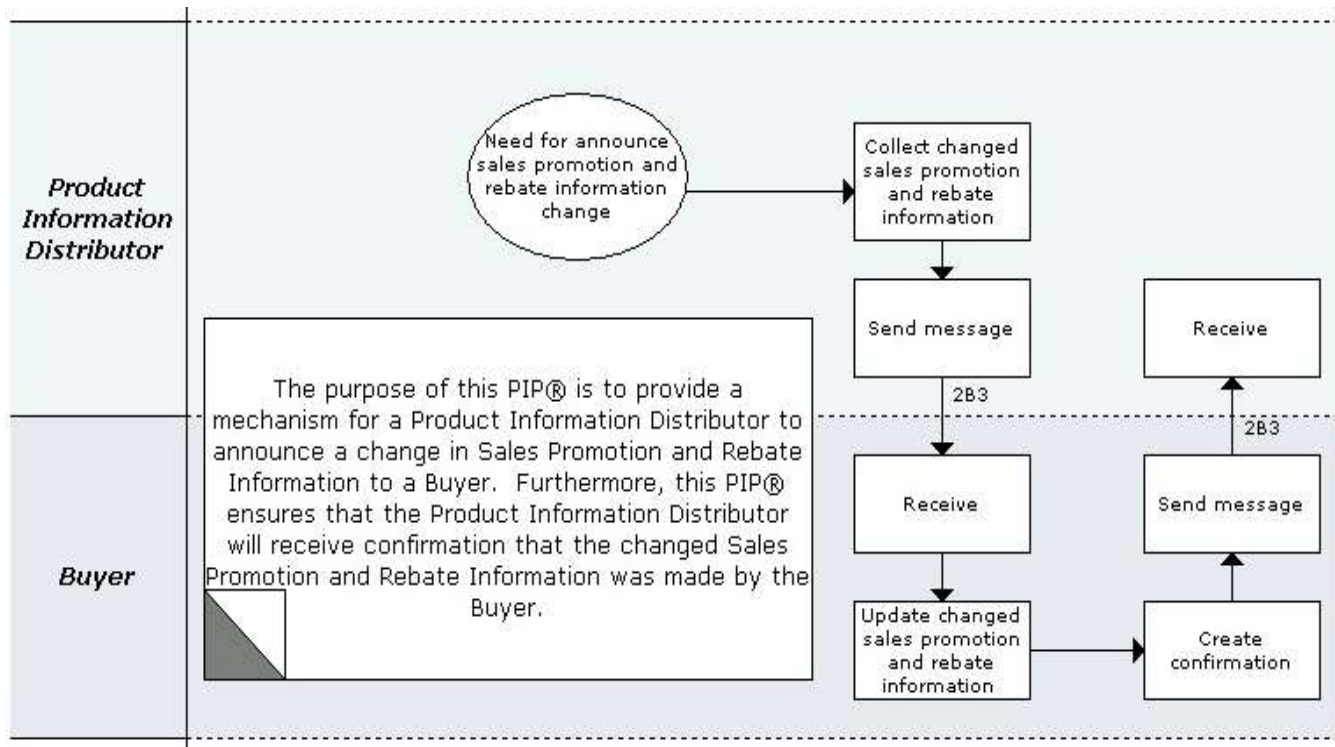

5.2.4 PIP 2B4: Change Product Technical Information

DTD XML Schema

Purpose: To provide a mechanism for a Product Information Distributor to announce a Product Technical Information change to a Buyer. Furthermore, the PIP ensures that the Product Information Distributor will receive confirmation that the changed Product Technical Information was made by the Buyer.

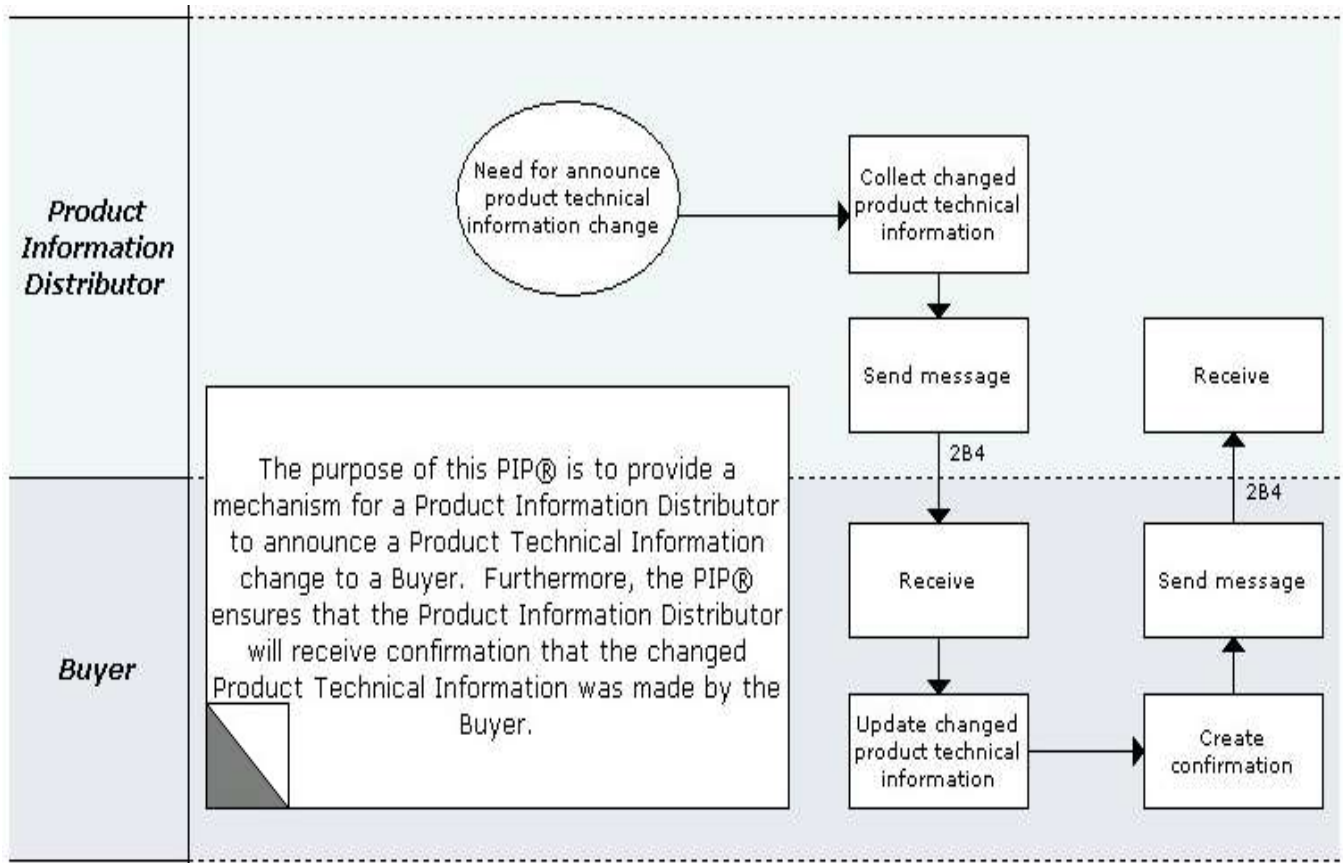

5.2.5 PIP 2B5: Change Product Lifecycle Information

DTD XML Schema

Purpose: To provide a mechanism for a Product Information Distributor to announce a Product Lifecycle Information change to a Buyer. Furthermore, the PIP ensures that the Product Information Distributor will receive confirmation that the changed Product Lifecycle Information was made by the Buyer.

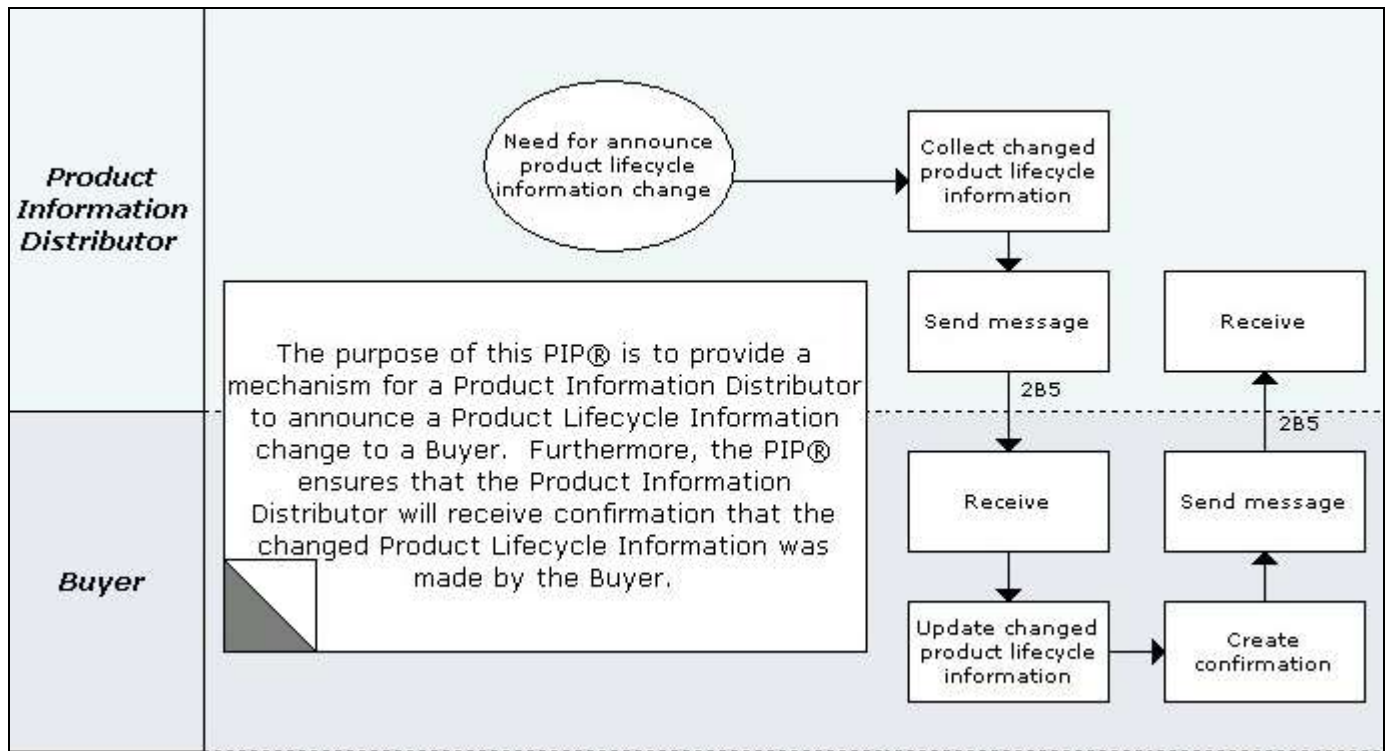

5.2.6 PIP 2B7: Notify of Product Change

DTD XML Schema

Purpose: To allow the supplier to notify customers of impending change or obsolescence. This is the initiation or triggering of a product change / EOL event. It is always triggered by the supplier and the recipient is always a customer or an agent acting on behalf of a customer. In most cases, both supplier and customer have a system or database that they will be extracting the data from (supplier) or inputting the data into (customer). These "back-end" systems are most commonly developed in-house, although there are commercially available PCN tools.

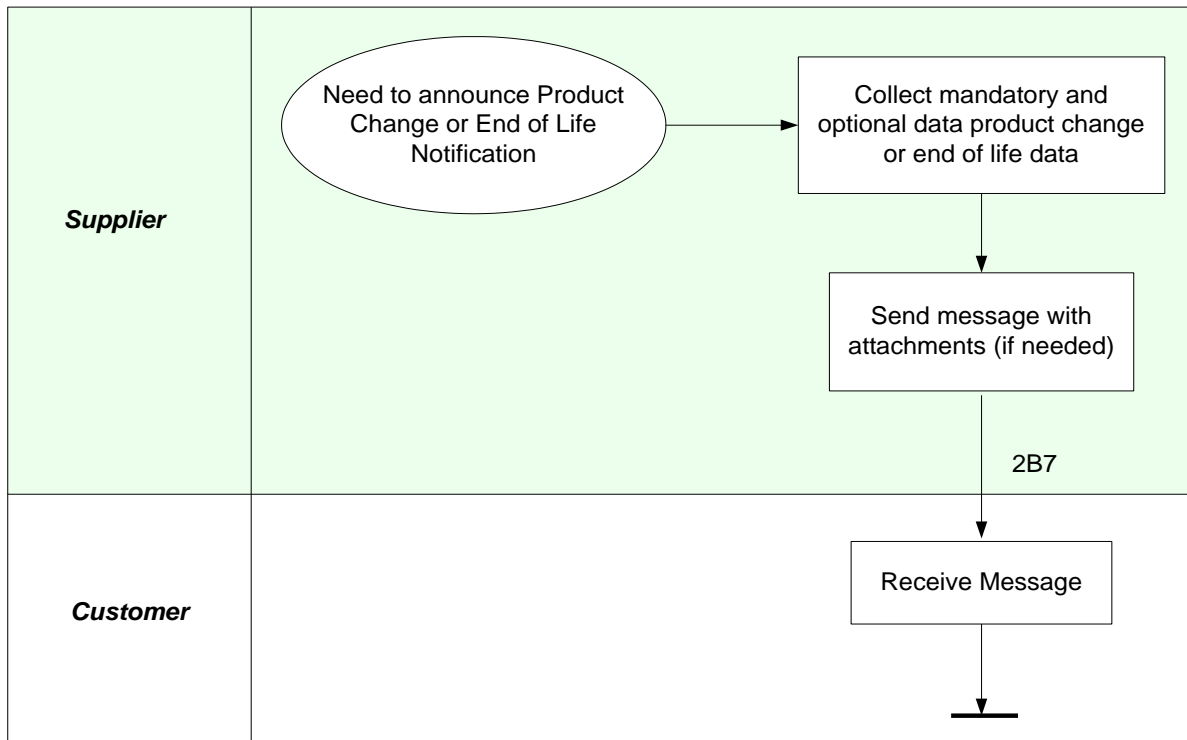

5.2.7 PIP 2B8: Notify of Product Change Query

DTD XML Schema

Purpose: This PIP allows customer to notify supplier that they cannot proceed with an accept/ reject decision on a PCN or EOL until the query has been satisfied. This is an optional event wherein the customer may require additional information from the supplier in order to be able to make the accept / reject decision regarding the notice. It is always triggered by the customer or customer’s agent, and it requires a response from the supplier in every case.

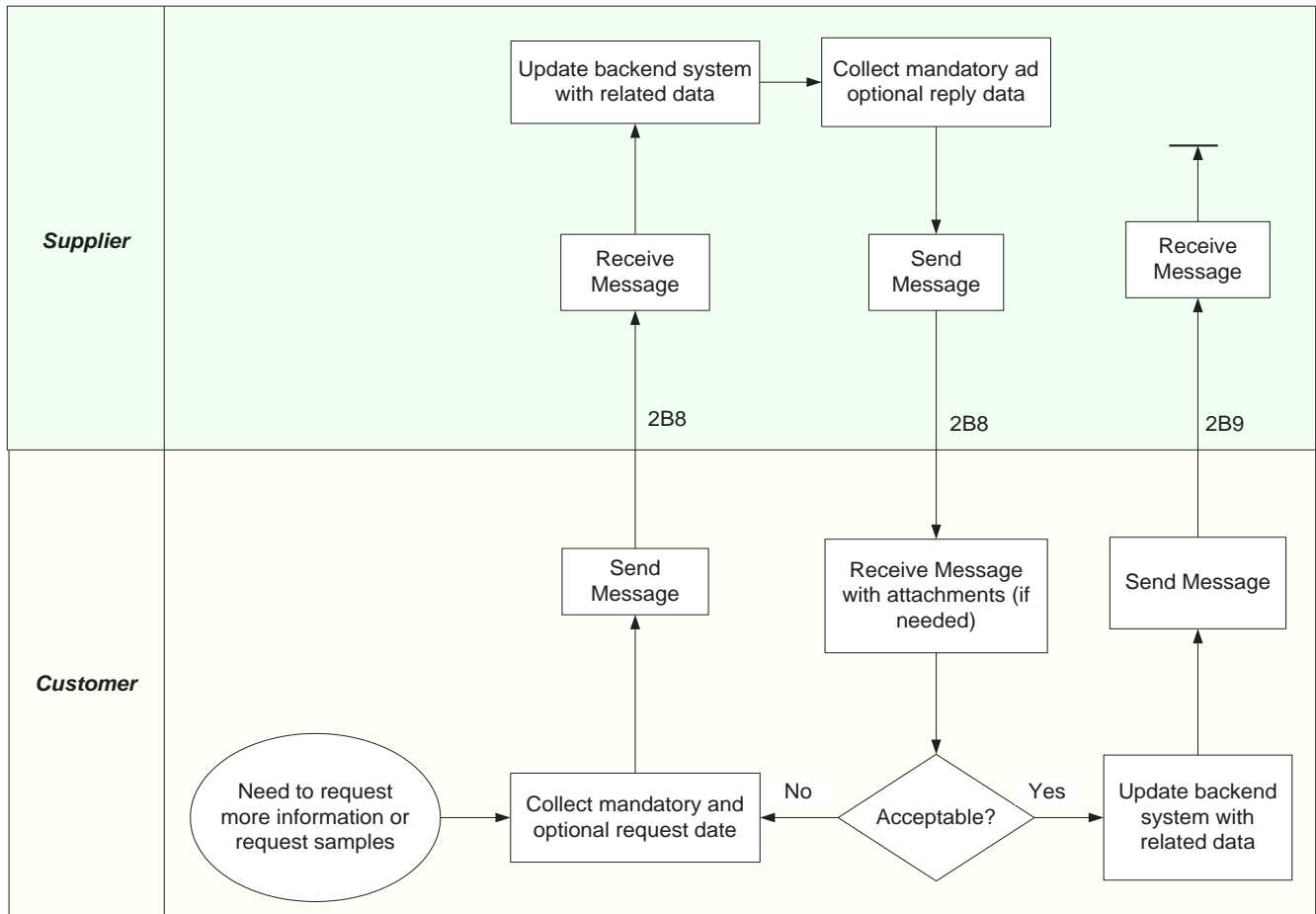

5.2.8 PIP 2B9: Notify of Product Change Acceptance

DTD XML Schema

Purpose: This is the acceptance / rejection of a product change / EOL event which typically triggered by the customer. It is an optional event, and when it is used as an acceptance it is unconditional.

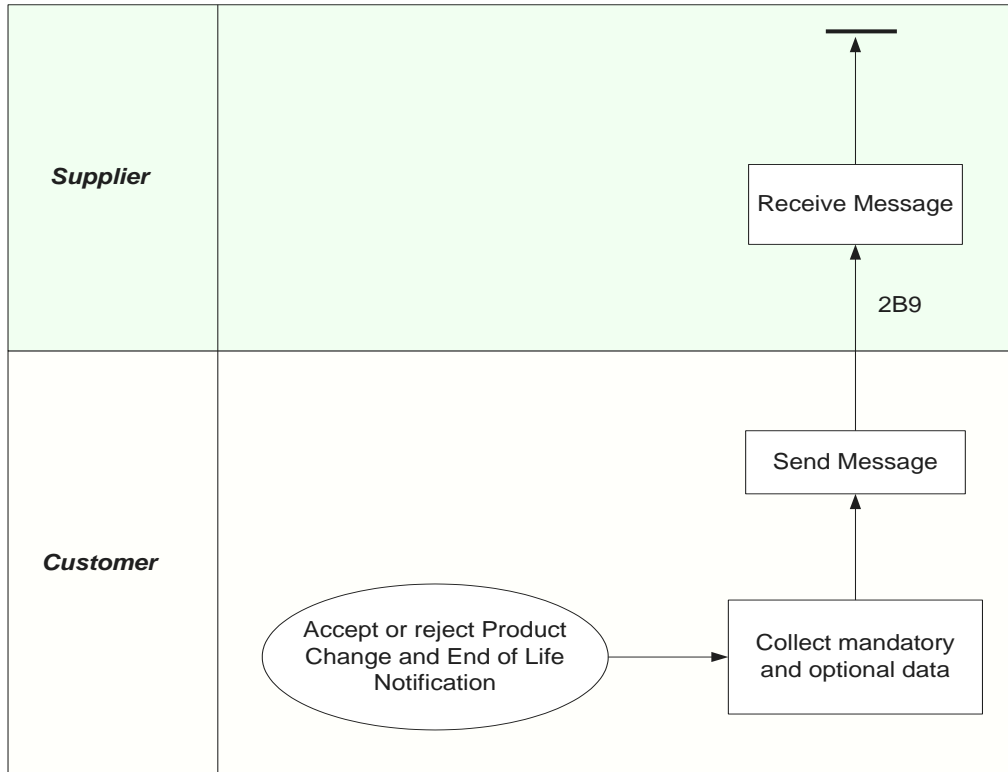

5.3 Segment 2C: Product Design Information

This segment enables release and update of product engineering design information.

5.3.1 PIP 2C1: Distribute Engineering Change Status

DTD XML Schema

Purpose: To enable a stakeholder to modify the disposition of an engineering change, and then notify the engineering change requester of the change in status. A change in status can occur anywhere along the business path of the engineering change. When the engineering change status is modified, the disposition must be provided (via this PIP®) within three days.

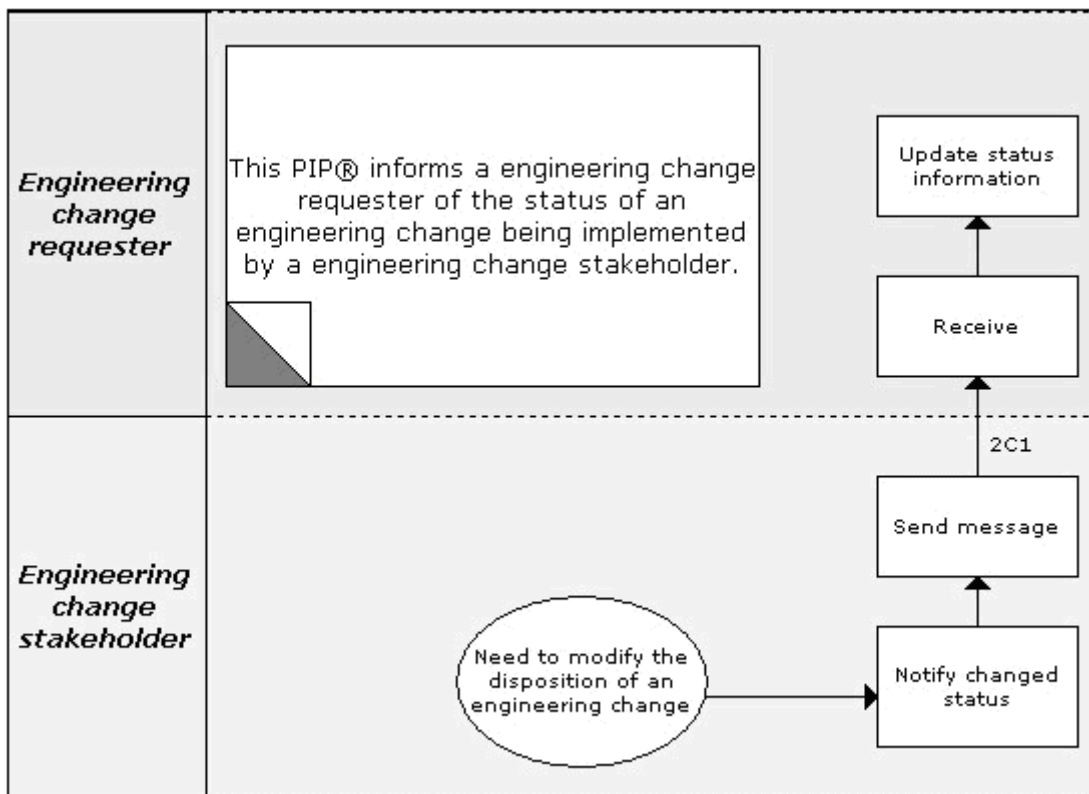

5.3.2 PIP 2C2: Request Engineering Change

DTD XML Schema

Purpose: To enable a party proposing an engineering change (change requester) to send an engineering change request to a change review forum, and the change review forum to respond to the request. The party requesting the change (change requester) submits an engineering change request when a stakeholder identifies an opportunity or problem requiring an engineering evaluation. The change review forum responds by either accepting, rejecting, or pending the engineering change request.

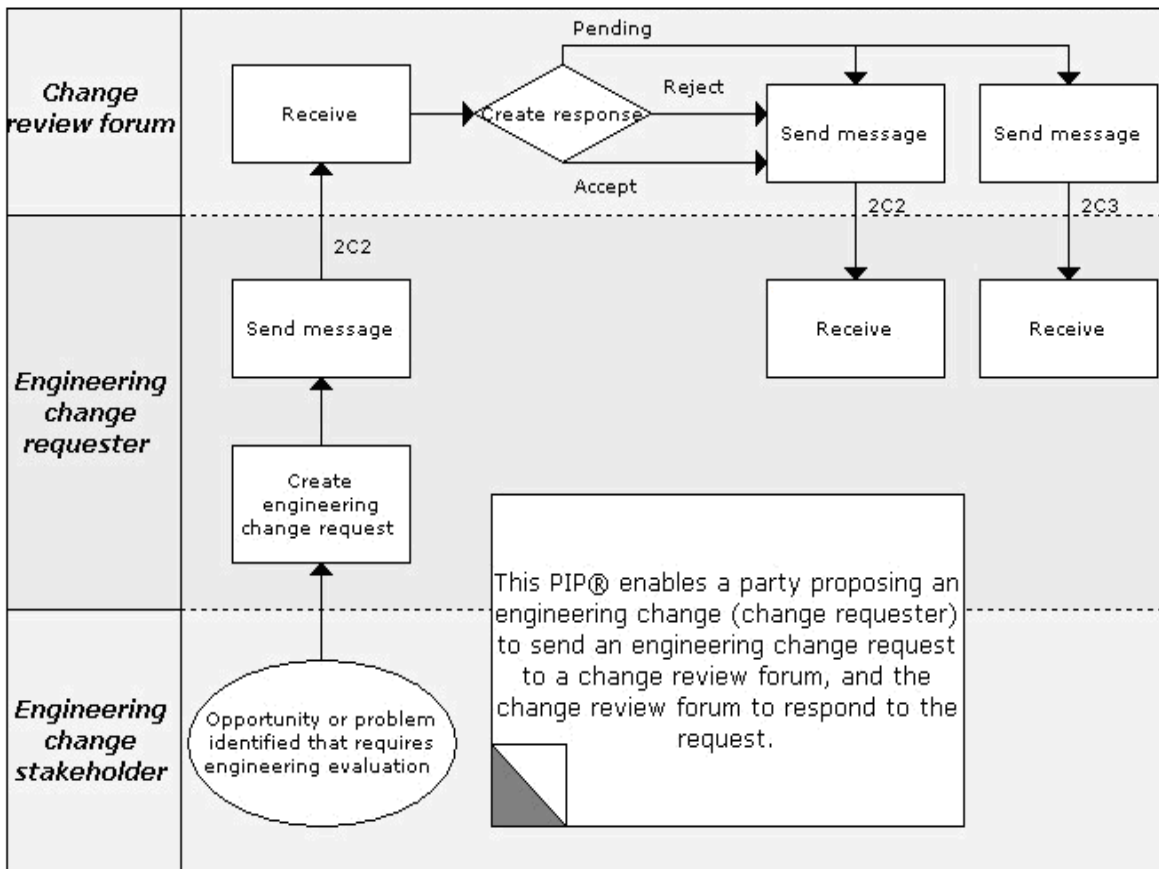

5.3.3 PIP 2C3: Distribute Engineering Change Response

DTD XML Schema

Purpose: To resolve a pending engineering change request by sending the change review forums final disposition (approve or reject) to the party that submitted the request (change requester).

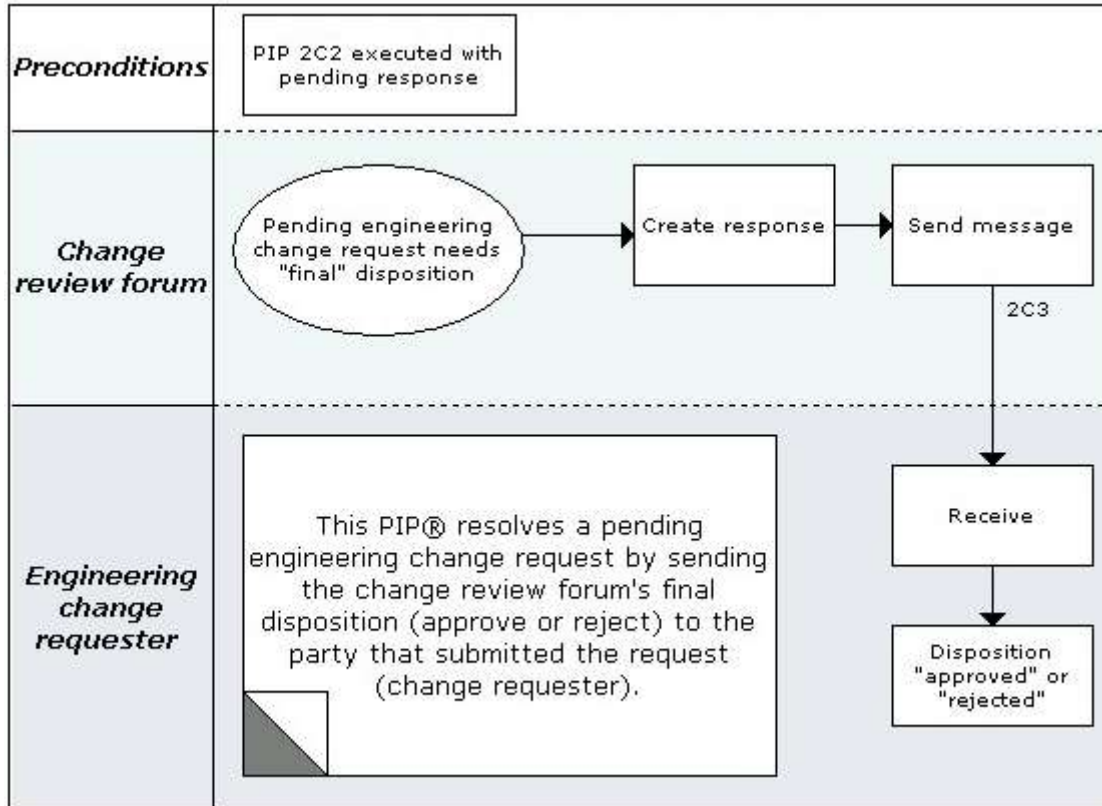

5.3.4 PIP 2C4: Request Engineering Change Approval

DTD XML Schema

Purpose: To allow a decision stakeholder to approve an engineering change that has been submitted to a change review forum for evaluation. Additionally, it can also be used to obtain a response from a decision stakeholder who belongs to an organization external to the change review forum. Approval responsibility includes a number of possible responses: approve, reject, waiver, and other options.

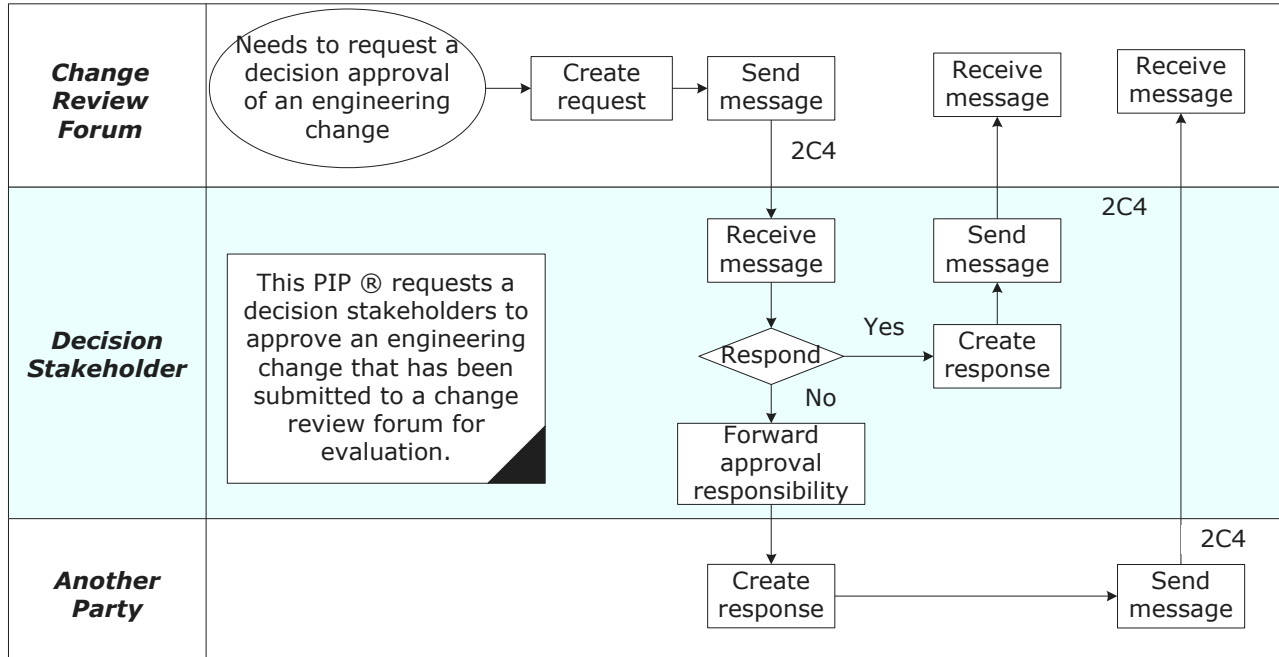

5.3.5 PIP 2C5: Notify of Engineering Change Order

DTD XML Schema

Purpose: It enables a change review forum to notify a stakeholder of the purpose and contents of an engineering change order. It includes a full description of the ECO and any associated documents. Optional text and documents may either be attached to the notification or accessed through uniform resource locator (URL) links embedded in the notification.

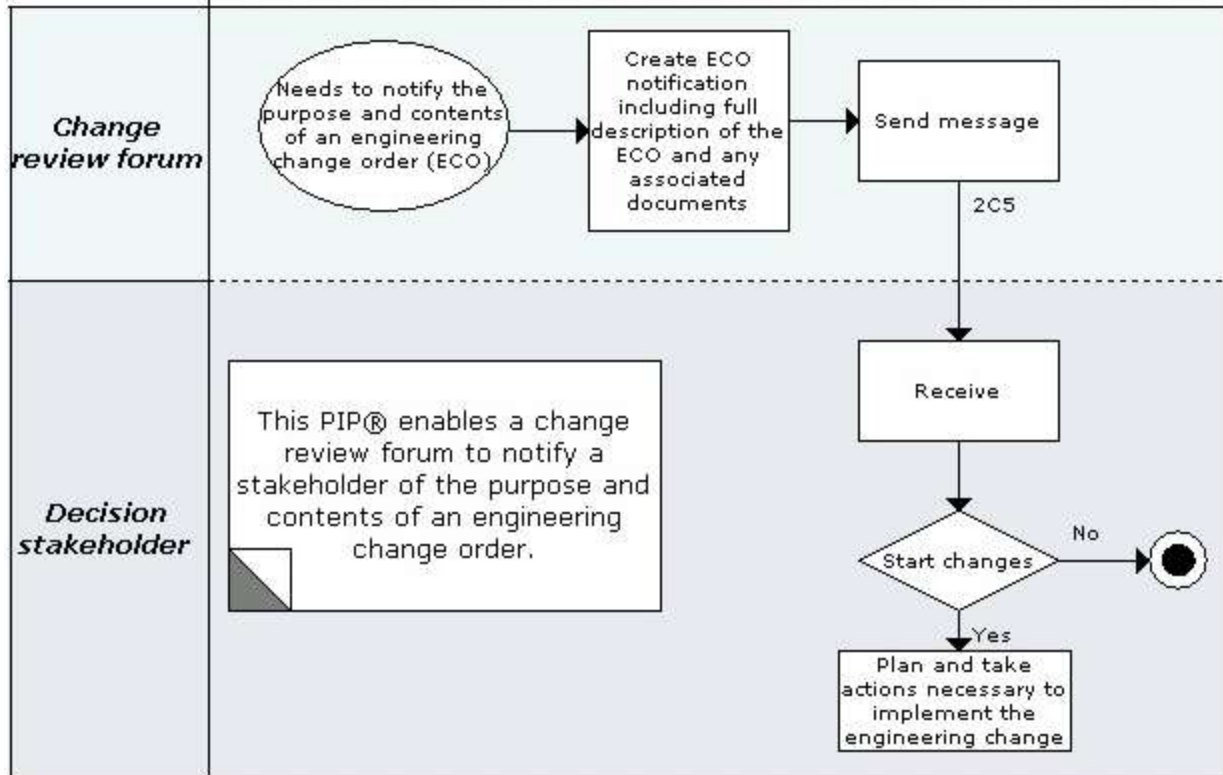

5.3.6 PIP 2C6: Notify of Engineering Change Implementation Plan

DTD XML Schema

Purpose: It enables coordination of engineering changes throughout the supply chain by providing the means to send engineering change implementation plans to the stakeholders who are responsible for performing or updating the status of a planned task. An engineering change implementation plan is a flexible document that may be iteratively updated to organize and track the individual tasks necessary to implement an engineering change order.

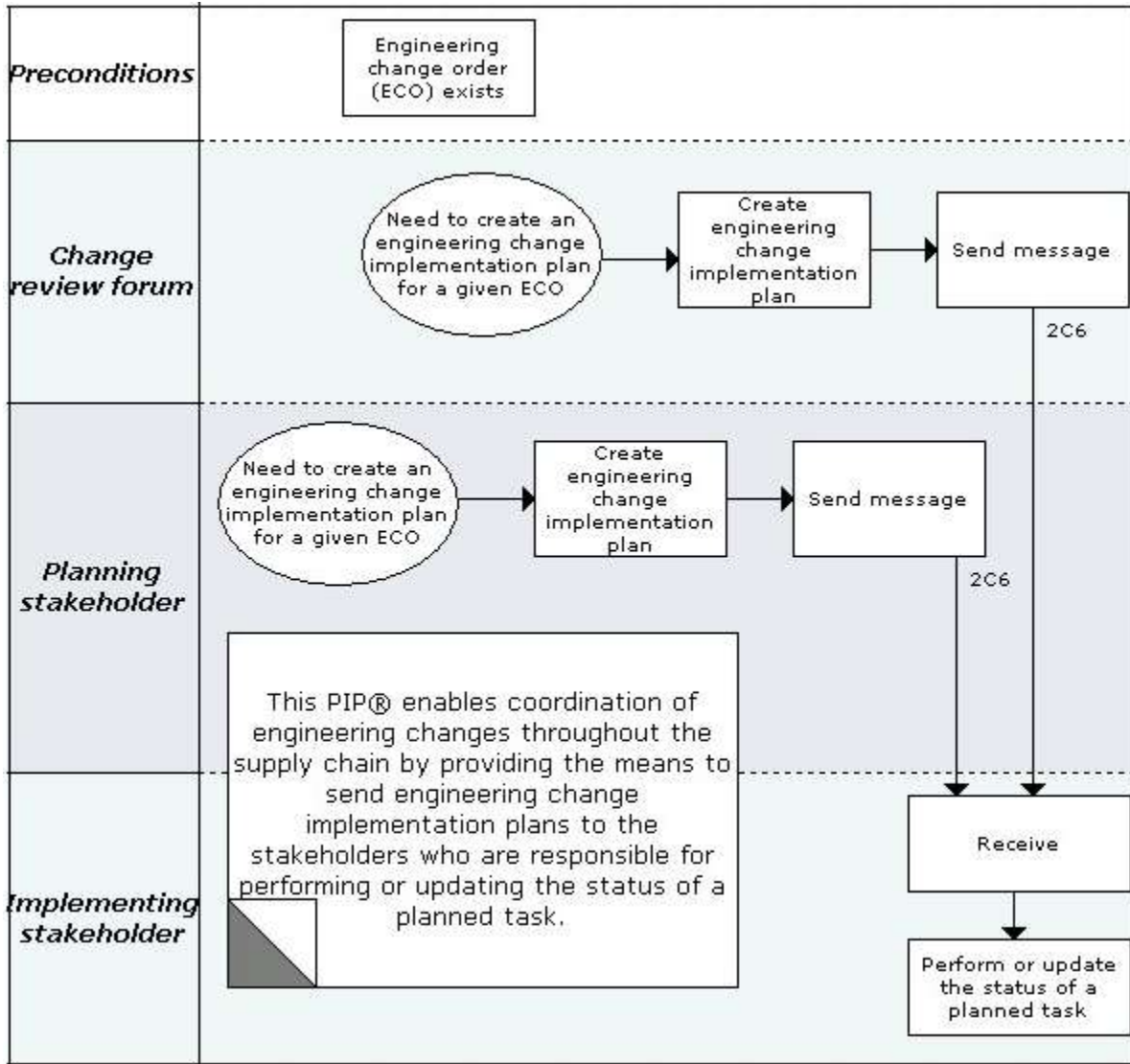

5.3.7 PIP 2C7: Request Bill of Material

DTD XML Schema

Purpose: Generally, this PIP is designed to easily and efficiently communicate BOM information about the parts that go into a product from engineering to manufacturing. Thus, it supports a process in which:

1. An Integrator requests the Bill of Material (BOM) information for a product.
2. The Design Owner for that product returns the requested information to the Integrator.

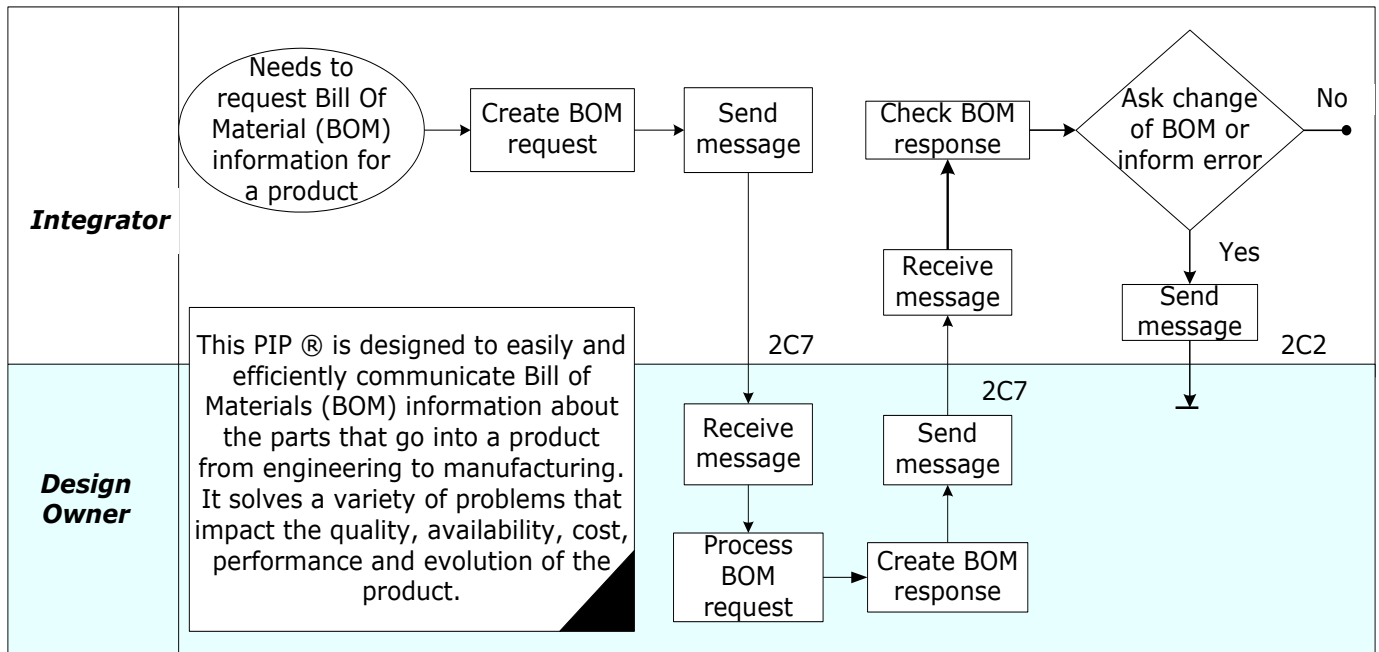

5.3.8 PIP 2C8: Notify of Bill of Material

DTD XML Schema

Purpose: To support a process in which a Design Owner shares Bill Of Material (BOM) information for a product with an Integrator. The Design Owner is the entity responsible for the design of the product and the Integrator is responsible for its manufacture or assembly.

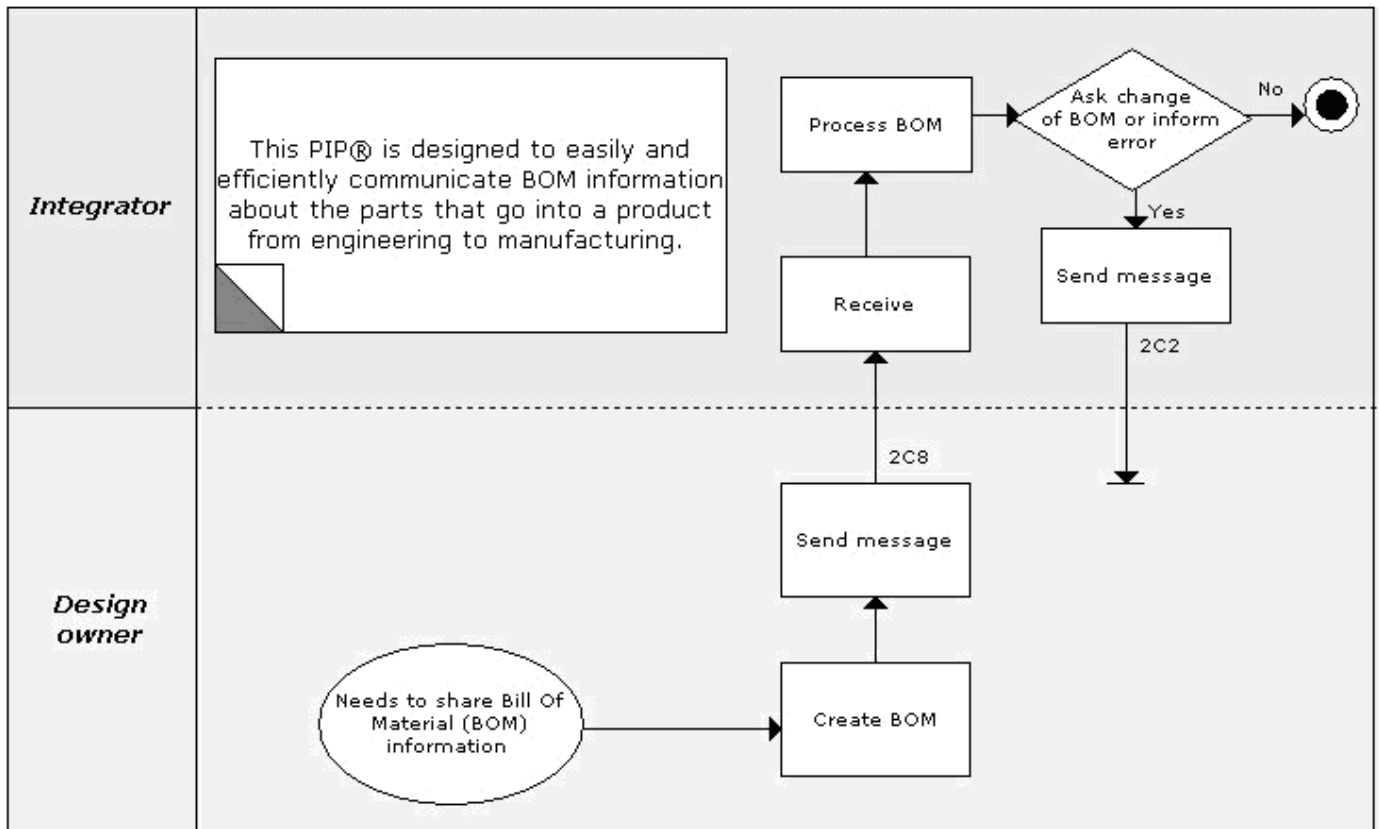

5.3.9 PIP 2C9: Request Approved Manufacturer List

DTD XML Schema

Purpose: To communicate Approved Manufacturer List (AML) information about the parts that are approved for a product from engineering to manufacturing. It supports the exchange of mappings from internal part numbers to manufacturer part numbers, where manufacturer is loosely defined as the last partner to affect a change to the part. It also supports the mapping of these part numbers to supplier part numbers. The AML solves a variety of problems that impact quality, costing and lead times. Quality is improved by specifying precise definitions of the parts that are approved and the suppliers that are approved to supply them. The AML assists in costing and in planning lead times. The AML provides traceability into the process of part acquisition. The AML also allows the Integrator to respond whether it is able to build the product.

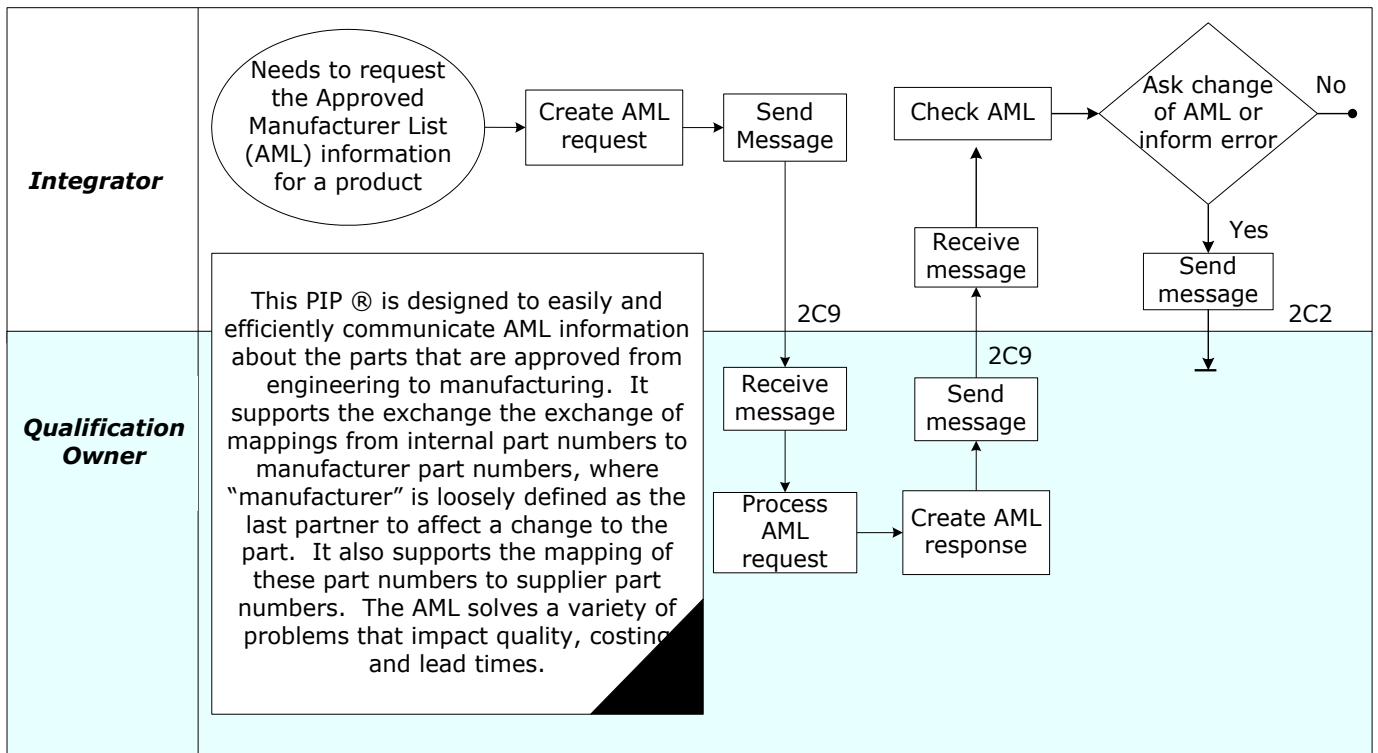

5.3.10 PIP 2C10: Notify of Approved Manufacturer List

DTD XML Schema

Purpose: To support a process in which a Qualification Owner shares an Approved Manufacturer List (AML) for a product with an Integrator. The Qualification Owner is the entity responsible for qualifying parts that are approved for manufacture of the product and qualifying suppliers that are approved for acquiring these parts. The Integrator is responsible for the product's manufacture or assembly.

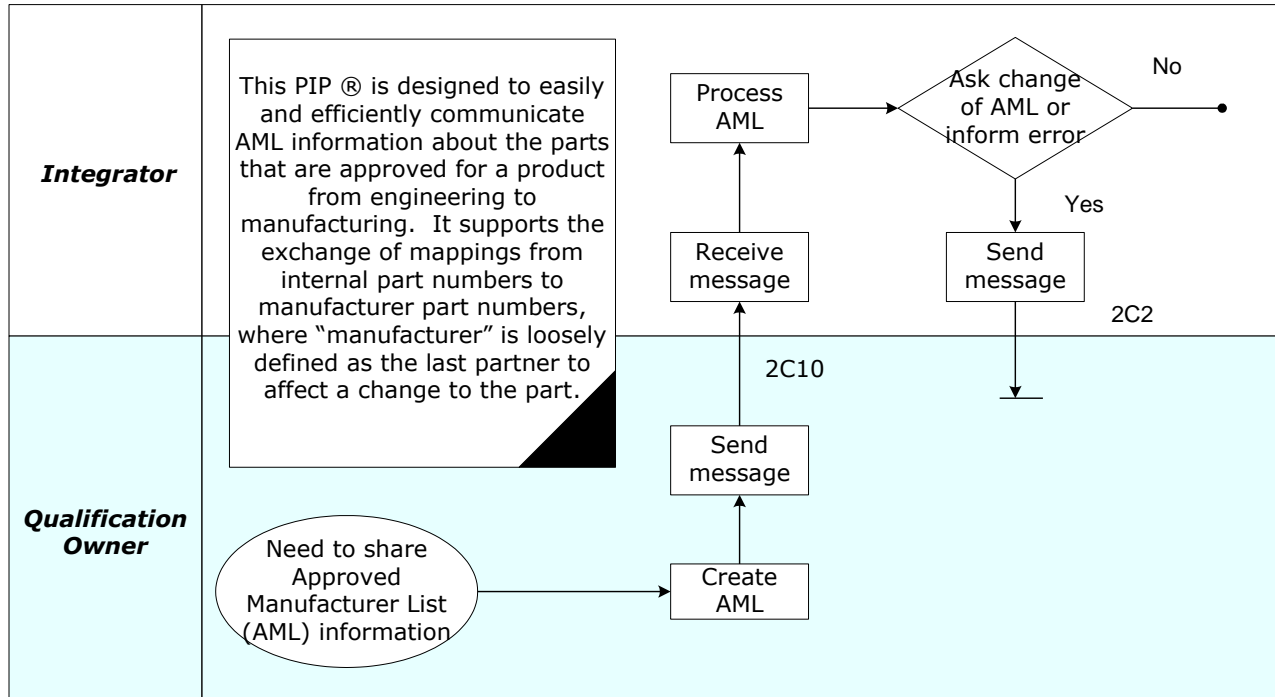

6 Cluster 3: Order Management

This cluster supports full order management business area from price and delivery quoting through purchase order initiation, status reporting, and management. Order invoicing, payment and discrepancy notification also managed using this Cluster of processes.

6.1 Segment 3A: Quote and Order Entry

This segment allows partners to exchange price and availability information, quotes, purchase orders and order status, and enables partners to send requested orders, or shopping carts, to other partners.

6.1.1 PIP 3A1: Request Quote

DTD XML Schema

Purpose: To support a process between trading partners that involves requesting and providing quotes which enables a buyer to request a product quote from a provider, and a provider to respond with either a quote or a referral. If referred to another provider, the buyer may request a quote from that party.

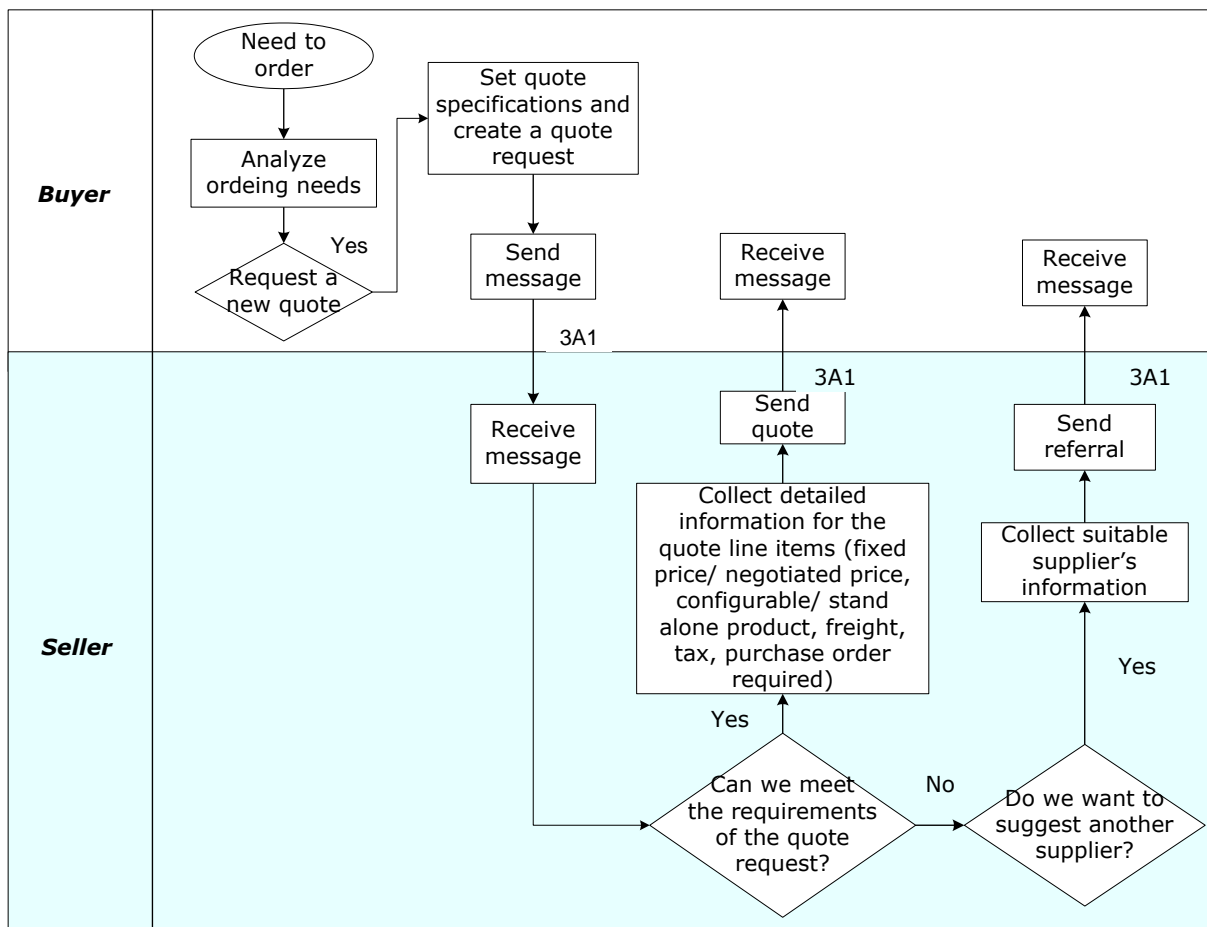

Note: RosettaNet Implementation Guides is available for PIP 3A1 version V02.00.00 (DTD) and version V11.10.00 (XML Schema).

6.1.2 PIP 3A2: Request Price and Availability

☒ DTD ☒ XML Schema

Purpose: To support a process between trading partners that involves requesting price and availability and providing said price and availability. This PIP is designed to be a very quick, automated way of obtaining price and availability for a product. Price and availability checks are less formal than quotes and usually not reconciled with purchase orders.

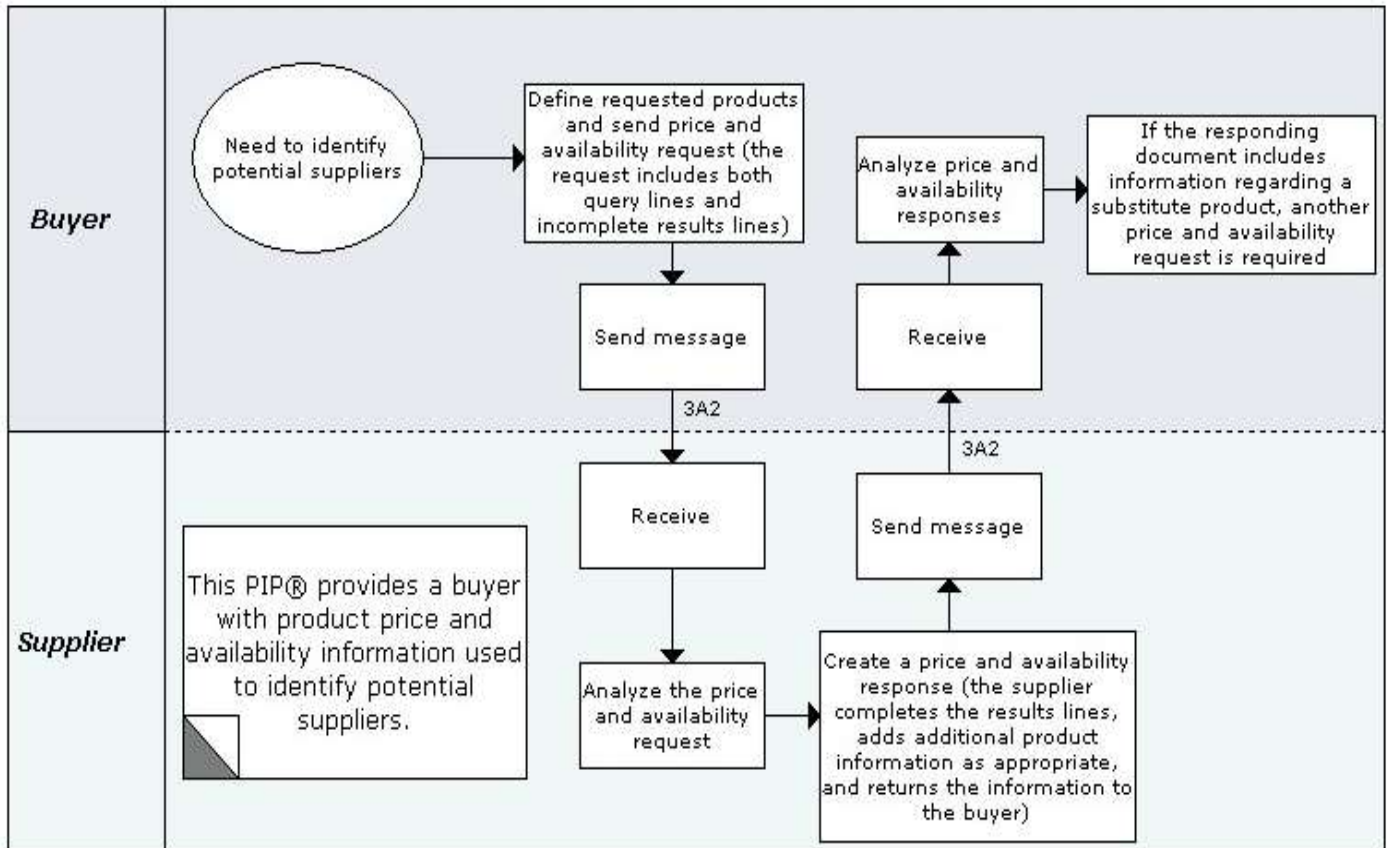

Note: RosettaNet Implementation Guides is available for PIP 3A2 version V02.00.00 (DTD).

6.1.3 PIP 3A3: Request Shopping Cart Transfer

DTD XML Schema

Purpose: To support a process between trading partners that involves transferring the contents of a shopping cart and replying to said transfer. All activities within the Shopping Cart Transfer PIP are automated activities that will be performed very quickly.

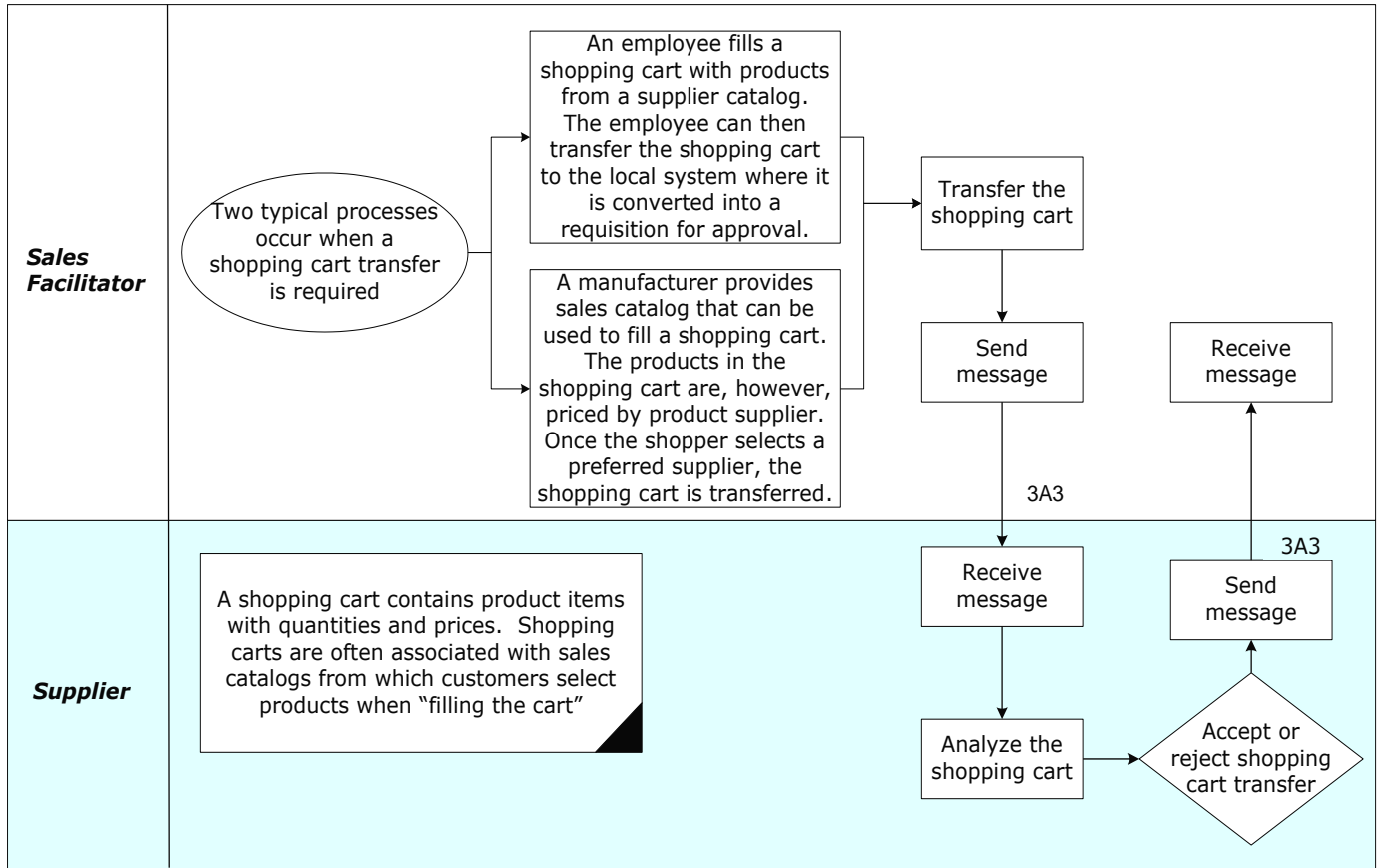

6.1.4 PIP 3A4: Request Purchase Order

☒ DTD ☒ XML Schema

Purpose: To support a process between trading partners that involves issuing a purchase order and acknowledging that purchase order. The PIP also supports the capability to cancel or change the purchase order based on the acknowledgment response and to acknowledge, at the line level, if the order is accepted, rejected, or pending.

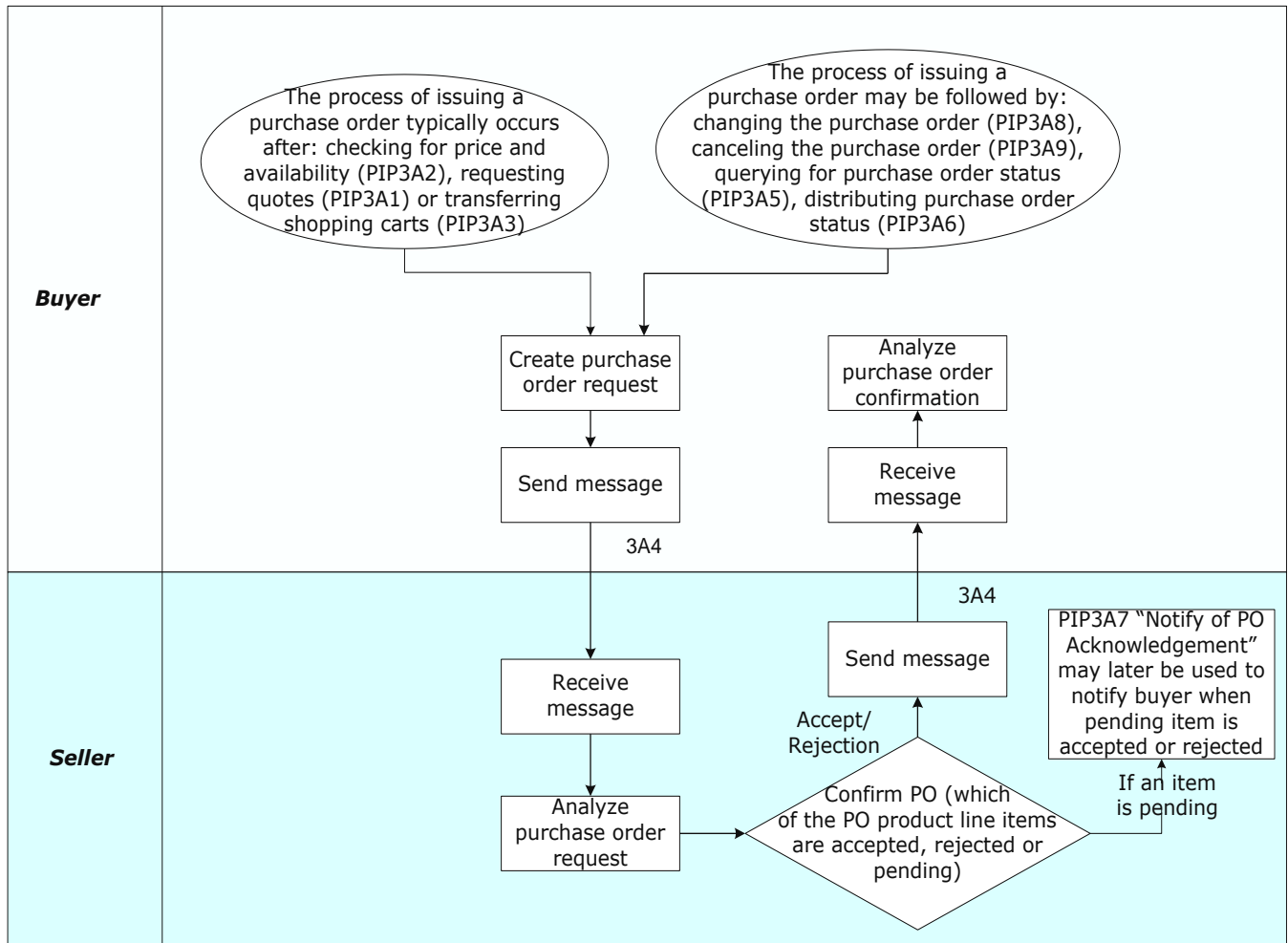

Note: RosettaNet Implementation Guides is available for PIP 3A4 version V02.03.00 (DTD) and version V11.10.00 (XML Schema).

6.1.5 PIP 3A5: Query Order Status

DTD XML Schema

Purpose: To support a process between trading partners for canceling or changing a purchase order and acknowledging changes, and to support an automated process for product sellers to report order status on all open orders on a periodic basis. Open orders are those that have not been completely shipped. Periodicity of reporting is agreed to between the partners in the trading agreement.

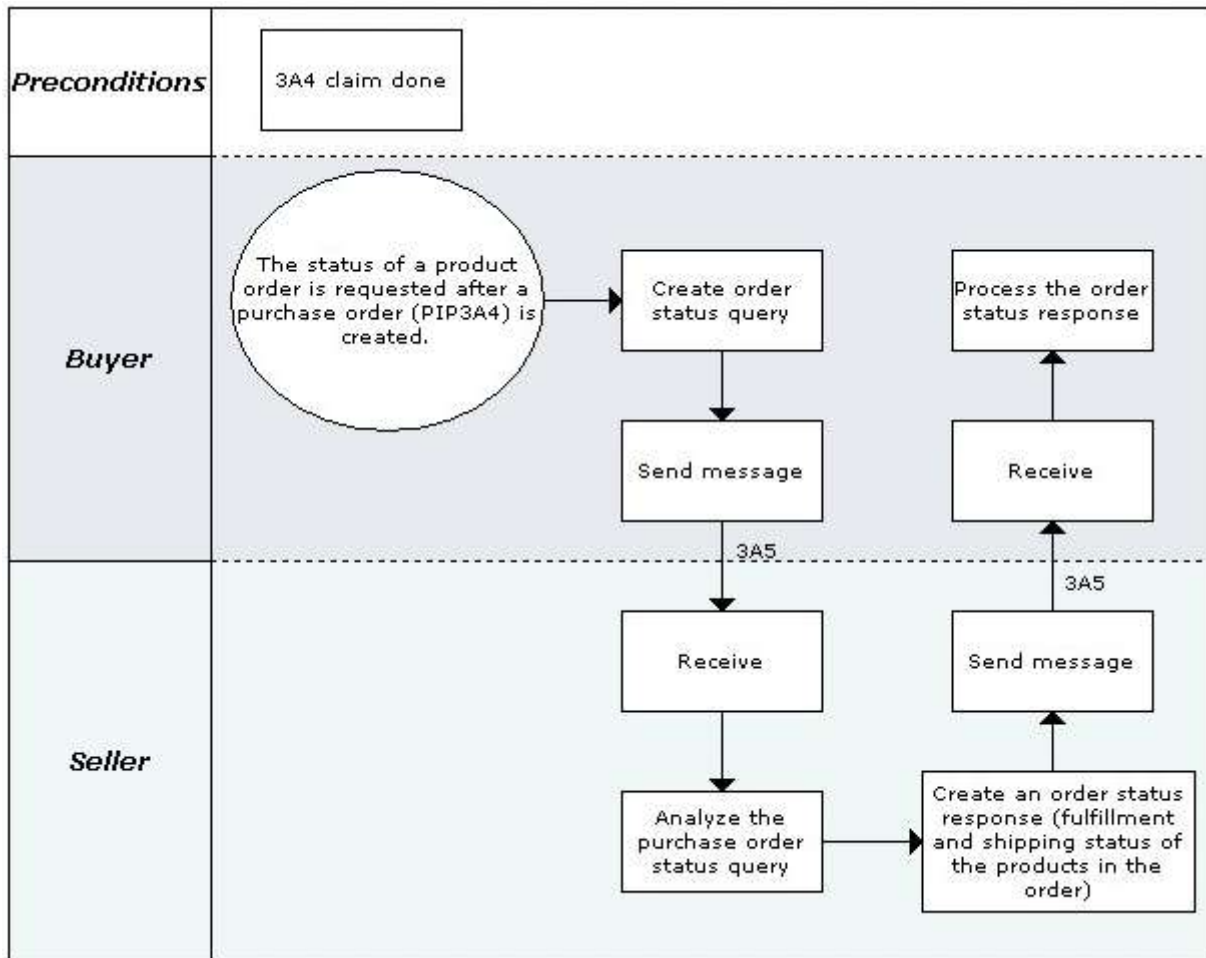

6.1.6 PIP 3A6: Distribute Order Status

DTD XML Schema

Purpose: To specify a process for Sellers to distribute order status to partners on a periodic basis. Only the status of open orders is distributed. Partners agree to reporting interval in the trading partner agreements.

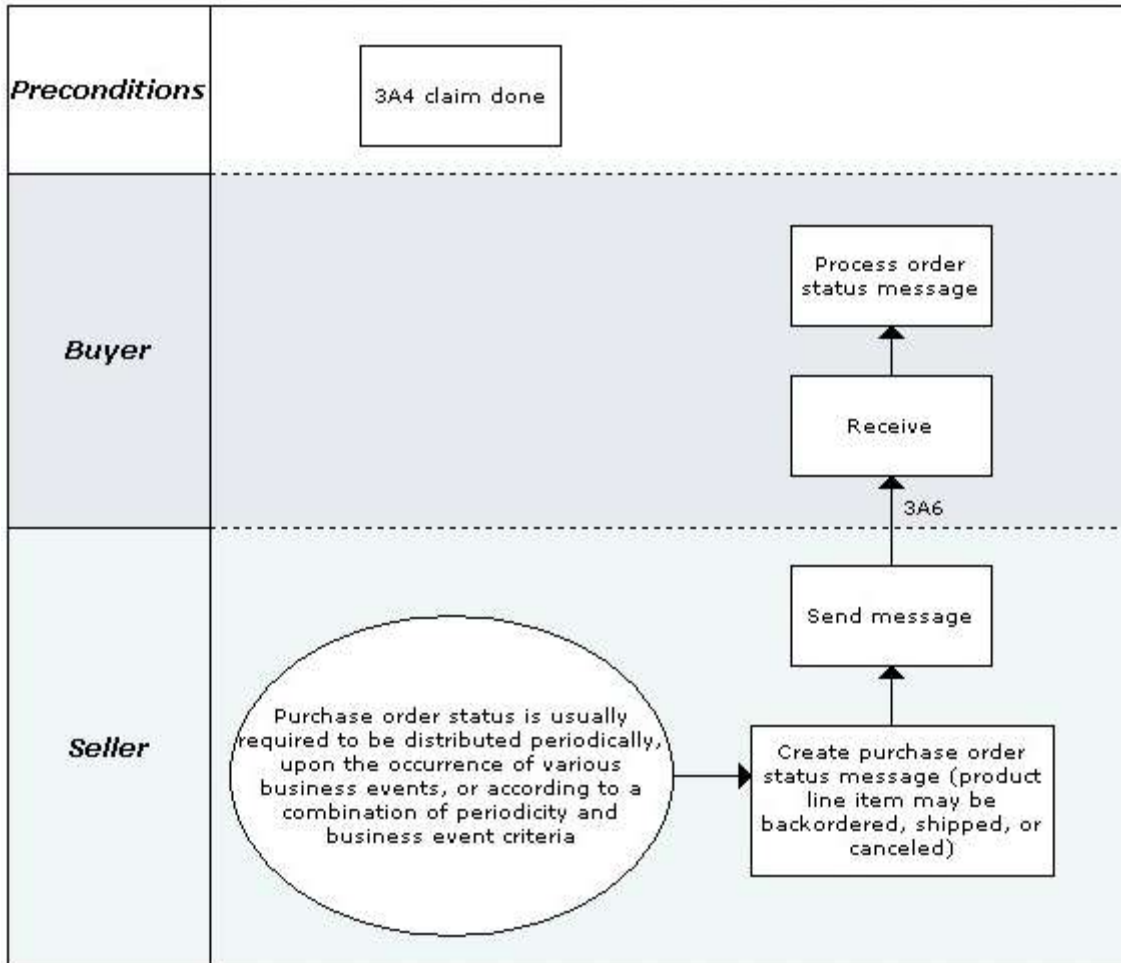

Note: RosettaNet Implementation Guides is available for PIP 3A6 version V02.02.00 (DTD).

6.1.7 PIP 3A7: Notify of Purchase Order Update

DTD XML Schema

Purpose: To specify a process for requesting Work in Process Response from a trading partner that contains the status of manufactured product. The Work in Process Response contains information on the production status of a product being manufactured. Also, it enables a seller to acknowledge acceptance or rejection of a pending line in a purchase order or a purchase order change which can be initiated by the seller.

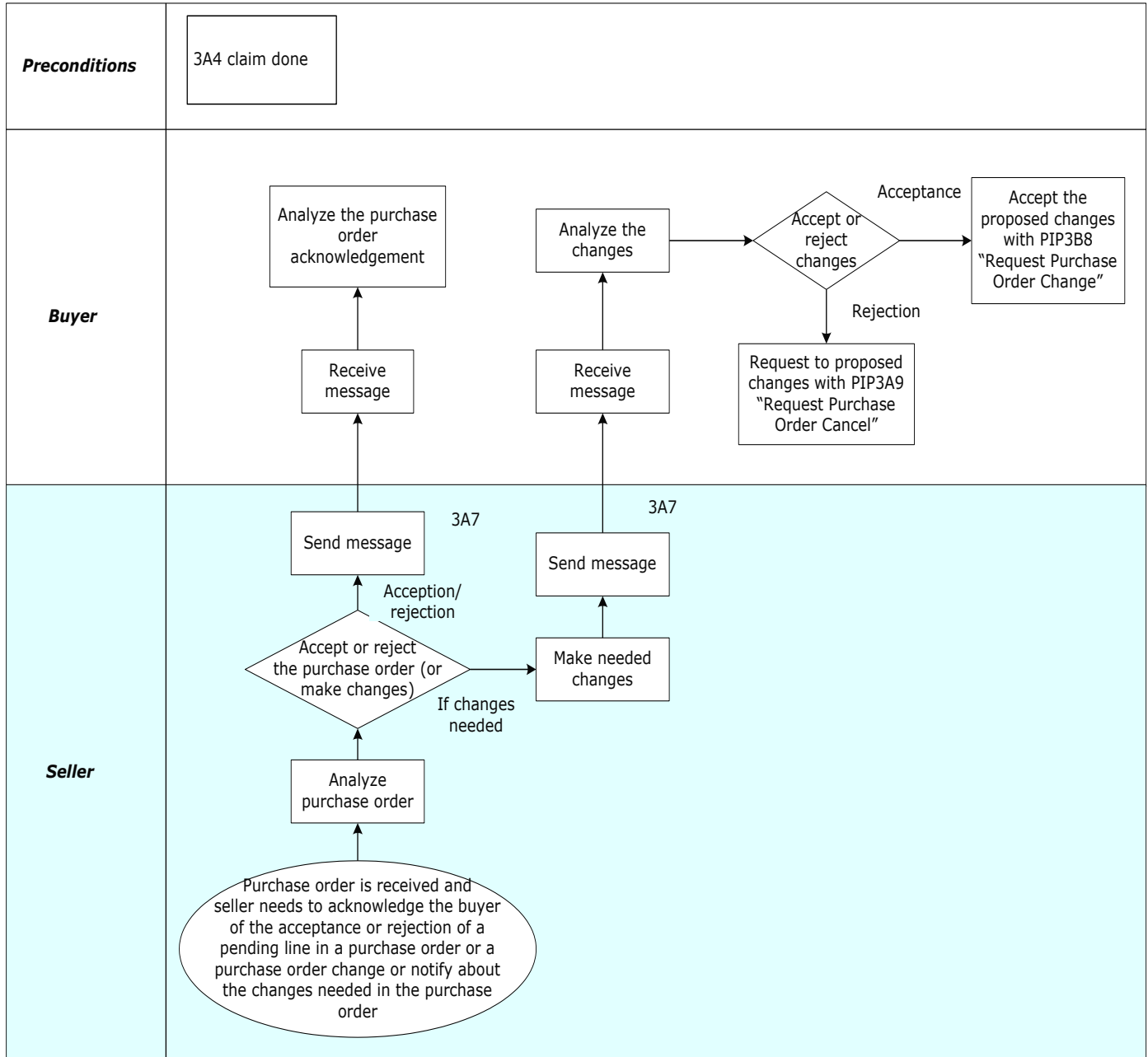

6.1.8 PIP 3A8: Request Purchase Order Change

☒ DTD ☒ XML Schema

Purpose: This enables a buyer to change purchase order line items and obtain a quick response from the provider that acknowledges, at the line level, if the changes are accepted, rejected, or pending. Changes to a purchase order may be initiated by the buyer or may occur after the receipt of a seller initiated change in PIP3A7, "Notify of Purchase Order Update."

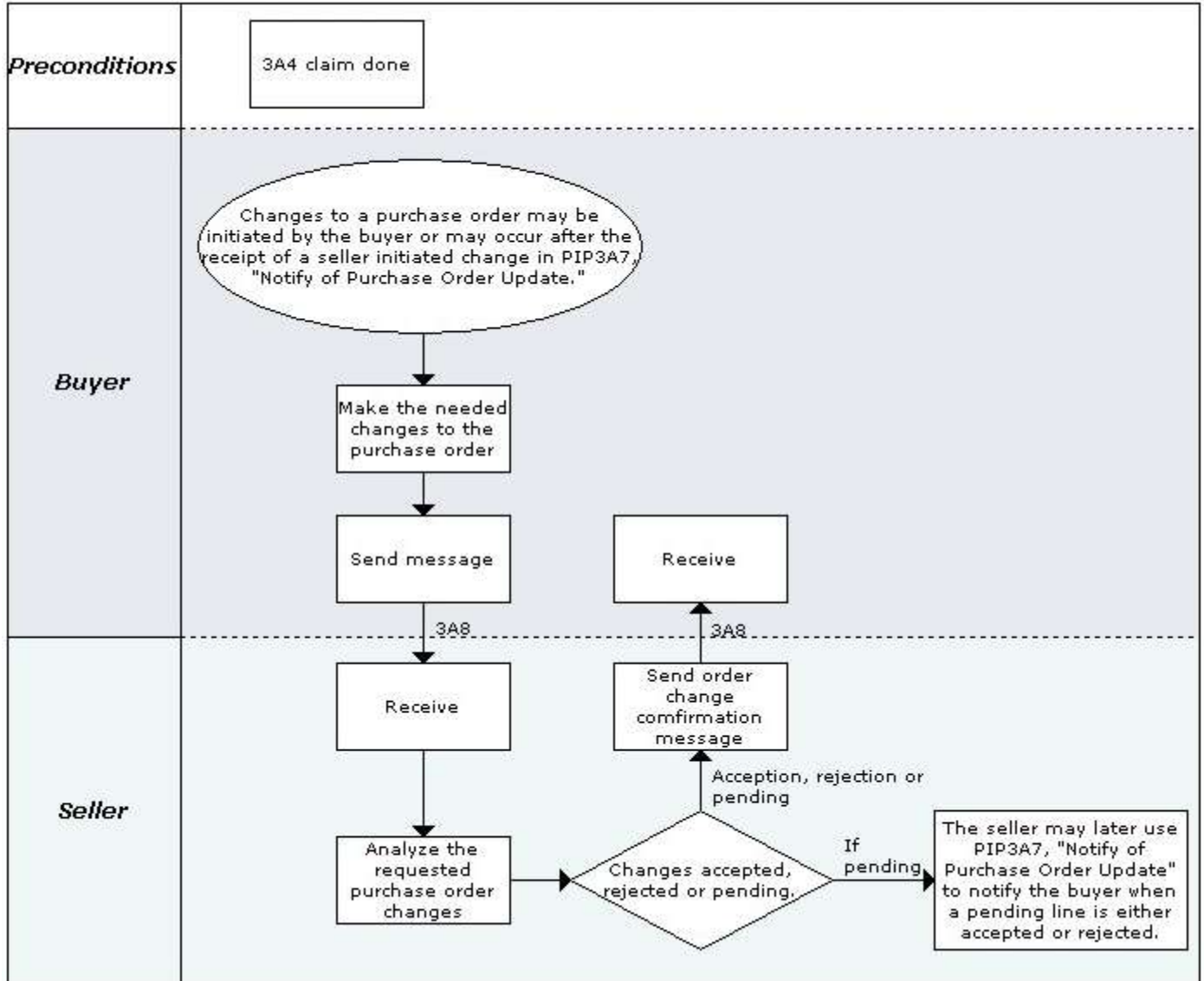

6.1.9 PIP 3A9: Request Purchase Order Cancellation

☒ DTD ☒ XML Schema

Purpose: This enables a buyer to cancel a purchase order and obtain a response from the provider that confirms if the cancellation is accepted or rejected.

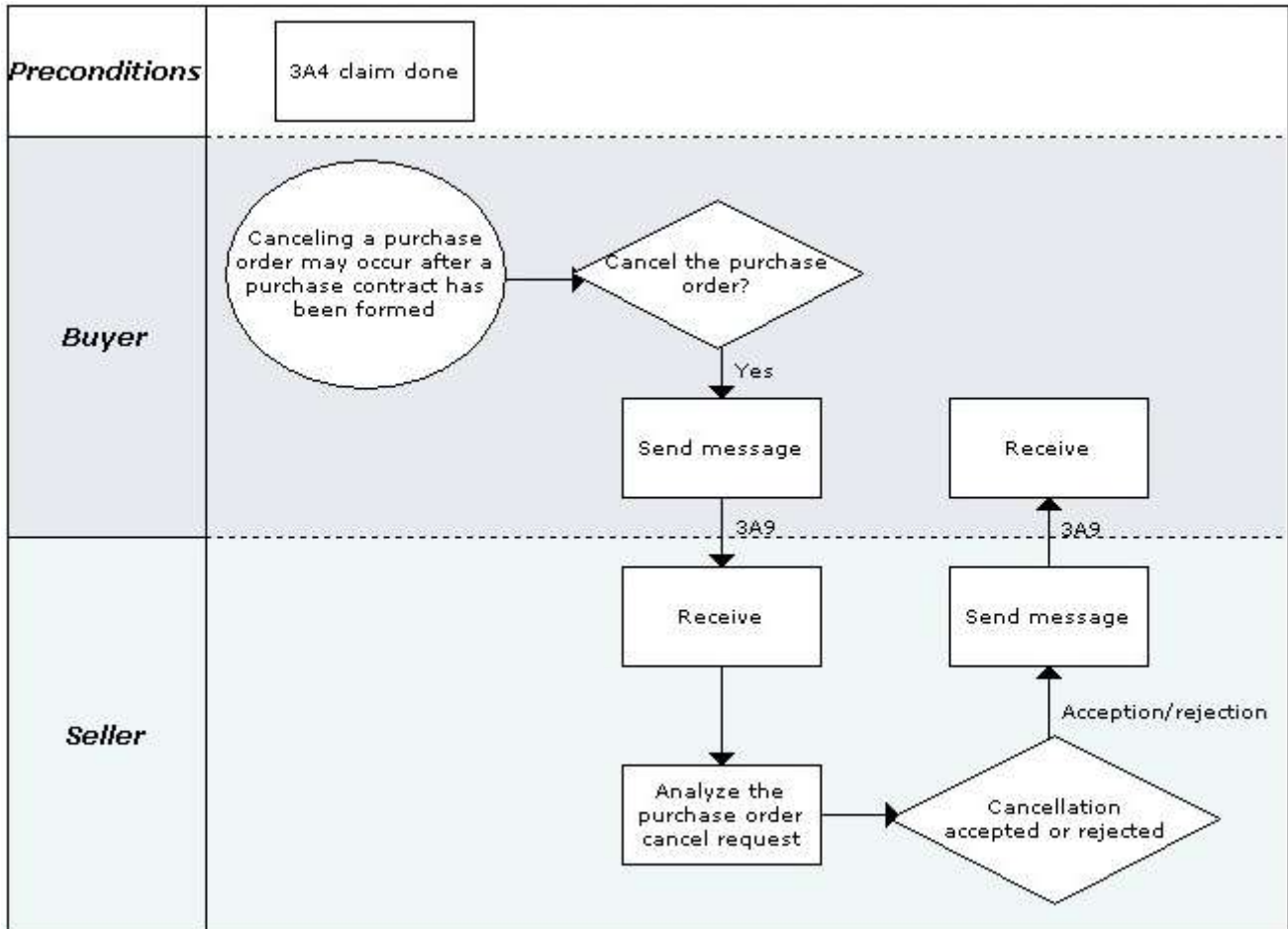

6.1.10 PIP 3A10: Notify of Quote Acknowledgement

DTD XML Schema

Purpose: This enables a Buyer to acknowledge (by PO product line number), acceptance (win) or rejection (loss) of a quote. A Buyer's acceptance (win) of the quotation issued by the Product Provider, is not an offer to buy, but is merely an invitation to do business.

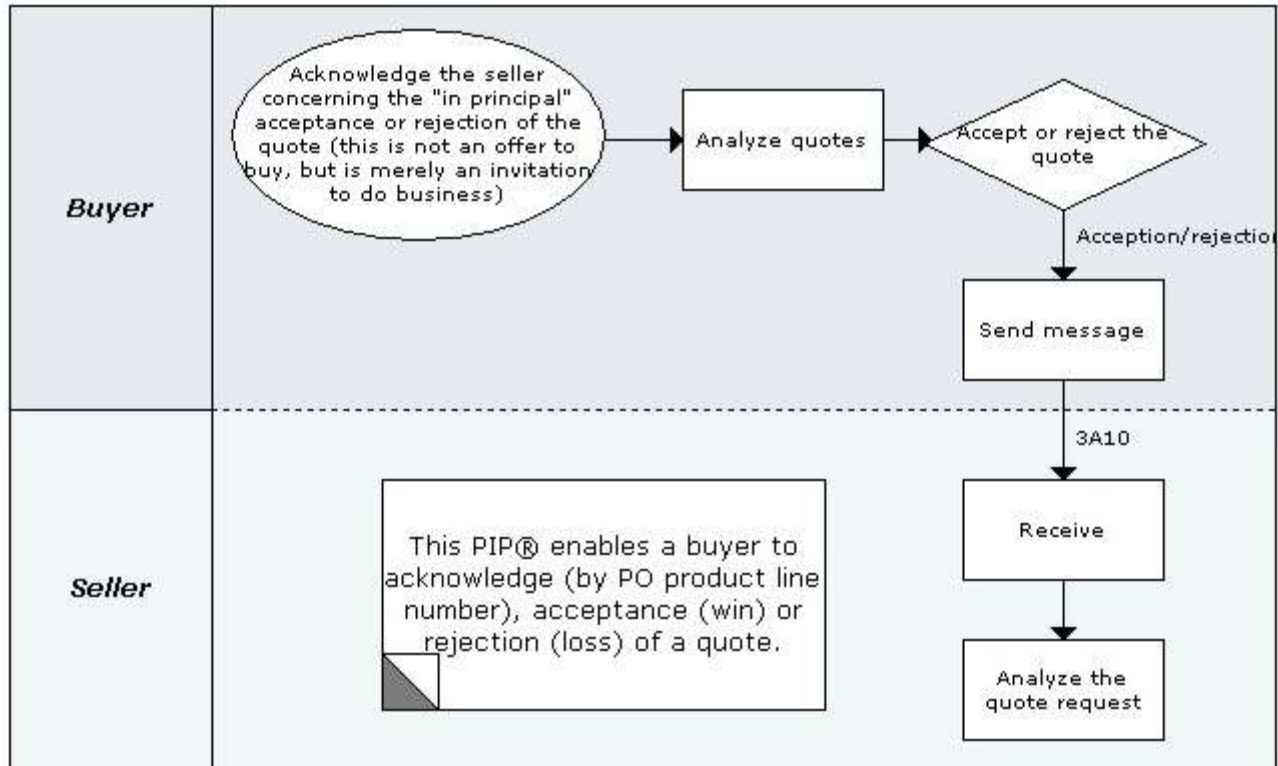

6.1.11 PIP 3A13: Notify of Purchase Order Information

☒ DTD ☒ XML Schema

Purpose: This is designed to enable a purchase order owner to communicate information about a purchase order to a party other than the purchase order recipient. The Buyer is the owner or initiator of the purchase order, the Seller is the recipient of the purchase order and the third party receiving the information about the purchase order is sometimes referred to as the Purchase Order Information User.

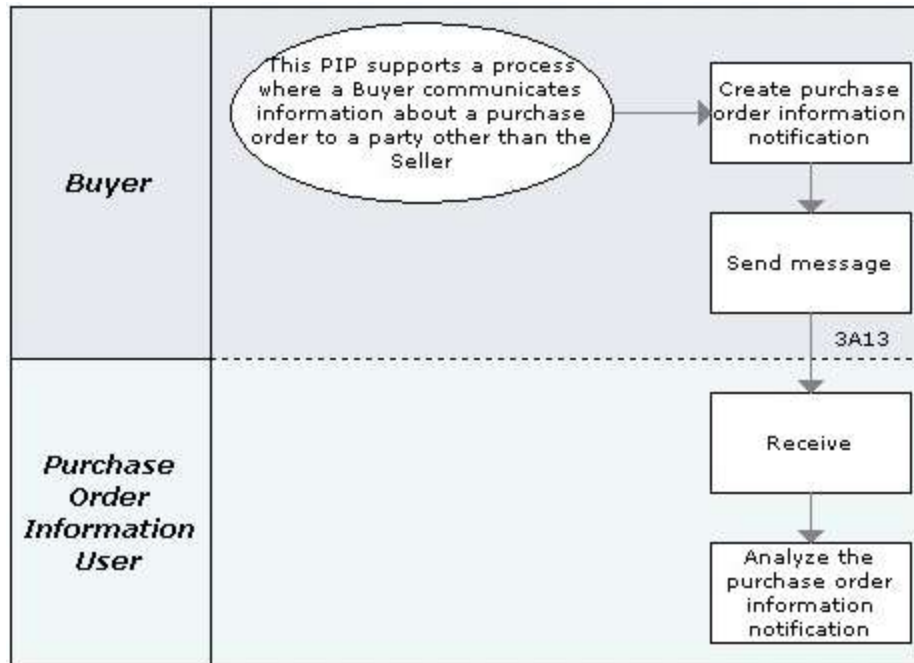

Note: RosettaNet Implementation Guides is available for PIP 3A13 version V01.00.00 (DTD).

6.1.12 PIP 3A14: Distribute Planned Order

DTD XML Schema

Purpose: To support a process where a Buyer communicates information to a party other than the Seller about purchase orders that are planned to be issued in the future. The Buyer is the owner or initiator of the purchase orders, the Seller is the recipient of the purchase orders and the third party receiving the information about the purchase orders is referred to as the Purchase Order Information User.

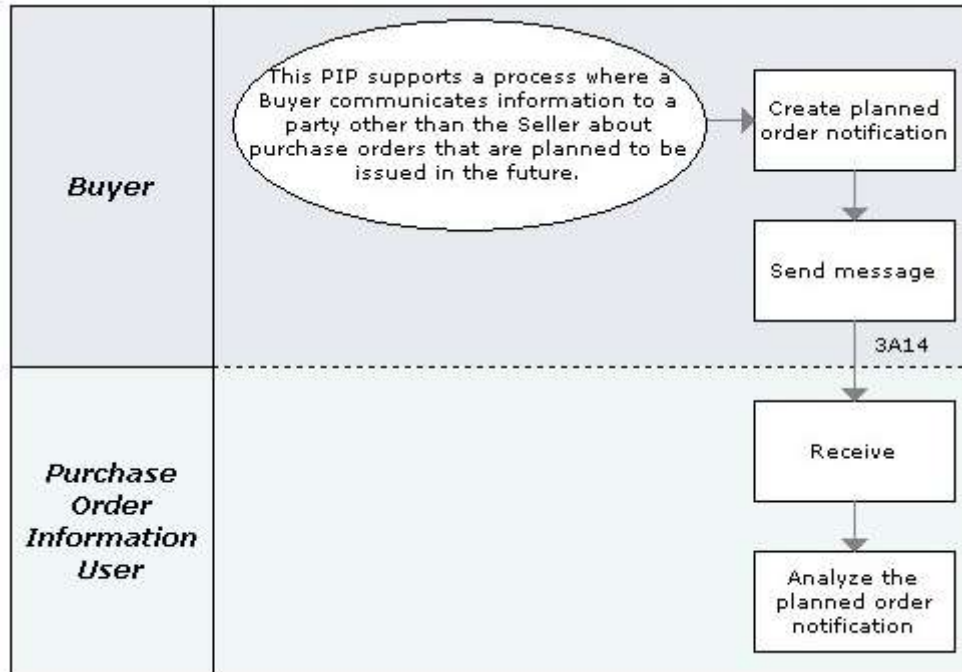

6.1.2 PIP 3A15: Notify of Quote Request

☒ DTD ☒ XML Schema

Purpose: This PIP provides a buyer with quotes and referrals used to select suppliers and prepare purchase orders.

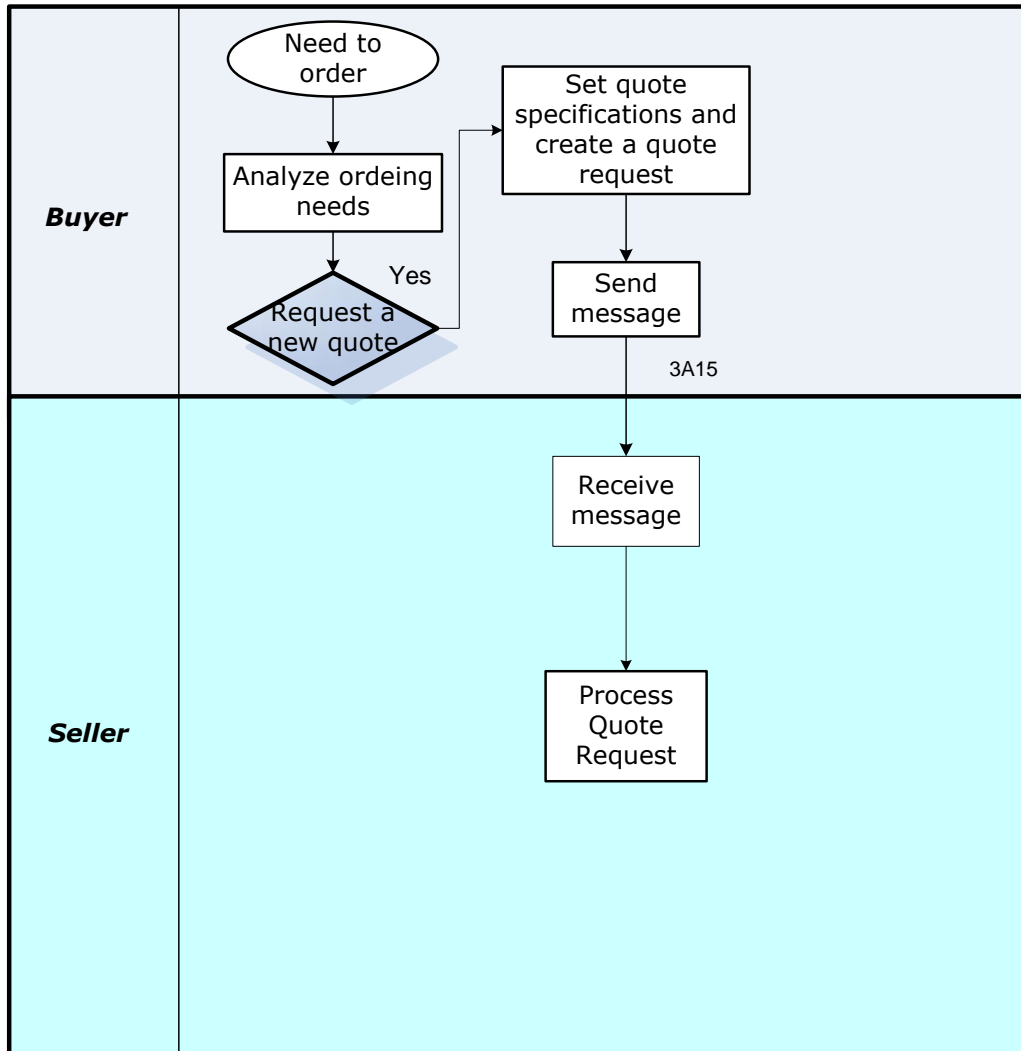

6.1.2 PIP 3A16: Notify of Quote Confirmation

☒ DTD ☒ XML Schema

Purpose: This PIP provides a buyer with quotes and referrals used to select suppliers and prepare purchase orders.

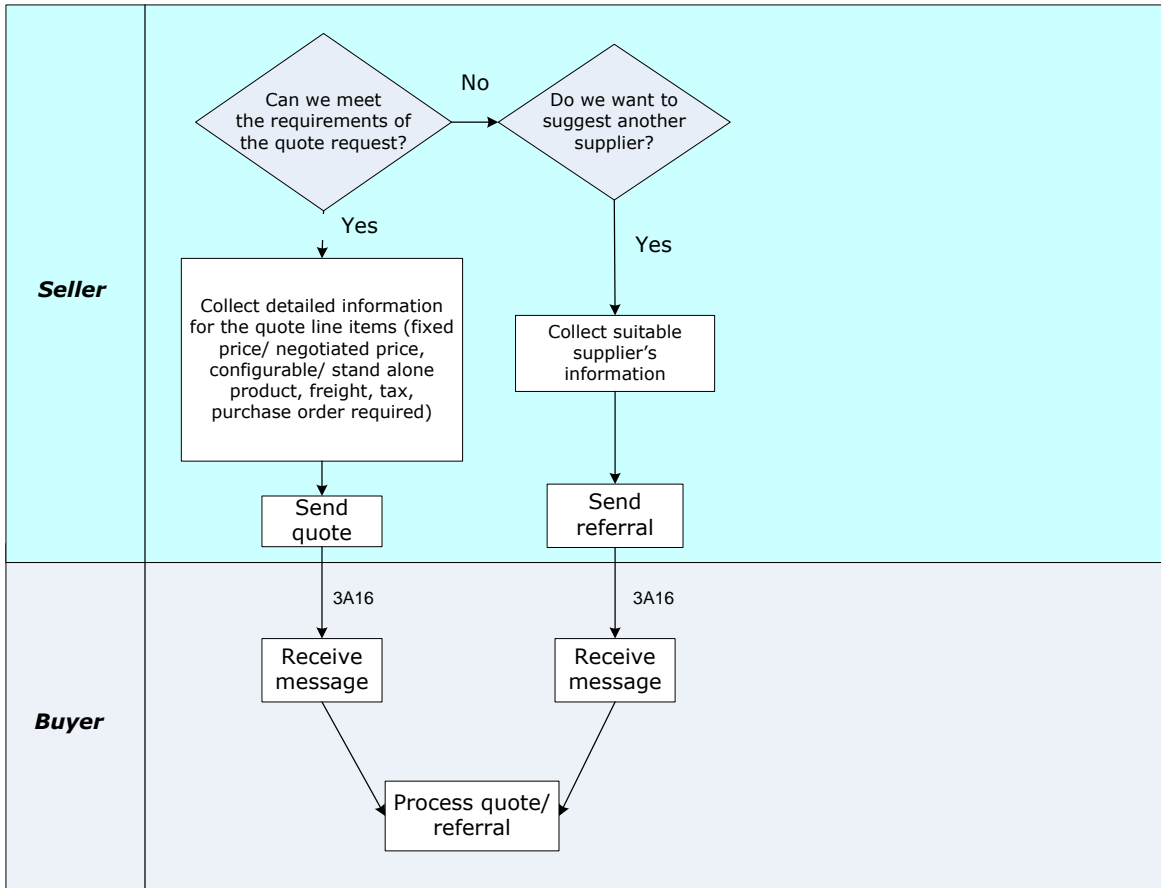

6.1.2 PIP 3A17: Distribute Price And Availability Request

☒ DTD ☒ XML Schema

Purpose: This PIP provides a customer with product price and availability information used to identify potential product suppliers.

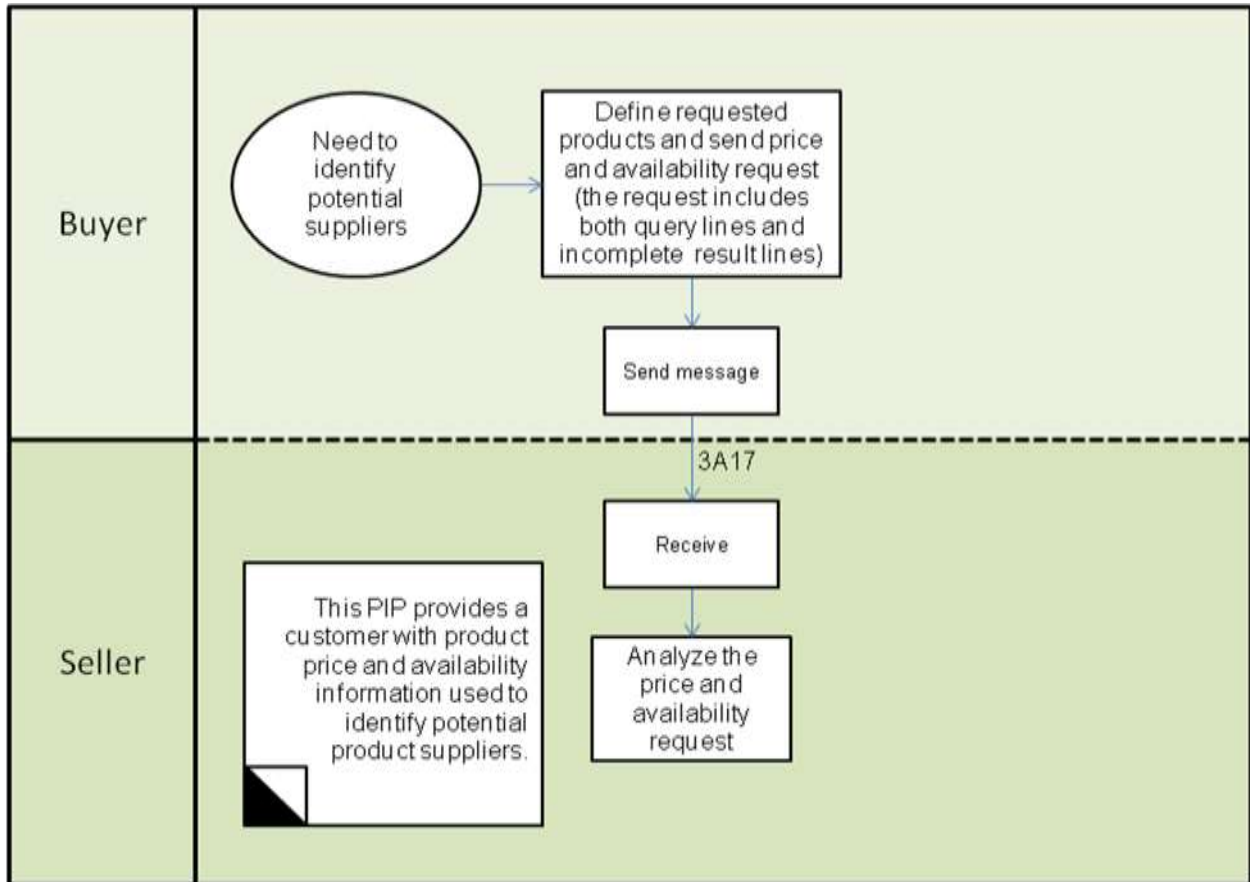

6.1.3 PIP 3A18: Distribute Price And Availability Response

☒ DTD ☒ XML Schema

Purpose: This PIP provides a buyer with product price and availability information used to identify potential suppliers.

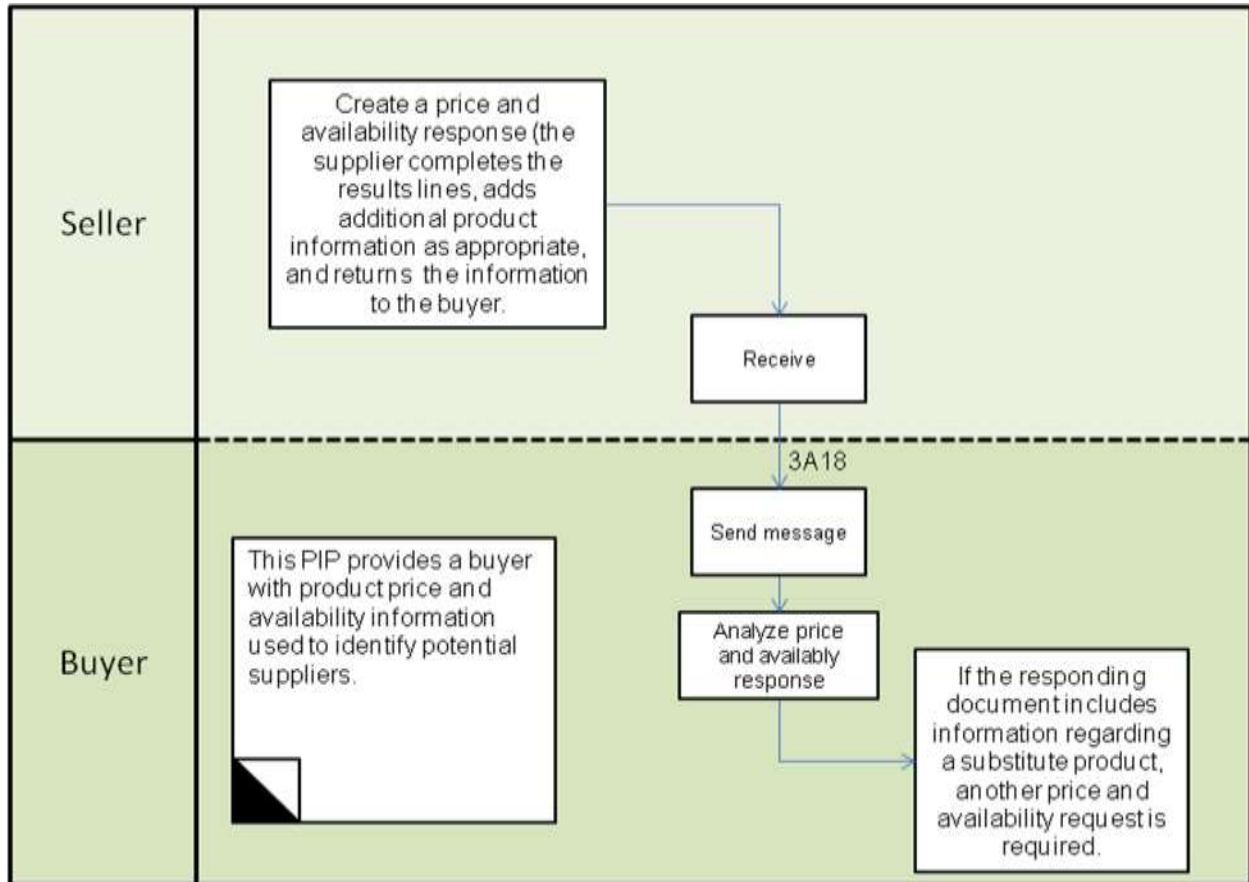

6.1.4 PIP 3A19: Notify of Purchase Order Request

DTD XML Schema

Purpose: This PIP enables a buyer to issue a purchase order.

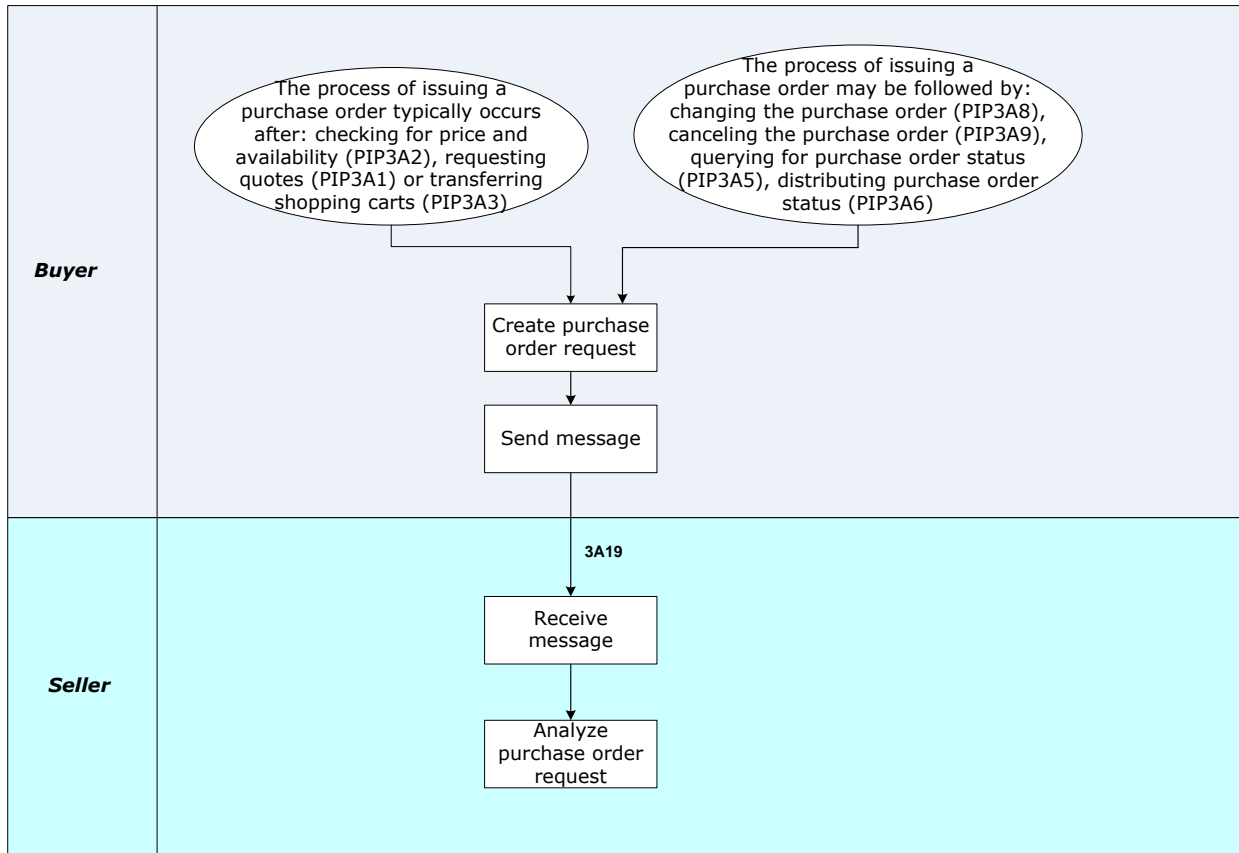

6.1.5 PIP 3A20: Notify of Purchase Order Confirmation

☒ DTD ☒ XML Schema

Purpose: This PIP enables a seller to issue a quick response to the buyer that acknowledges which of the purchase order product line items are accepted, rejected, or pending.

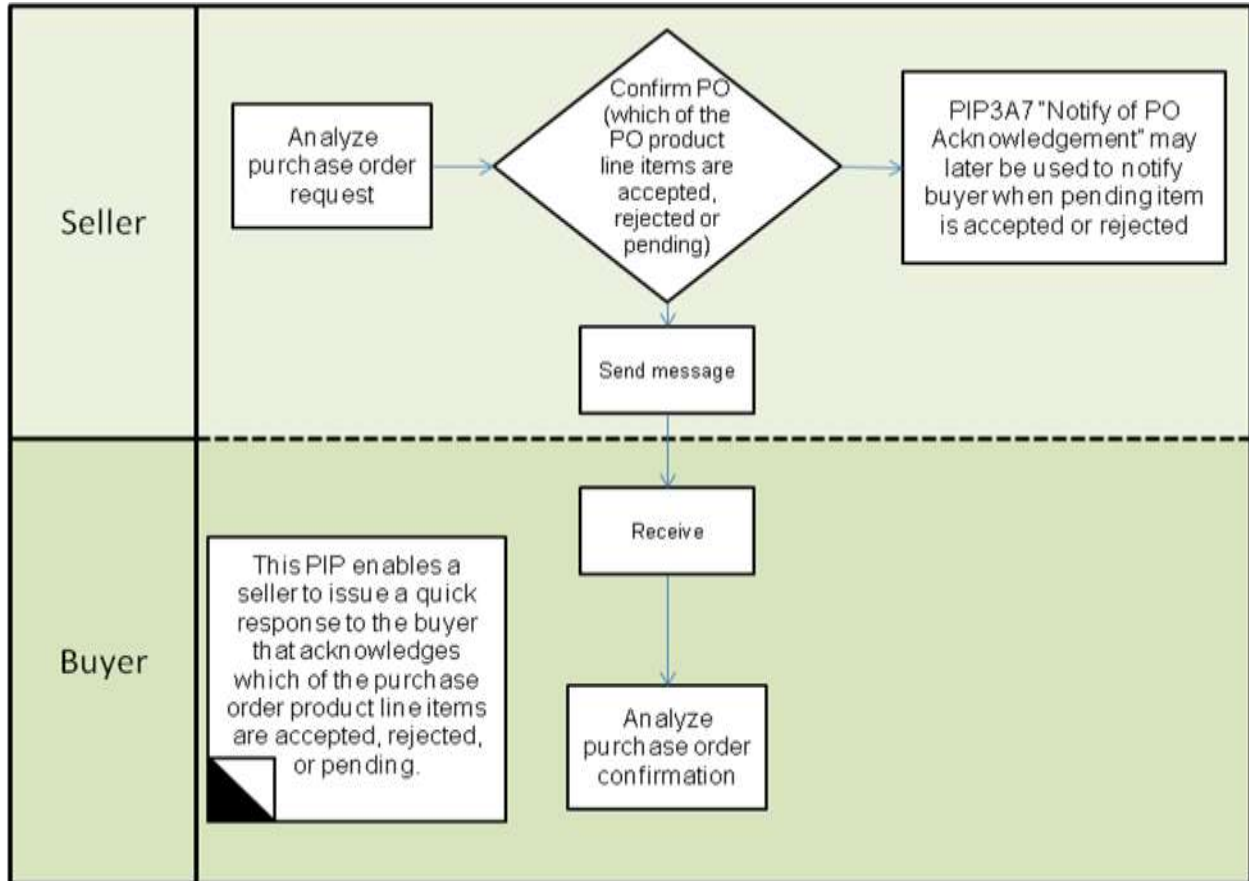

6.1.6 PIP 3A21: Notify of Purchase Order Change Request

☒ DTD ☒ XML Schema

Purpose: This PIP enables a buyer to change purchase order line items and obtain a quick response from the seller that acknowledges, at the line level, if the changes are accepted, rejected, or pending.

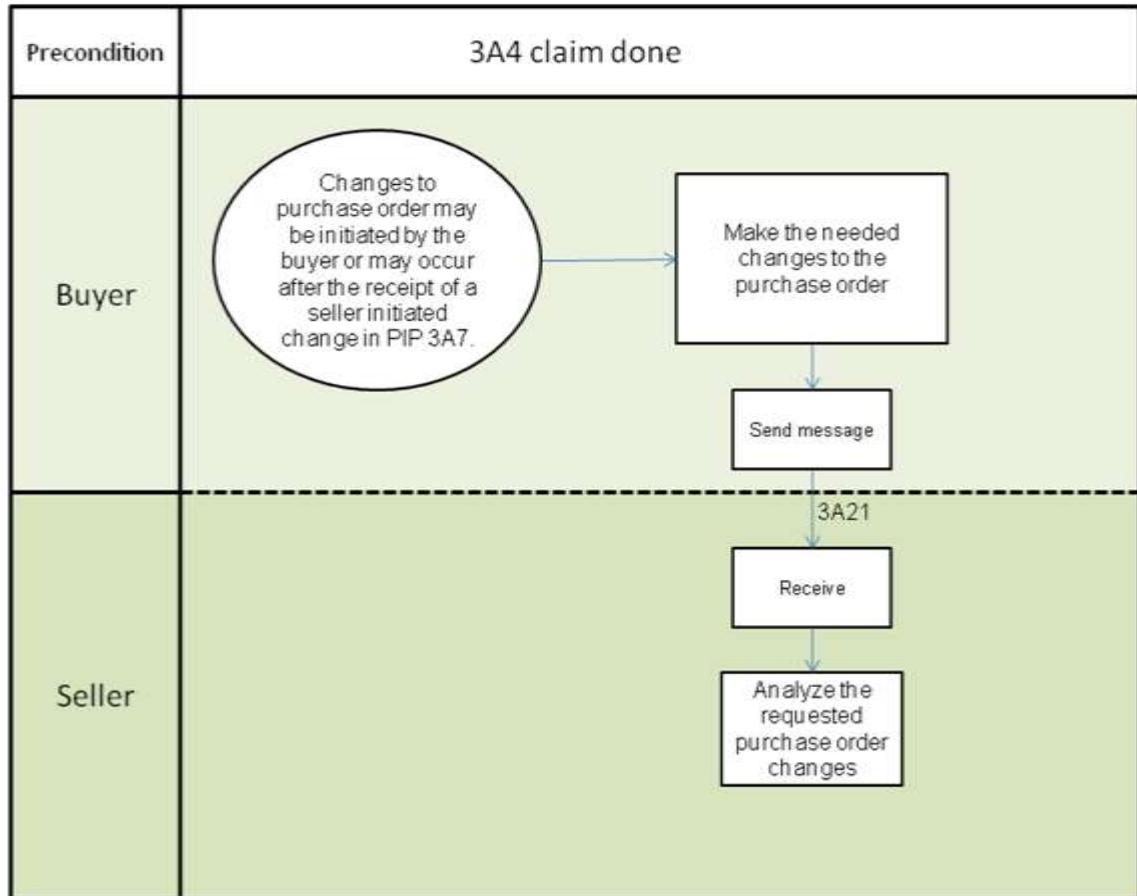

6.1.7 PIP 3A22: Notify of Purchase Order Change Confirmation

☒ DTD ☒ XML Schema

Purpose: This PIP enables a seller to acknowledge change to purchase order line items made by the buyer, at the line level. Changes can be accepted, rejected, or set to pending.

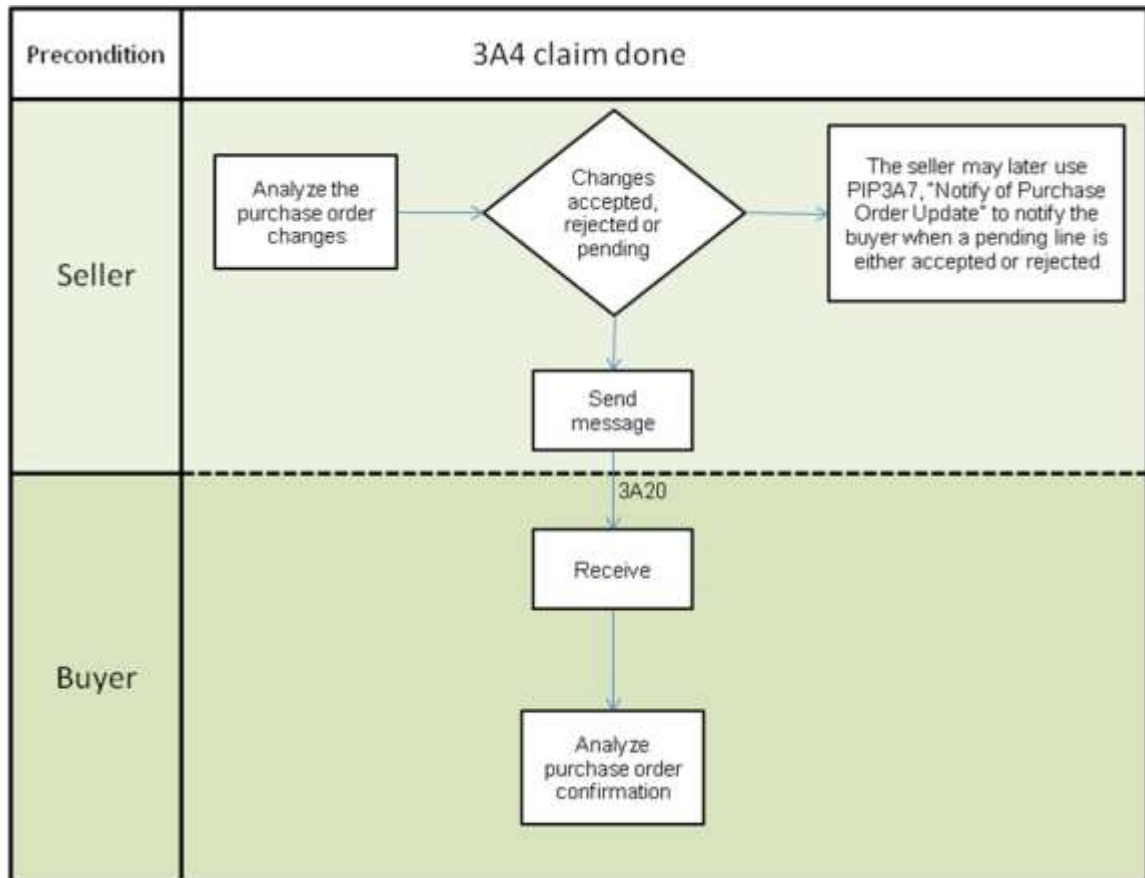

6.1.8 PIP 3A23: Notify of Purchase Order Cancellation Request

DTD XML Schema

Purpose: s PIP enables a buyer to cancel a purchase order.

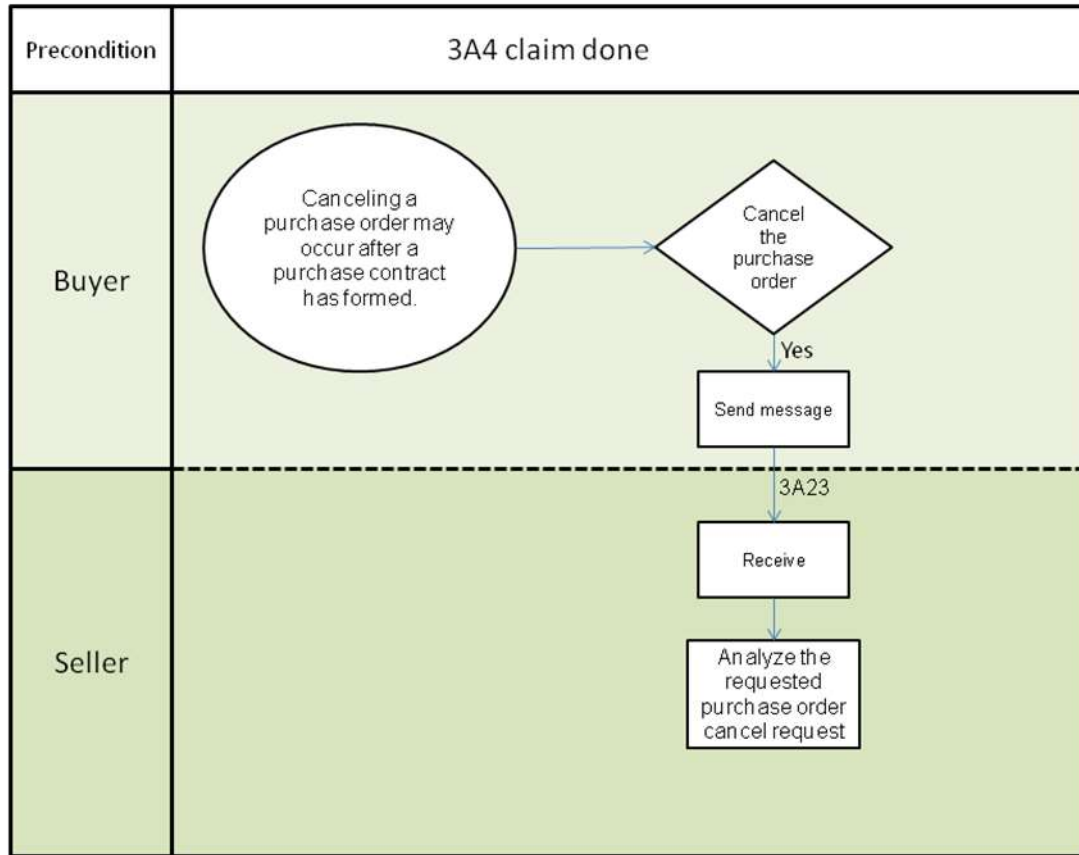

6.1.9 PIP 3A24: Notify of Purchase Order Cancellation Confirmation

☒ DTD ☒ XML Schema

Purpose: This PIP enables a seller to respond to a purchase order cancellation and to confirm if the cancellation is accepted or rejected.

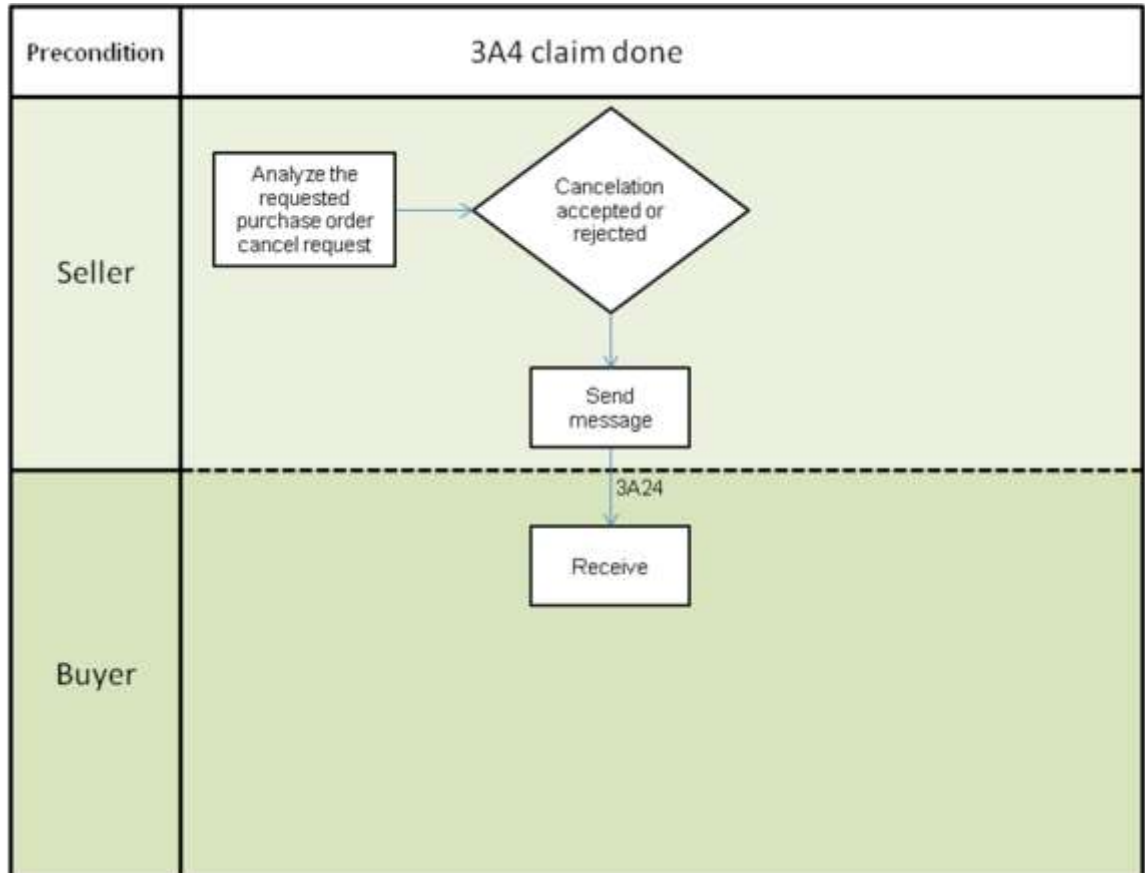

6.2 Segment 3B: Transportation and Distribution

This segment enables communication of shipping- and delivery-related information with the ability to make changes and handle exceptions and claims.

6.2.1 PIP 3B1: Distribute Transportation Projection

DTD XML Schema

Purpose: For a Shipment Requester to notify a Transport Service Provider of the shipments that are currently booked, as a notification requiring no response. Transport Service Providers can use this PIP to perform day-to-day management of the shipment space for the "usual" volume or for the exceptions or remote shipments that require special handling. The Transportation Projection Notification contains aggregate shipment data.

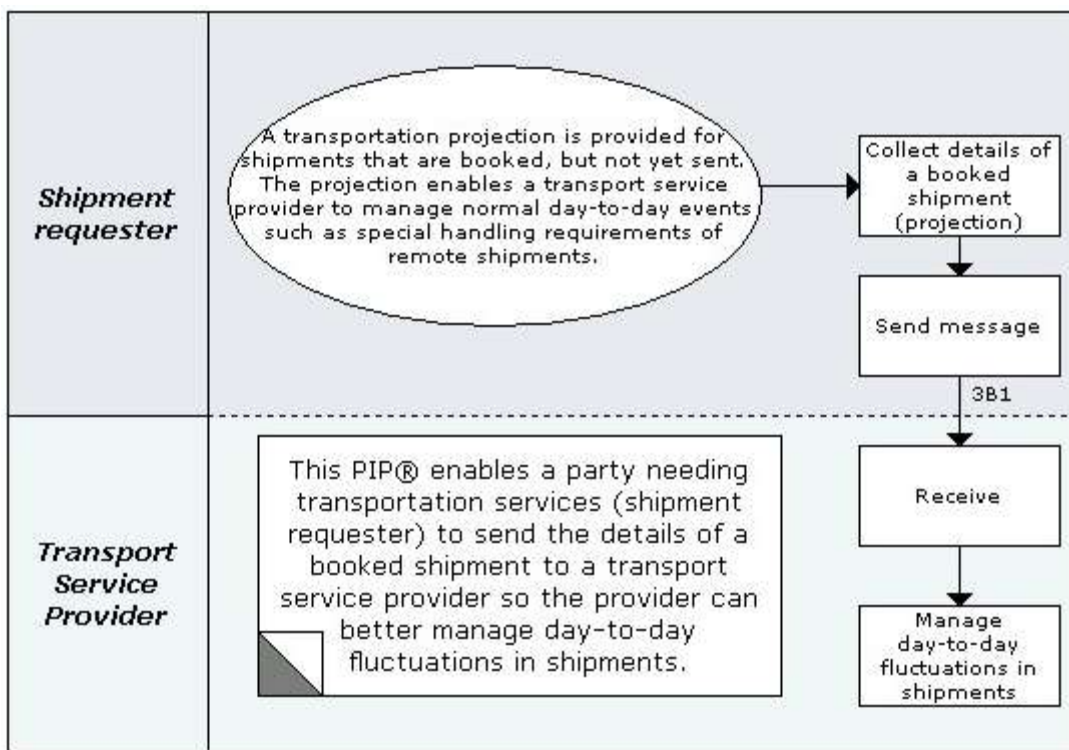

6.2.2 PIP 3B2: Notify of Advance Shipment

DTD XML Schema

Purpose: This allows a Shipper to notify a Receiver that a shipment has been assigned. The purpose of the Advance Shipment Notification is to communicate at the detailed product level the contents of a shipment, when the shipment is expected to arrive, and other shipment information.

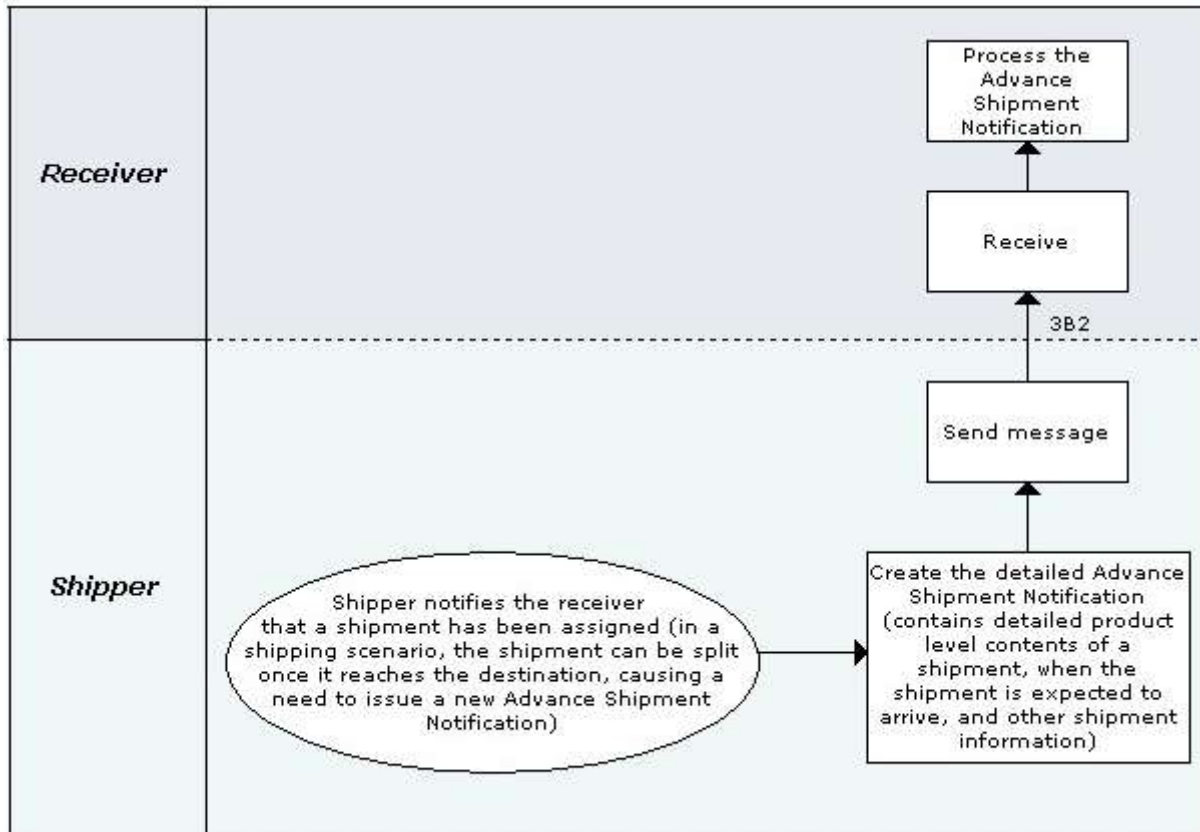

Note: RosettaNet Implementation Guides is available for PIP 3B2 version V01.01.00 (DTD).

6.2.3 PIP 3B3: Distribute Shipment Status

☒ DTD ☒ XML Schema

Purpose: This enables a Transport Service Provider to report status (via a Shipment Status Notification) of a shipment while the shipment is being transported to the end consignee, or gateway (where the shipment is tendered to another Transport Service Provider). Once a shipment has reached the consignee, this PIP can be used to notify of shipment delivery exceptions.

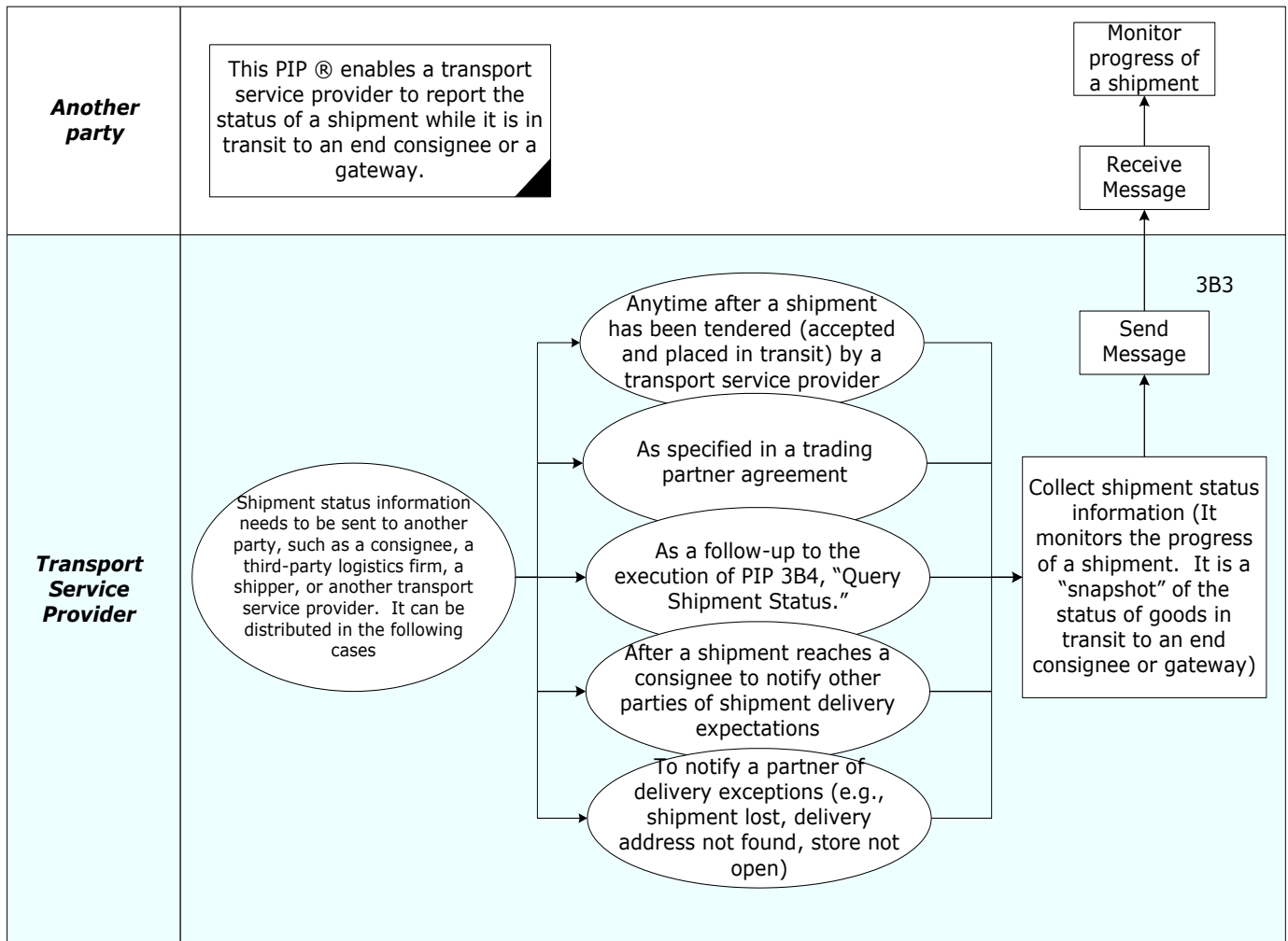

6.2.4 PIP 3B4: Query Shipment Status

DTD XML Schema

Purpose: This provides for an In-transit Information User to query status on a shipment, and for the Transport Service Provider to respond with a Shipment Status Notification.

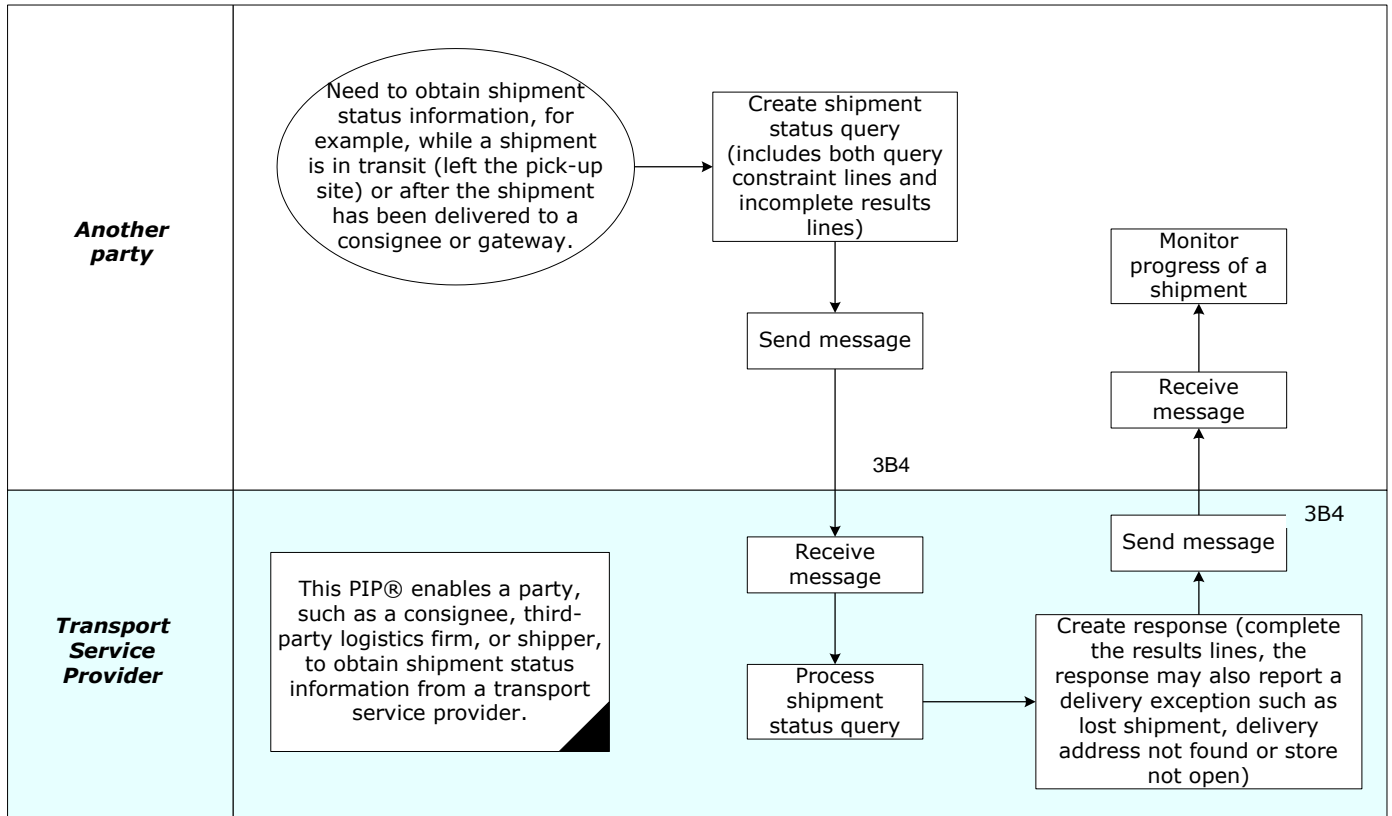

6.2.5 PIP 3B5: Request Shipment Change

DTD XML Schema

Purpose: This provides the capability for Shipment Controller (party who can change or redirect a shipment) to change a shipment while the shipment is being transported to the end-consignee or gateway.

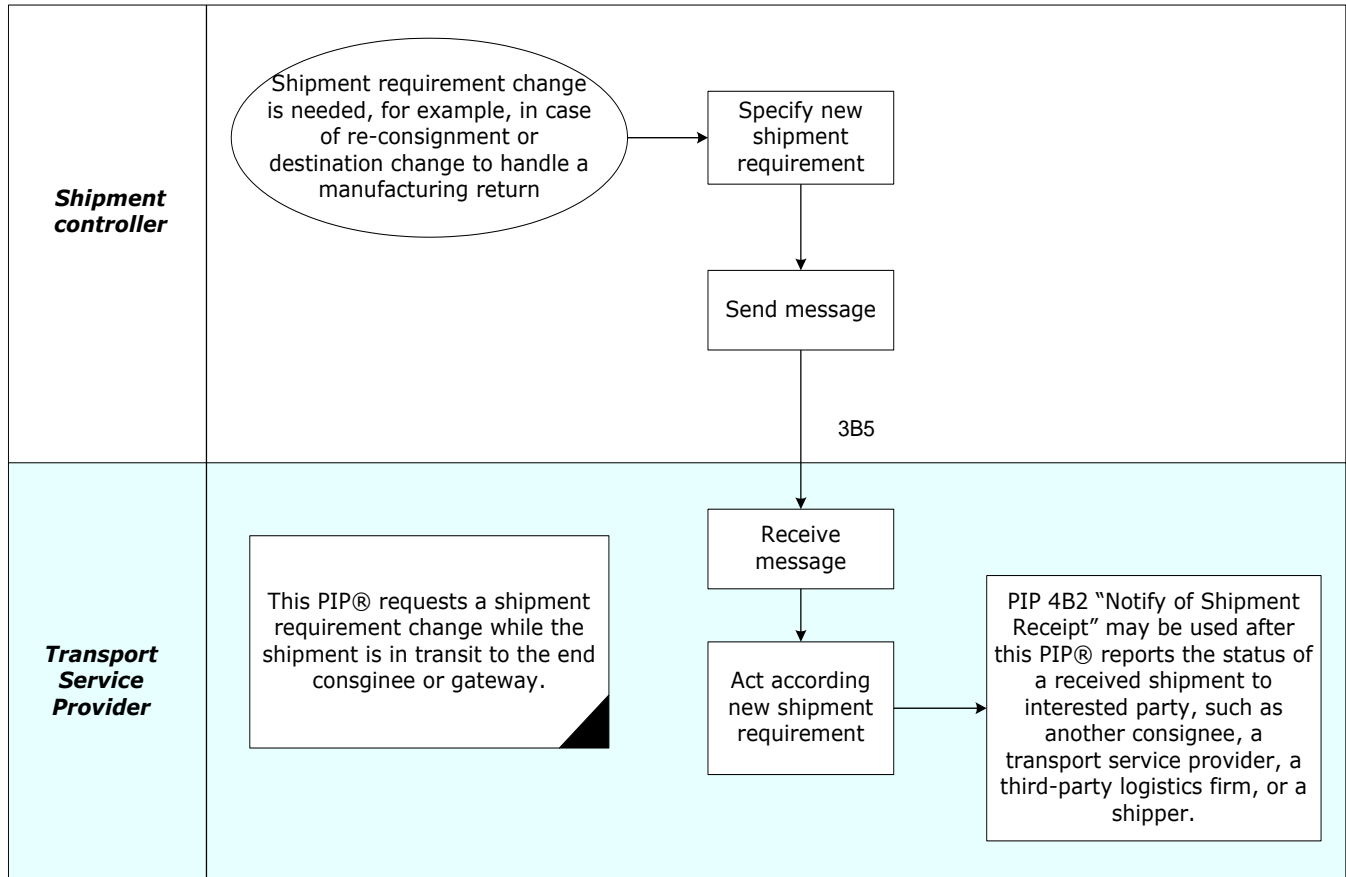

6.2.6 PIP 3B6: Notify of Shipments Tendered

DTD XML Schema

Purpose: This enables a shipper to send a manifest to another party. A manifest confirms that a shipment has been tendered to a transport service provider and includes pallet and carton information.

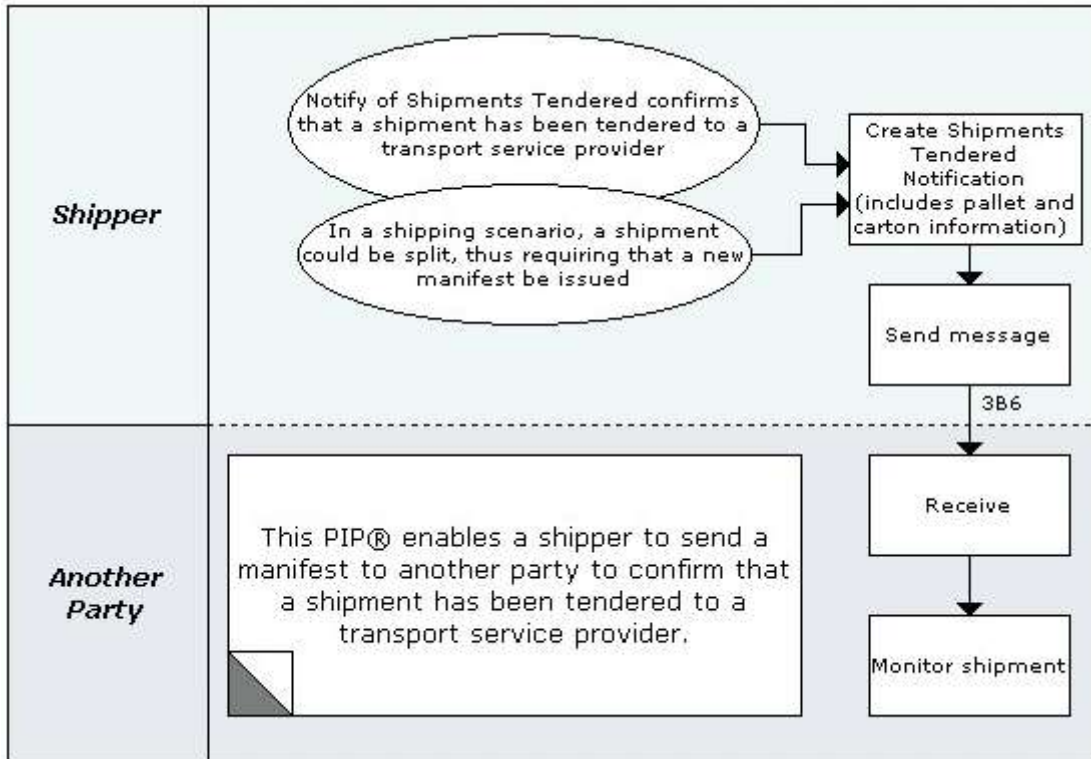

6.2.7 PIP 3B11: Notify of Shipping Order

DTD XML Schema

Purpose: This enables the Inventory Owner to issue a shipping authorization to the Logistics Service Provider to ship inventory against another document, e.g., sales order, scrap order, replacement order, demo or sample order. Shipping Order becomes a traceable document for audit purposes. Inventory detail is specified according to the TPA terms of engagement between the Logistics Provider and it's client.

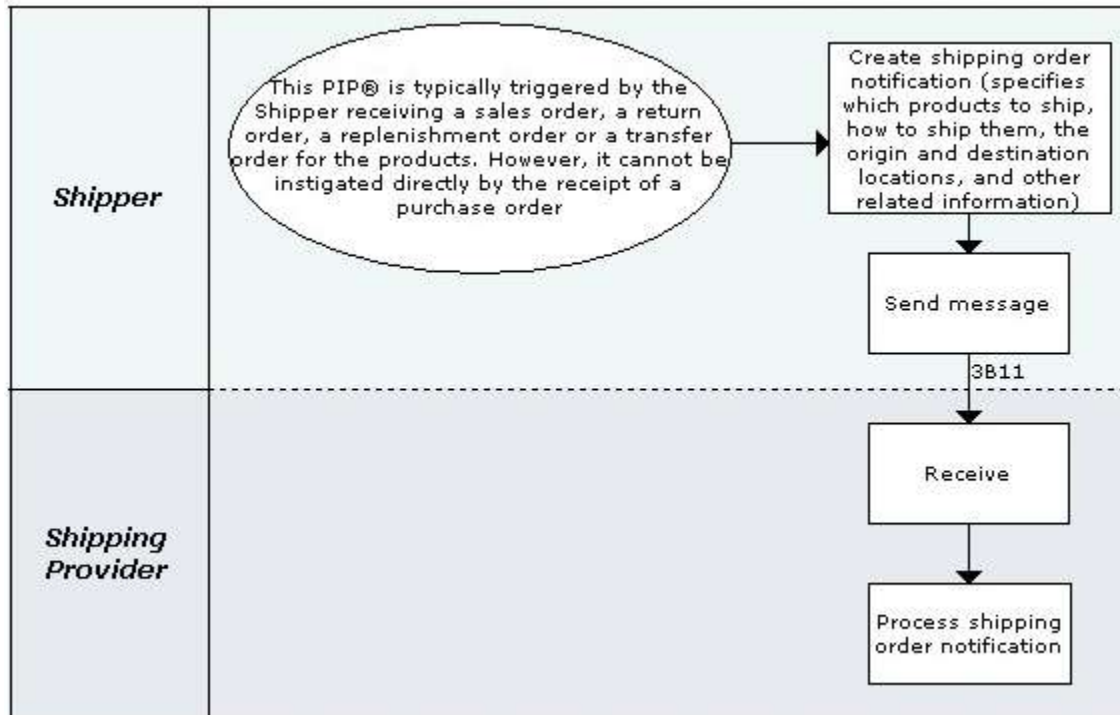

6.2.8 PIP 3B12: Request Shipping Order

☒ DTD ☒ XML Schema

Purpose: This supports a process between in which a Shipper authorizes a Shipping Provider to ship products from one location to another. The Shipper is the organization responsible for the supply of products to its customers. The Shipping Provider is a third-party that performs the shipping logistics on behalf of the Shipper. This physical movement of products may involve the seller which initiates the shipping of the products, the buyer as the consignee to which the products are shipped and additionally, there may be third-party logistics (3PL) and even fourth-party logistics (4PL) providers, offering services to the shipper such as outsourced light manufacturing, product warehousing, routing and tracking, in addition to physically transporting the products.

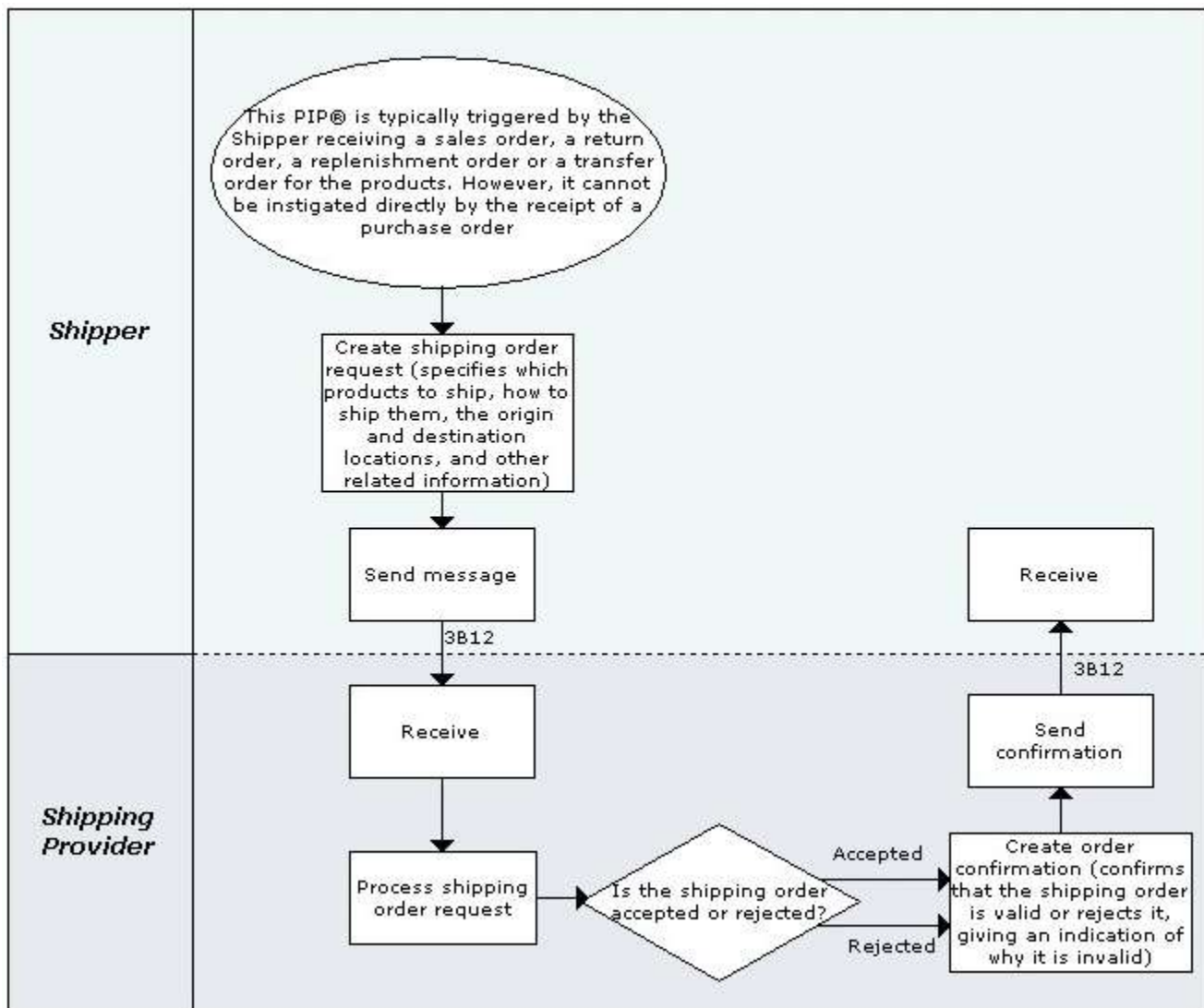

Note: RosettaNet Implementation Guides is available for PIP 3B12 version V01.00.00 (DTD), version V01.01.00 (DTD), and version V11.01.00 (XML Schema).

6.2.9 PIP 3B13: Notify of Shipping Order Confirmation

DTD XML Schema

Purpose: This enables a third-party logistics provider to confirm that a requested shipment has been sent on behalf of a manufacturer or distributor that uses outsourced logistics operations.

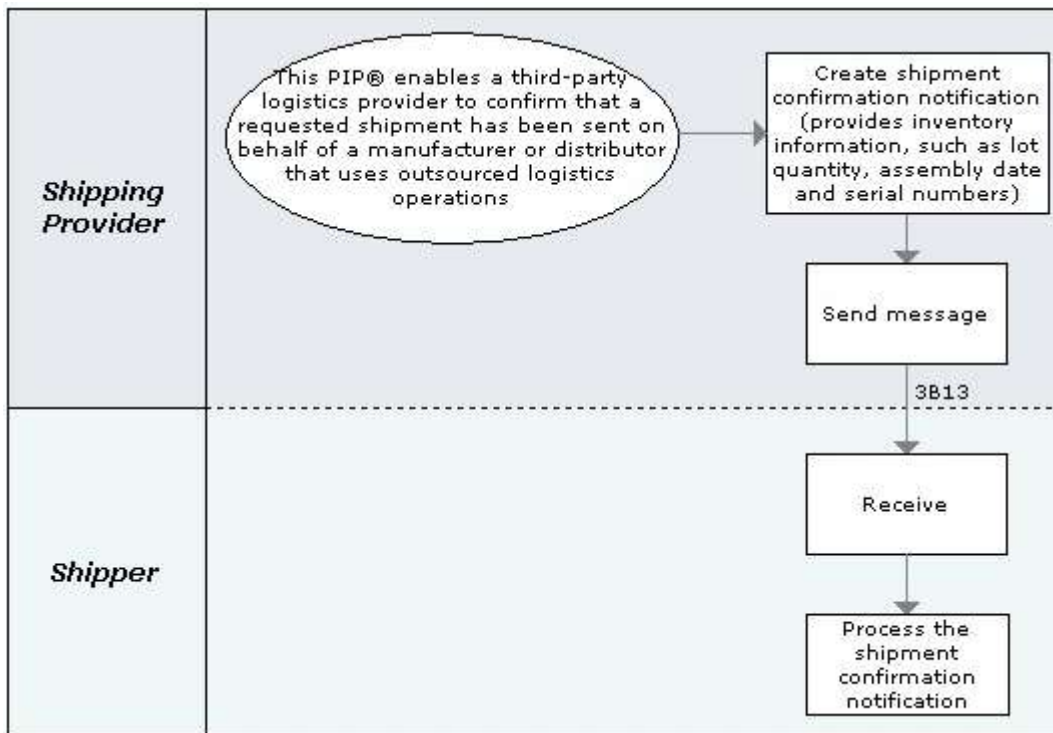

Note: RosettaNet Implementation Guides is available for PIP 3B13 version V01.00.00 (DTD) and version V01.01.00 (DTD).

6.2.10 PIP 3B14: Request Shipping Order Cancellation

☒ DTD ☒ XML Schema

Purpose: This supports a process between two of these parties (seller, buyer, 3PL or 4PL), in which a Shipper cancels a shipping order that has been sent previously to a Shipping Provider. The Shipper is the organization responsible for the supply of products to its customers, i.e. the first party described above. The Shipping Provider is a third-party that performs the shipping logistics on behalf of the Shipper.

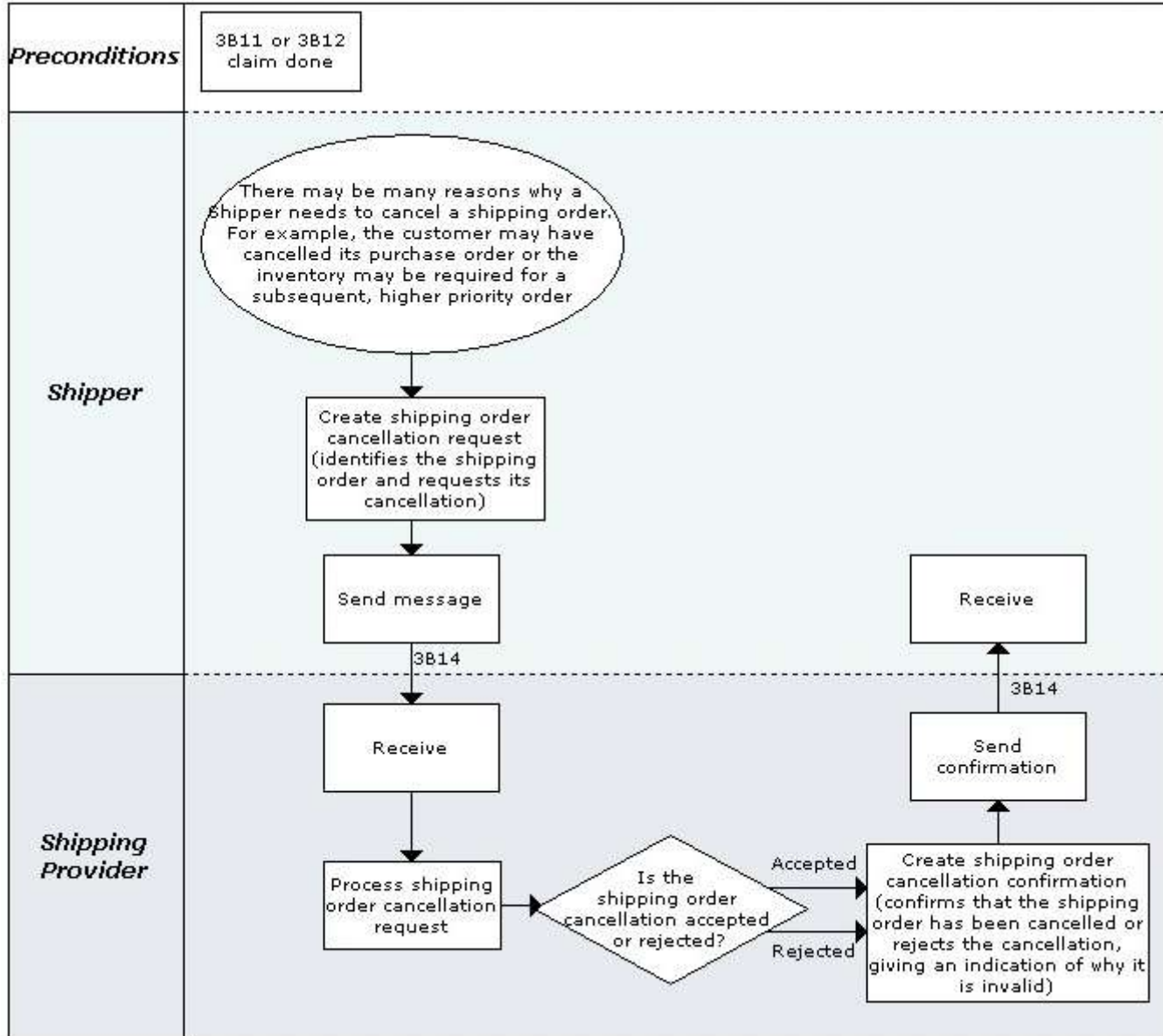

Note: RosettaNet Implementation Guides is available for PIP 3B14 version V01.00.00 (DTD) and version V11.10.00 (XML Schema).

6.2.11 PIP 3B18: Notify of Shipment Documentation

DTD XML Schema

Purpose: This supports a process in which a Shipper communicates information that a Shipping Provider must incorporate in the documentation to accompany a shipment. The Shipper is the organization responsible for the supply of products to its customers. The Shipping Provider is a third-party that performs the shipping logistics on behalf of the Shipper.

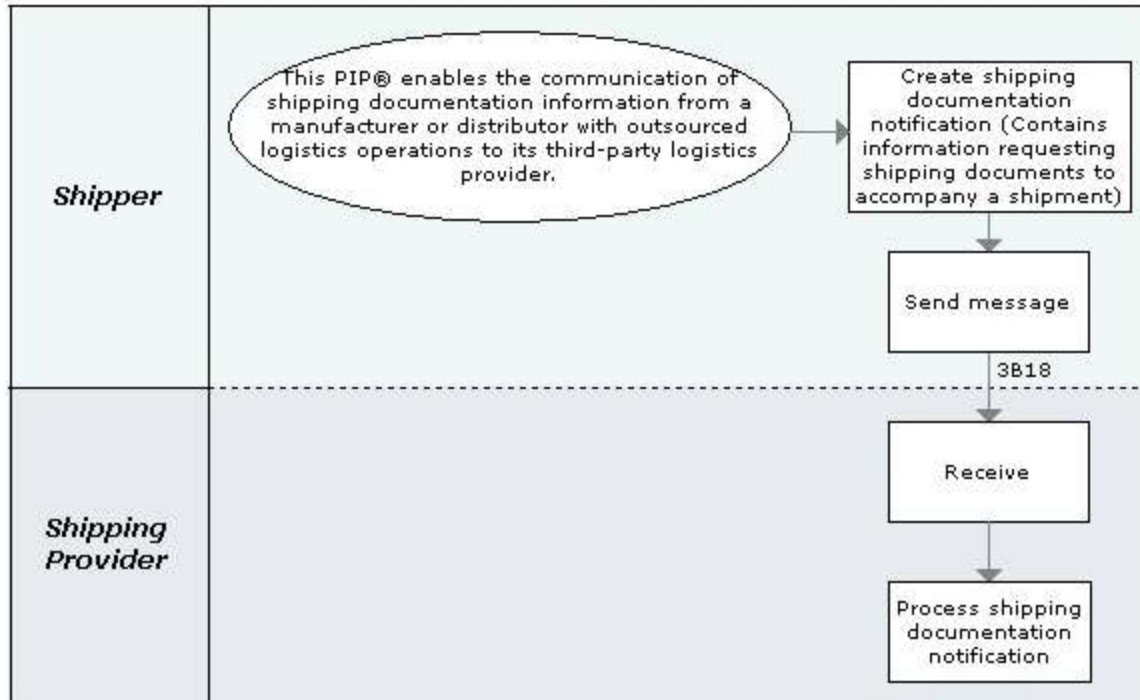

Note: RosettaNet Implementation Guides is available for PIP 3B18 version V01.00.00 (DTD) and version V11.00.00 (XML Schema).

6.2.12 PIP 3B19: Notify of Shipping Order Request

DTD XML Schema

Purpose: This PIP is designed to enable the communication of shipping orders from a manufacturer or distributor with outsourced logistics operations to its third-party logistics provider.

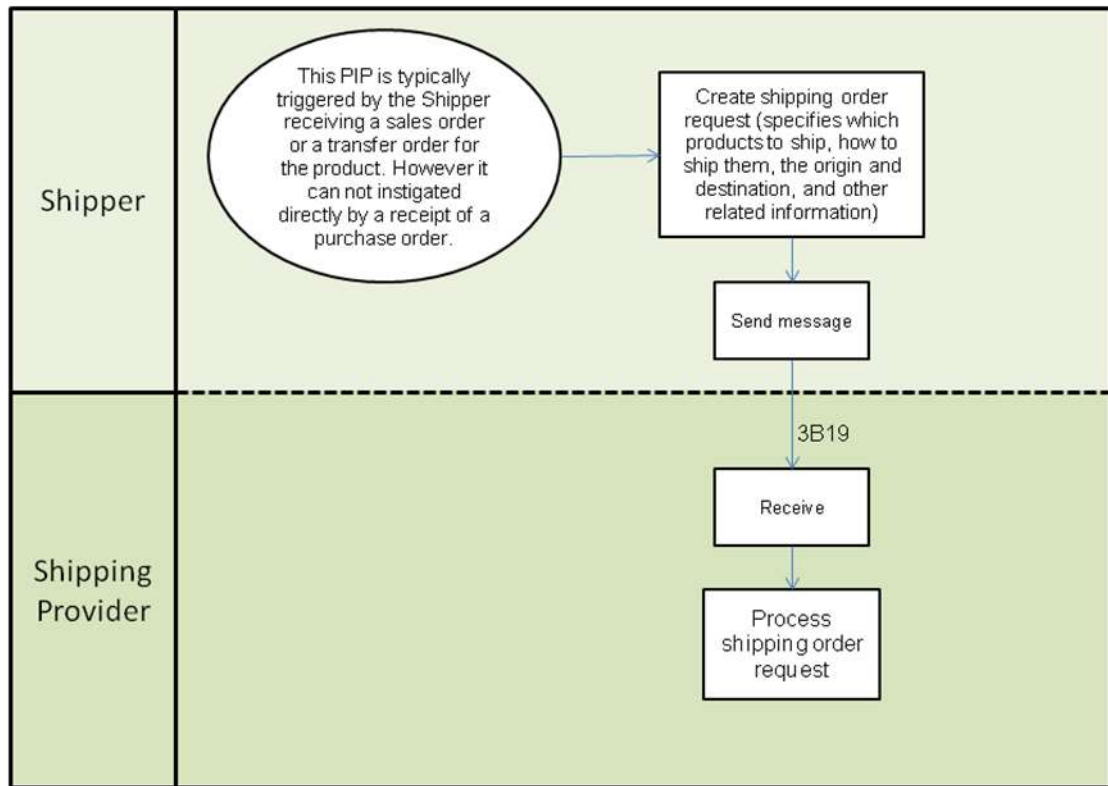

6.2.13 PIP 3B20: Notify of Shipping Order Confirmation

DTD XML Schema

Purpose: This PIP is designed to the Shipping Provider to respond to a Shipping Order Request with a Shipping Order Confirmation.

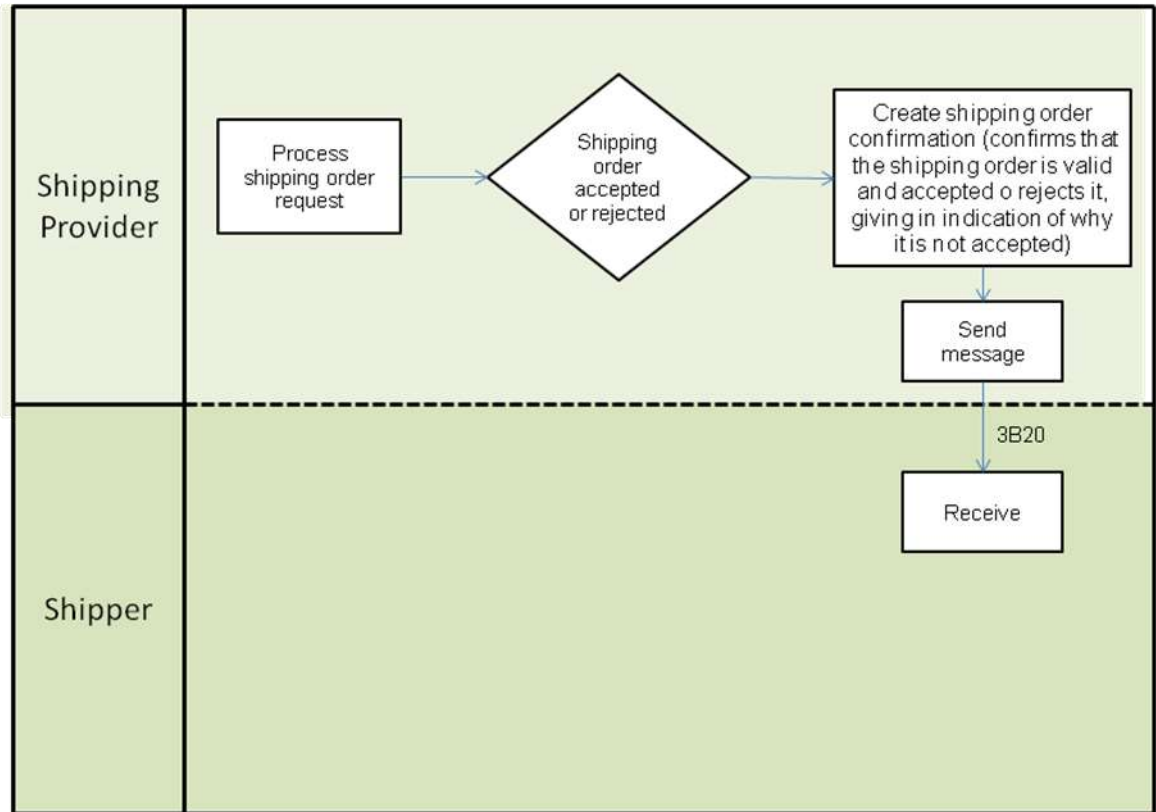

6.2.14 PIP 3B21: Notify of Shipping Order Cancellation Request

☒ DTD ☒ XML Schema

Purpose: This PIP is designed to request the cancellation of previously placed shipping orders. A shipping order is an instruction from a manufacturer or distributor with outsourced logistics operations to its third-party logistics provider.

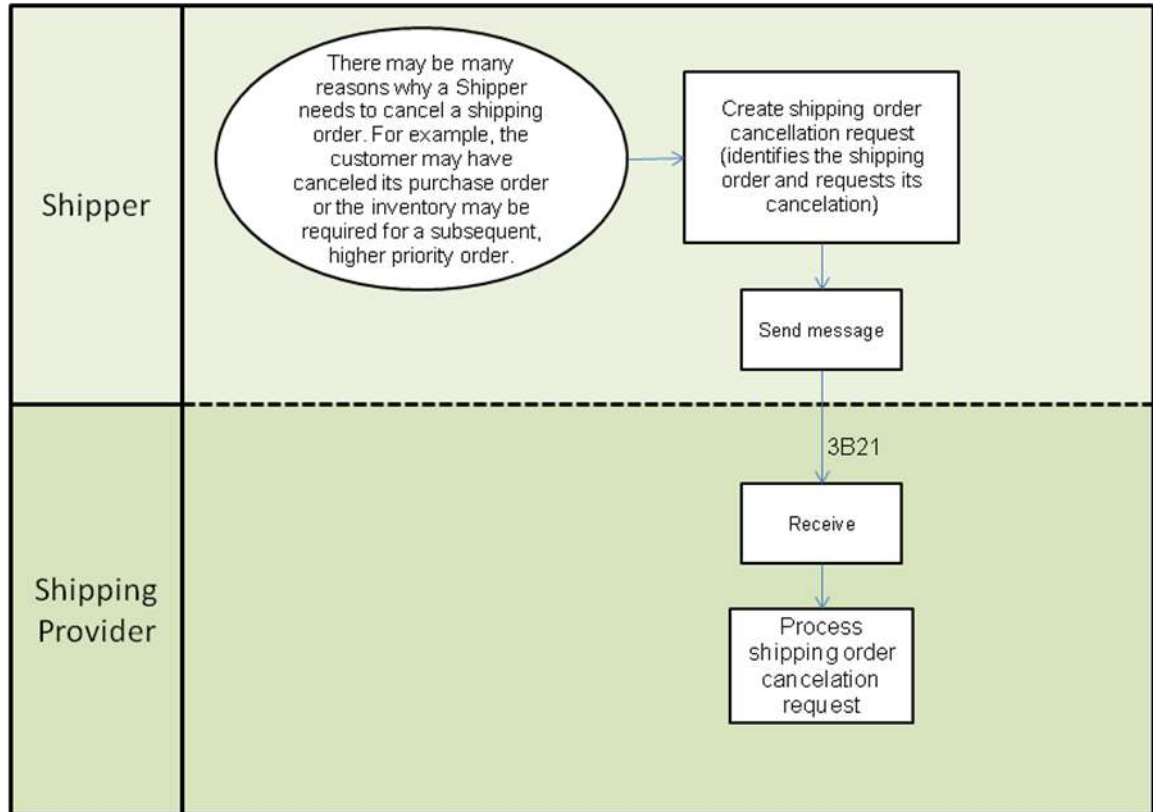

6.2.15 PIP 3B22: Notify of Shipping Order Cancellation Confirmation

☒ DTD ☒ XML Schema

Purpose: This PIP is designed to confirm the cancellation of previously placed shipping orders. A shipping order is an instruction from a manufacturer or distributor with outsourced logistics operations to its third-party logistics provider.

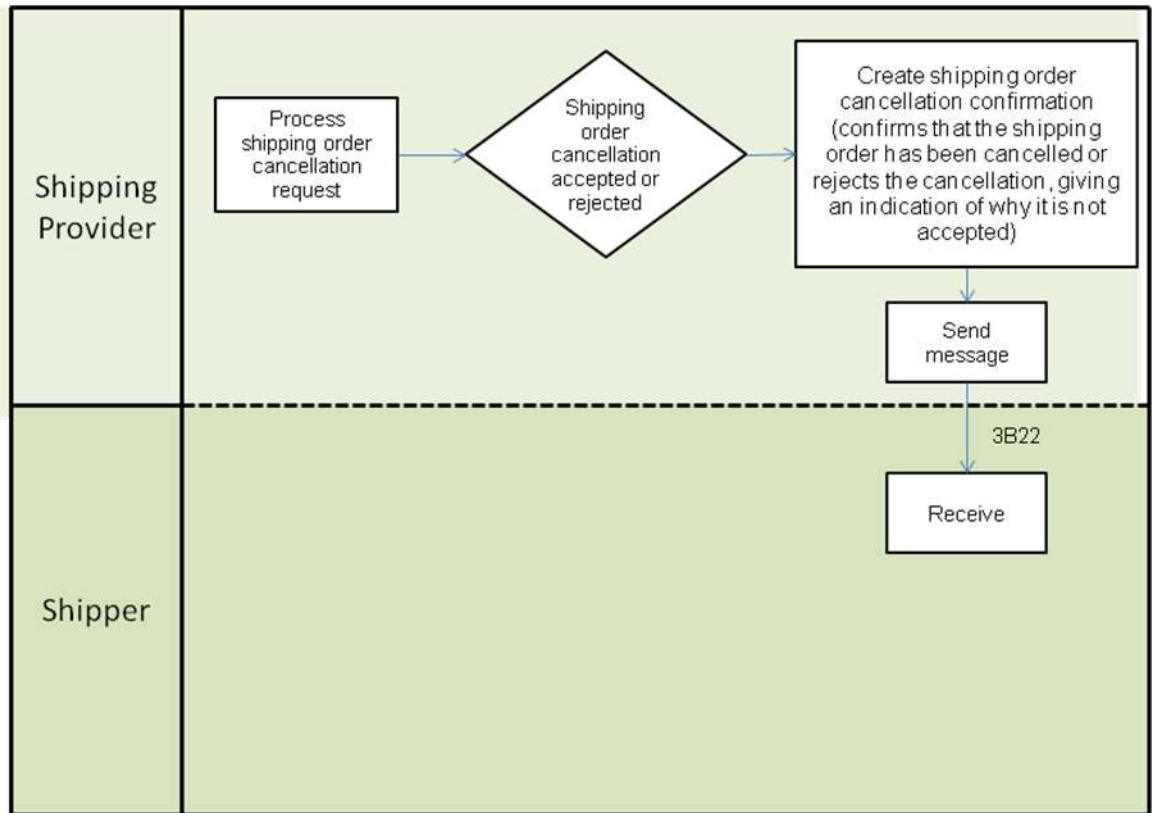

6.3 Segment 3C: Returns and Finance

This segment provides for issuance of billing, payment and reconciliation of debits, credits and invoices between partners as well as supports product return and its financial impact.

6.3.1 PIP 3C1: Return Product

- DTD
- XML Schema

Purpose: This enables a party (Return Requester) to submit a request to return a product to a Return Provider. The Return Provider either authorizes the return by issuing a Return Product Response. If the return is authorized, the Return Requester can ship the product to a location confirmed in the message exchange.

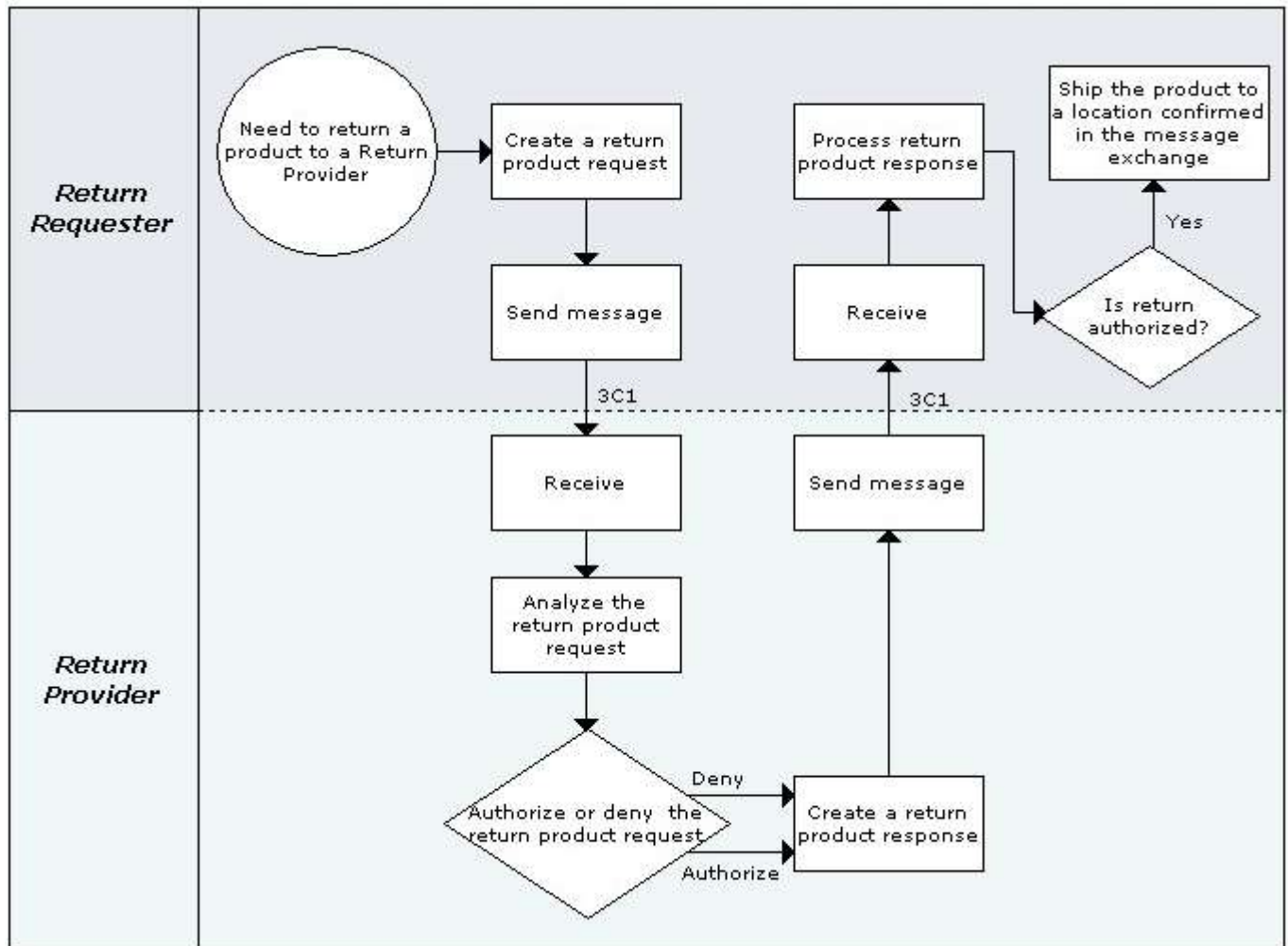

6.3.2 PIP 3C2: Request Financing Approval

DTD XML Schema

Purpose: To provide the capability to request and obtain a response on external financing for an order. The Seller requests financing approval on behalf of the Buyer. In the event the financing request was not approved, the Seller may handle this rejection by changing the order, attempting to increase the Buyer's credit line, or pursue other options outside of this PIP. This PIP can also be used to perform a "reversal", which is a retraction of a financing request.

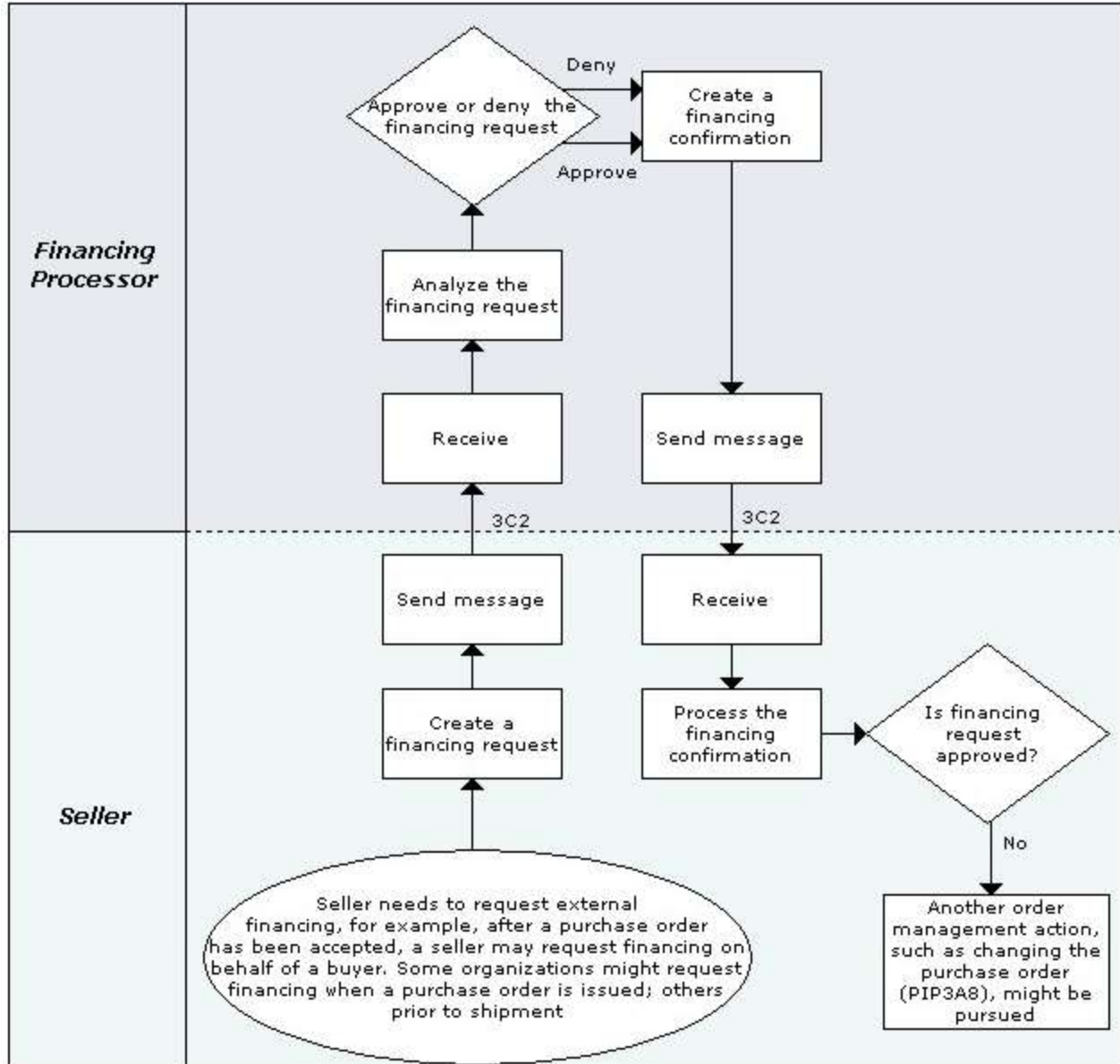

6.3.3 PIP 3C3: Notify of Invoice

☒ DTD ☒ XML Schema

Purpose: This enables an Invoice Provider, who is usually a seller, to issue an Invoice Notification; and for the Invoice Receiver, who is usually a buyer or a financing processor, to receive and validate the invoice. The financing processor can also re-issue the invoice to the buyer.

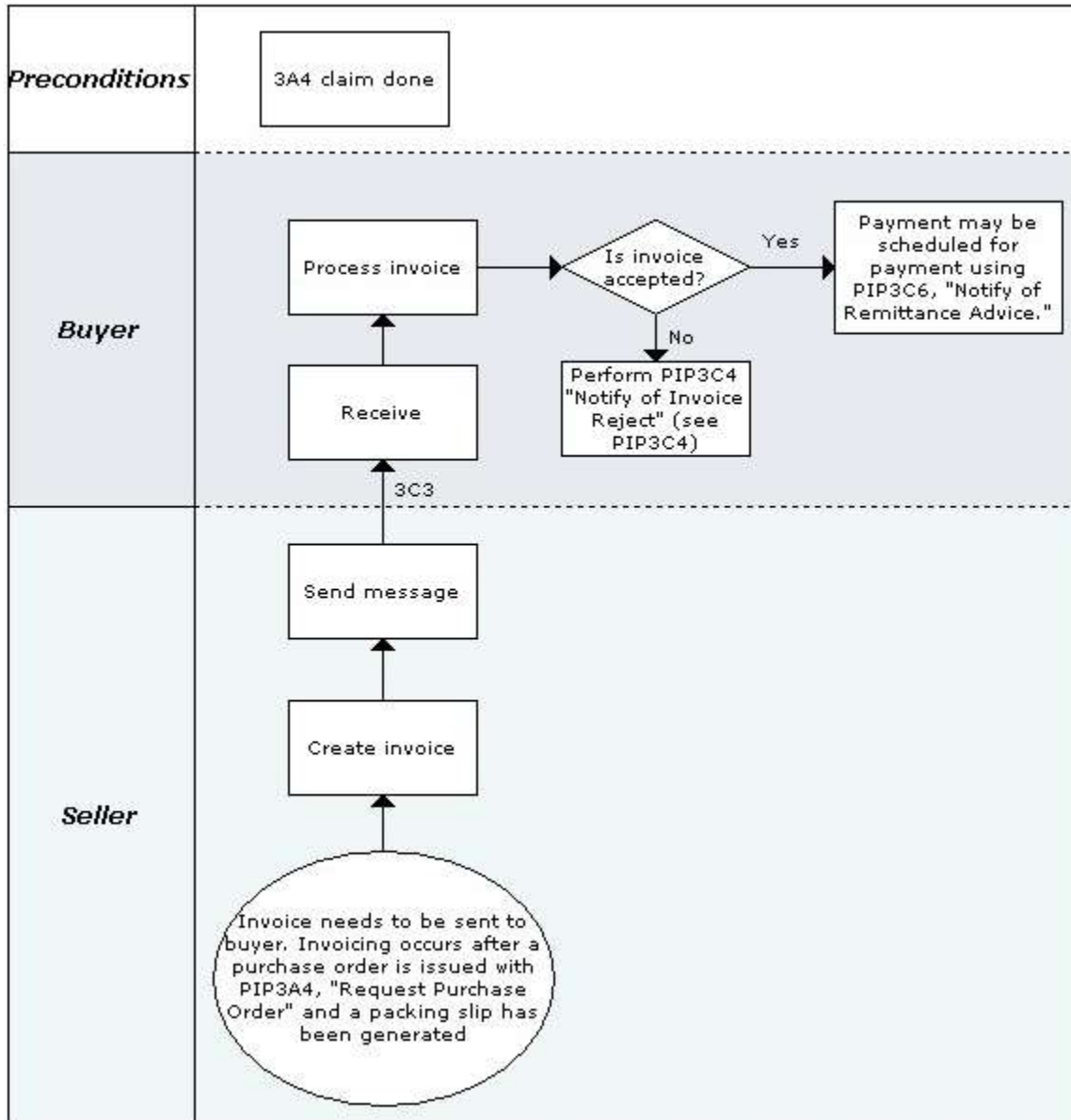

Note: RosettaNet Implementation Guides is available for PIP 3C3 version V01.01.00 (DTD).

6.3.4 PIP 3C4: Notify of Invoice Reject

DTD XML Schema

Purpose: To support a process by which payees issue financial statements to payors; payors determine which payables to pay, optionally using the financial statement notification, and generate remittance advice notifications, which go to their banks; payors' banks make payments to payees' banks, who send payments to payees; payees process payments and use the remittance advice notification to reconcile payments or issue payment discrepancy notifications in the event payments are not as expected; if payment discrepancy notifications are generated, payors process payment discrepancy notifications and determine whether to reissue payments by remittance advice notifications.

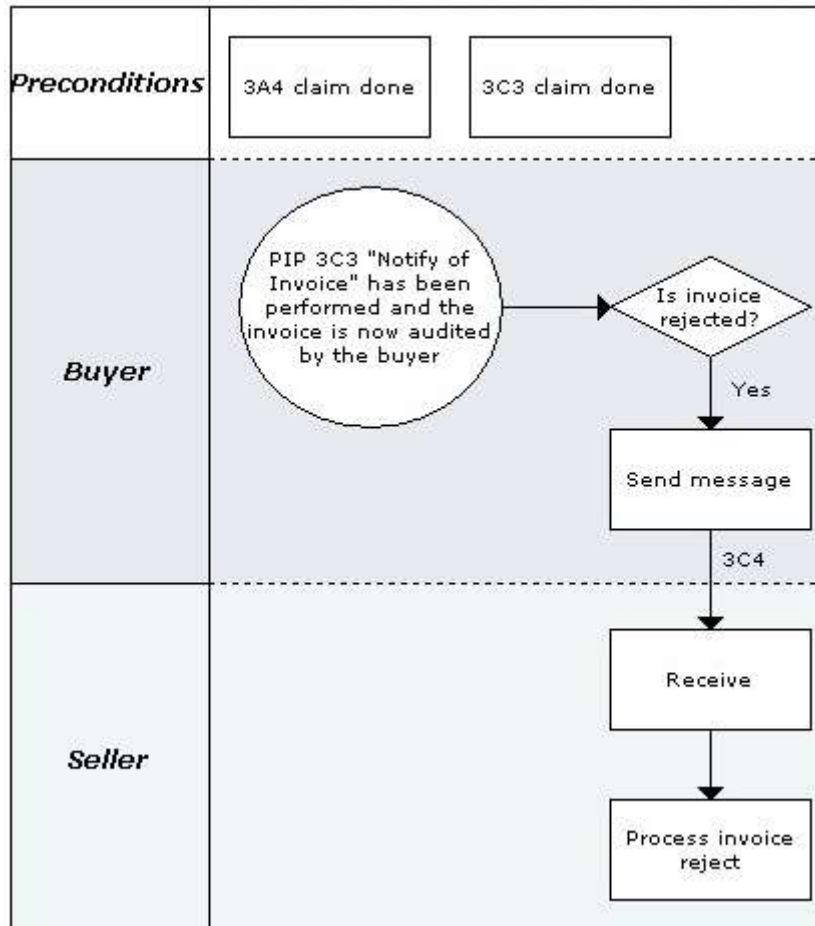

6.3.5 PIP 3C5: Notify of Billing Statement

DTD XML Schema

Purpose: This enables a provider to send a billing statement to another party, such as a buyer.

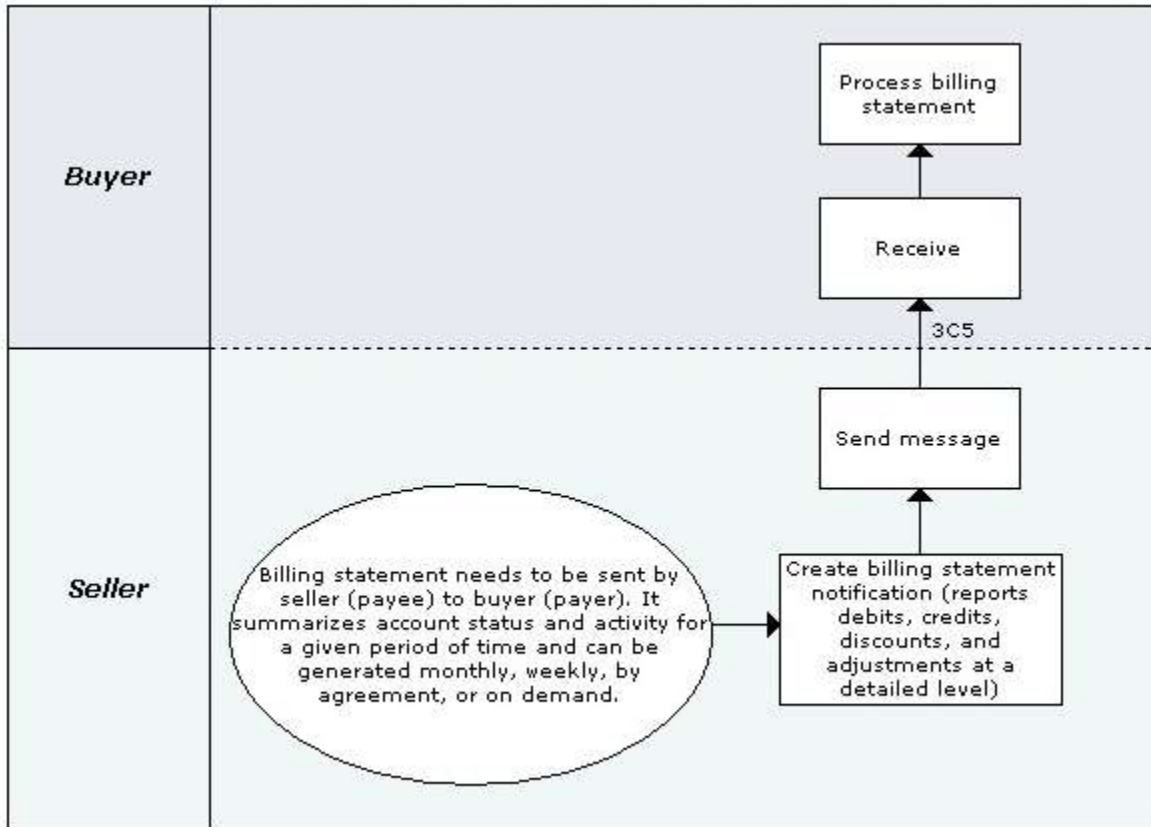

6.3.6 PIP 3C6: Notify of Remittance Advice

DTD XML Schema

Purpose: To issue a Remittance Advice Notification to a Payee. The Payer can be a bank that will then issue the payment amount to the Payee; additionally it can be the Payee to whom payment is being remitted directly. In the former instance, the Payee could use the Remittance Advice Notification to reconcile against either invoices or the billing statement to determine which demands for payment are being paid.

If the payment is not as anticipated, the Payee performs a manual process to determine how to handle the discrepancy.

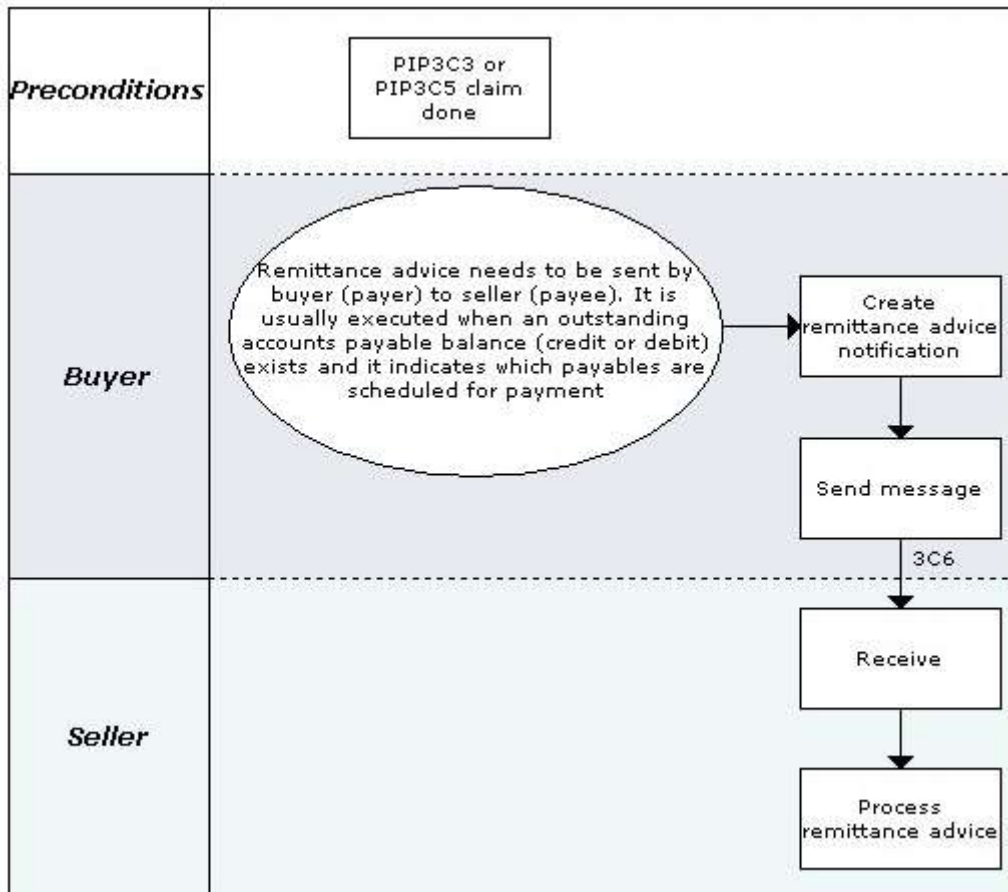

Note: RosettaNet Implementation Guides is available for PIP 3C6 version V01.01.00 (DTD).

6.3.7 PIP 3C7: Notify of Self-Billing Invoice

DTD XML Schema

Purpose: This enables buyers to issue invoice notifications, and lets sellers and financiers validate them.

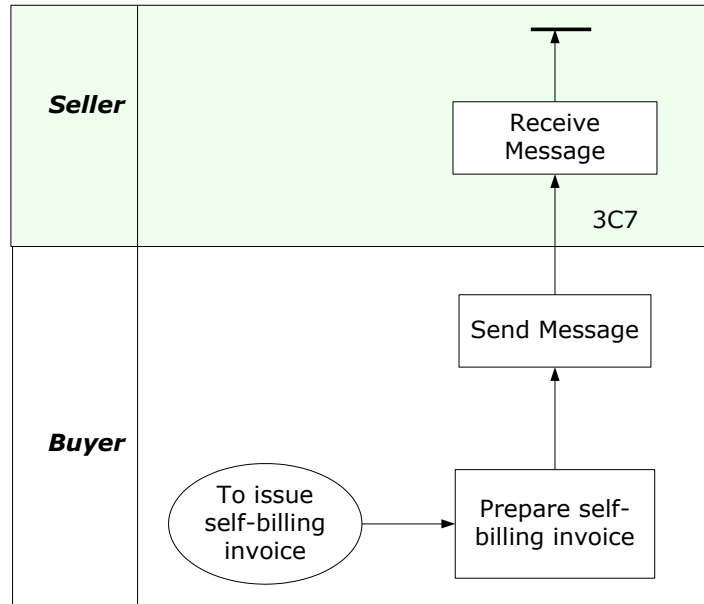

Note: RosettaNet Implementation Guides is available for PIP 3C7 version V01.00.00 (DTD).

6.3.8 PIP 3C8: Notify of Return Product Request

DTD XML Schema

Purpose: This PIP enables a party to notify the OEM of a product return or request authorization to return a product to a supplier.

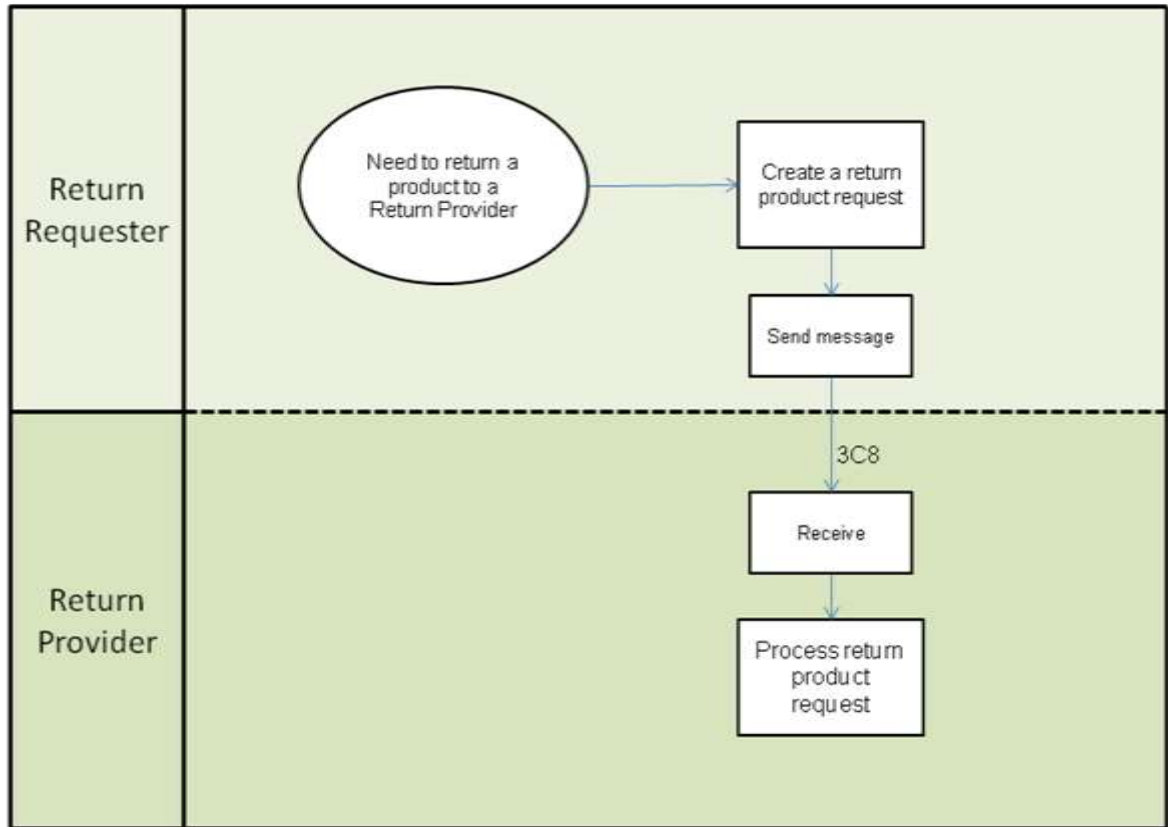

6.3.9 PIP 3C9: Notify of Return Product Confirmation

☒ DTD ☒ XML Schema

Purpose: This PIP enables a Return Provider to respond to the return product request.

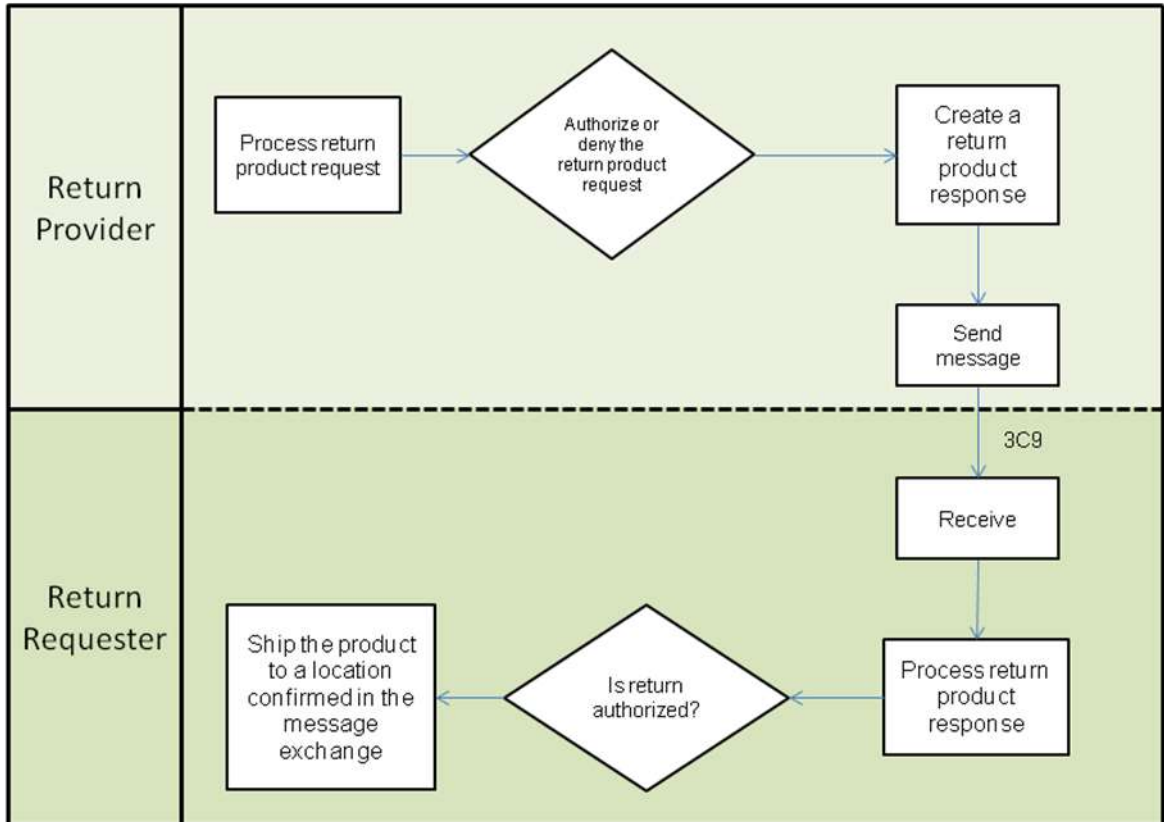

7 Cluster 4: Inventory Management

This cluster enables inventory management, including collaboration, replenishment, price protection, reporting and allocation of constrained product.

7.1 Segment 4A: Collaborative Forecasting

This segment enables standardization of collaborative order and sales forecasting between supply-chain partners.

7.1.1 PIP 4A1: Notify of Strategic Forecast

DTD XML Schema

Purpose: To issue a Sales Forecast Notification to a Forecast Recipient. The periodicity and time horizons of the Sales Forecast, as well as many other parameters, are specified in a Trading Partner Agreement (TPA). The Forecast Recipient has no commitment to be able to supply the product specified in the forecast. The forecast is provided for planning purposes only.

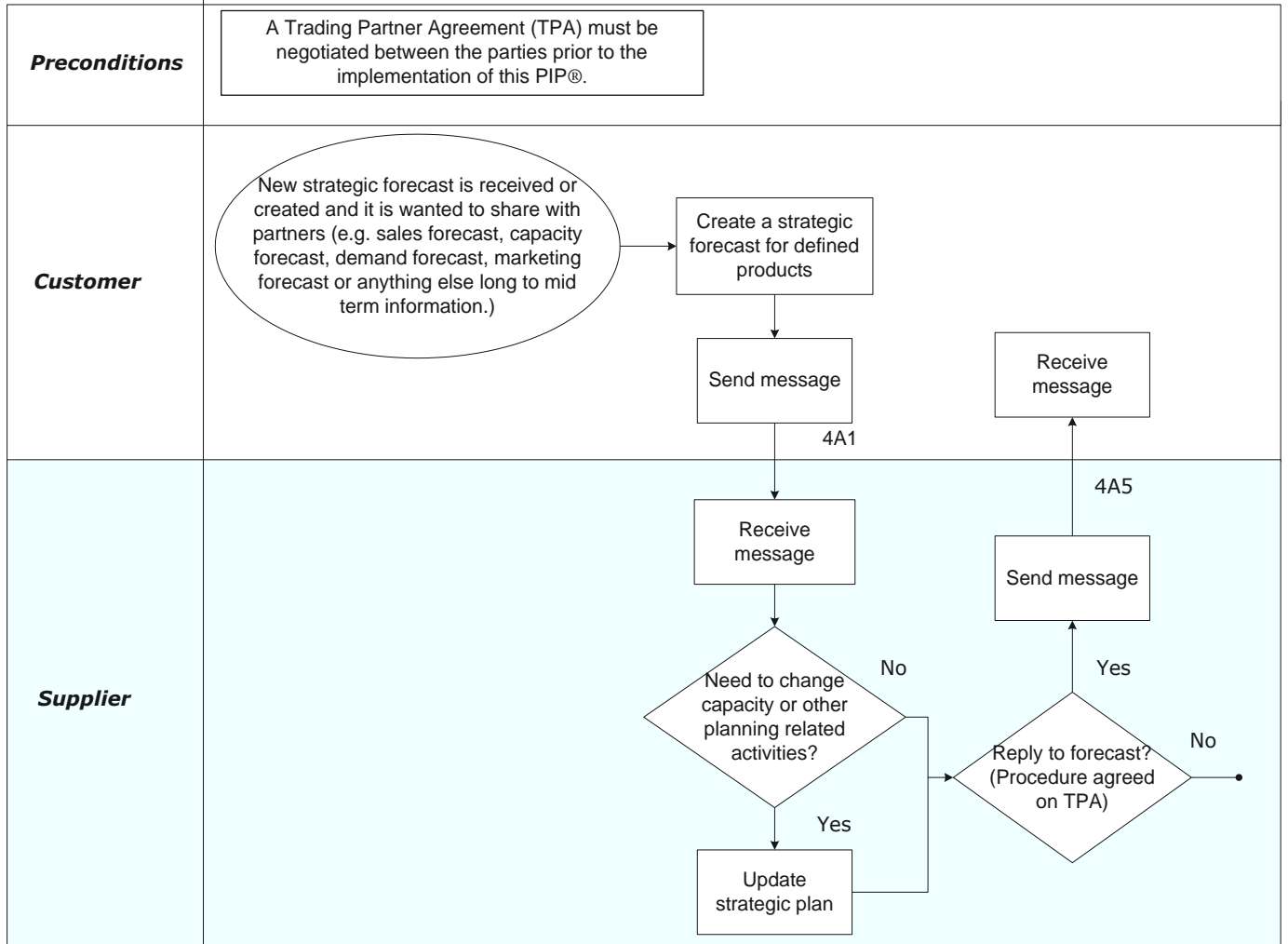

7.1.2 PIP 4A2: Notify of Embedded Release Forecast

DTD XML Schema

Purpose: To issue a standardized collaborative Order Forecast Notification to a Forecast Recipient. The periodicity and time horizons of the Order Forecast, as well as many other parameters, are specified in a Trading Partner Agreement (TPA). The Forecast Recipient has no commitment to be able to supply the product specified in the forecast. The forecast is provided for planning purposes only.

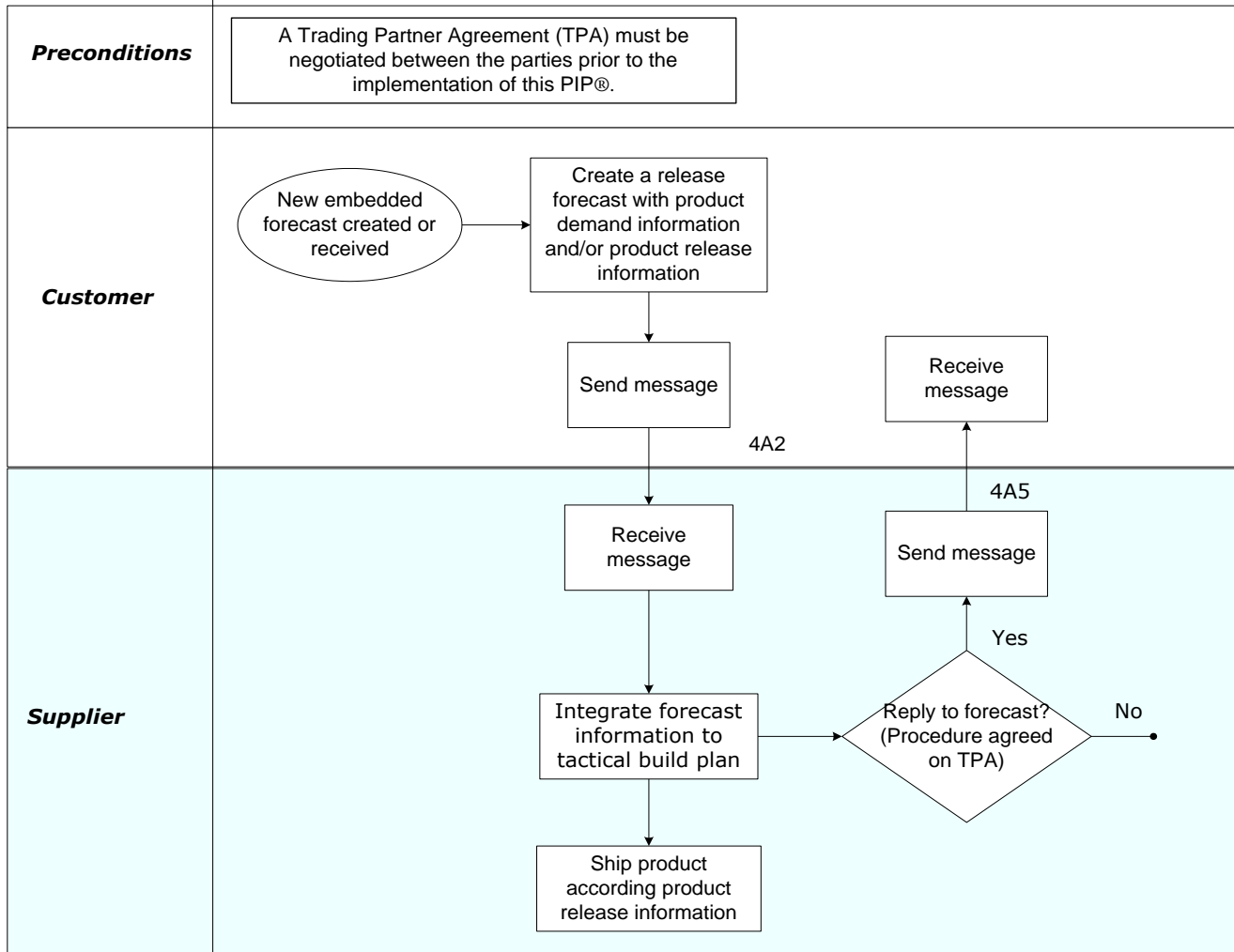

Note: RosettaNet Implementation Guides is available for PIP 4A2 version V02.00.00 (DTD).

7.1.3 PIP 4A3: Notify of Threshold Release Forecast

☒ DTD ☒ XML Schema

Purpose: For a Forecast Owner to submit a Forecast Submittal and receive a Forecast Confirmation from a Forecast Recipient. The collaborative forecast means that the submitted forecast is processed; exceptions are identified and resolved in a highly collaborative manner. The cycle is repeated until complete resolution is achieved.

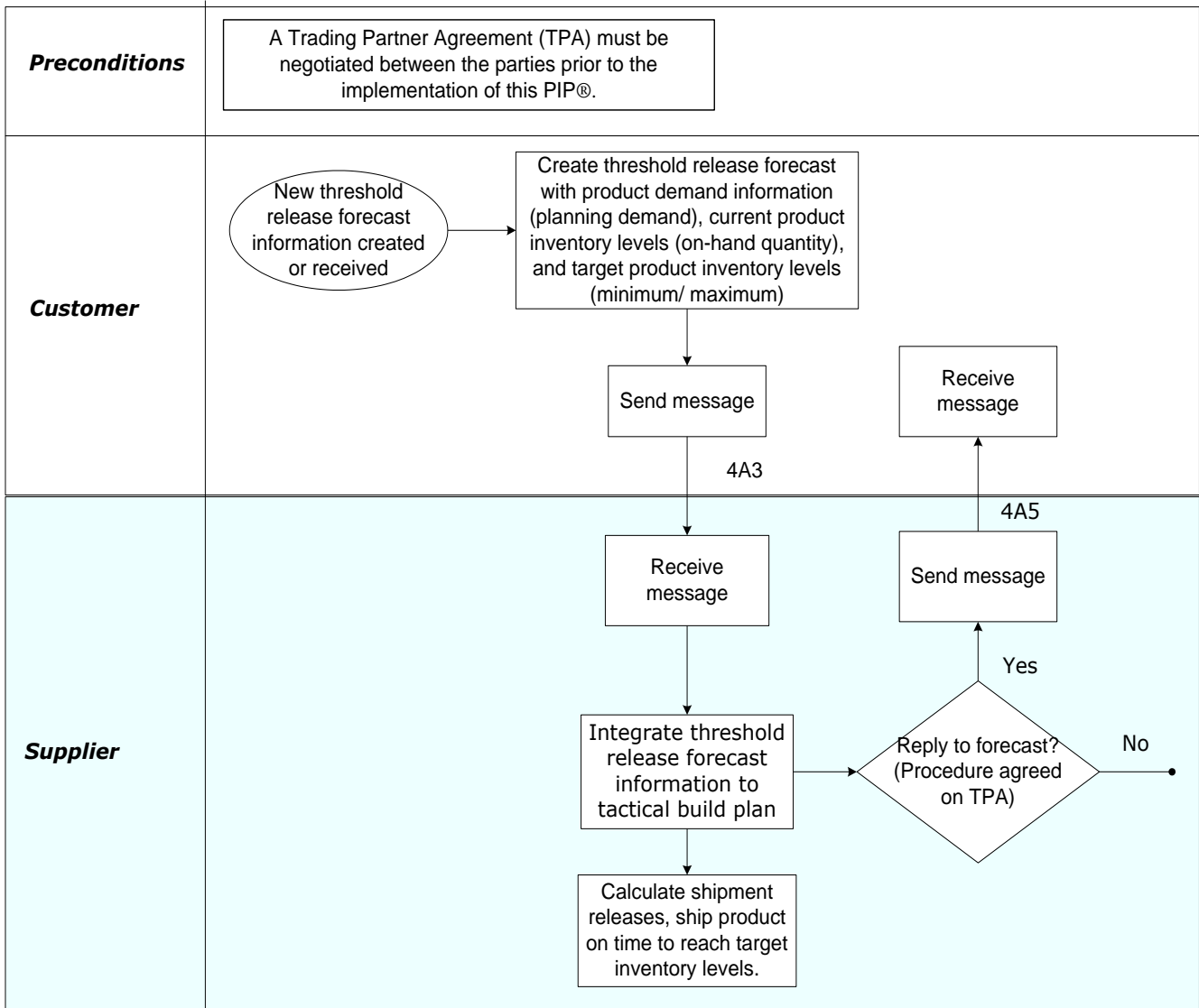

Note: RosettaNet Implementation Guides is available for PIP 4A3 version V01.00.00 (DTD), version V02.01.00 (DTD), and version V02.02.00 (DTD).

7.1.4 PIP 4A4: Notify of Planning Release Forecast

DTD XML Schema

Purpose: For a Forecast Owner to submit a Forecast Notification to a Forecast Recipient. The collaborative forecast means that the submitted forecast is processed; exceptions are identified and resolved in a highly collaborative manner (using this PIP with PIP4A5, "Notify of Forecast Reply"). The cycle is repeated until complete resolution is achieved.

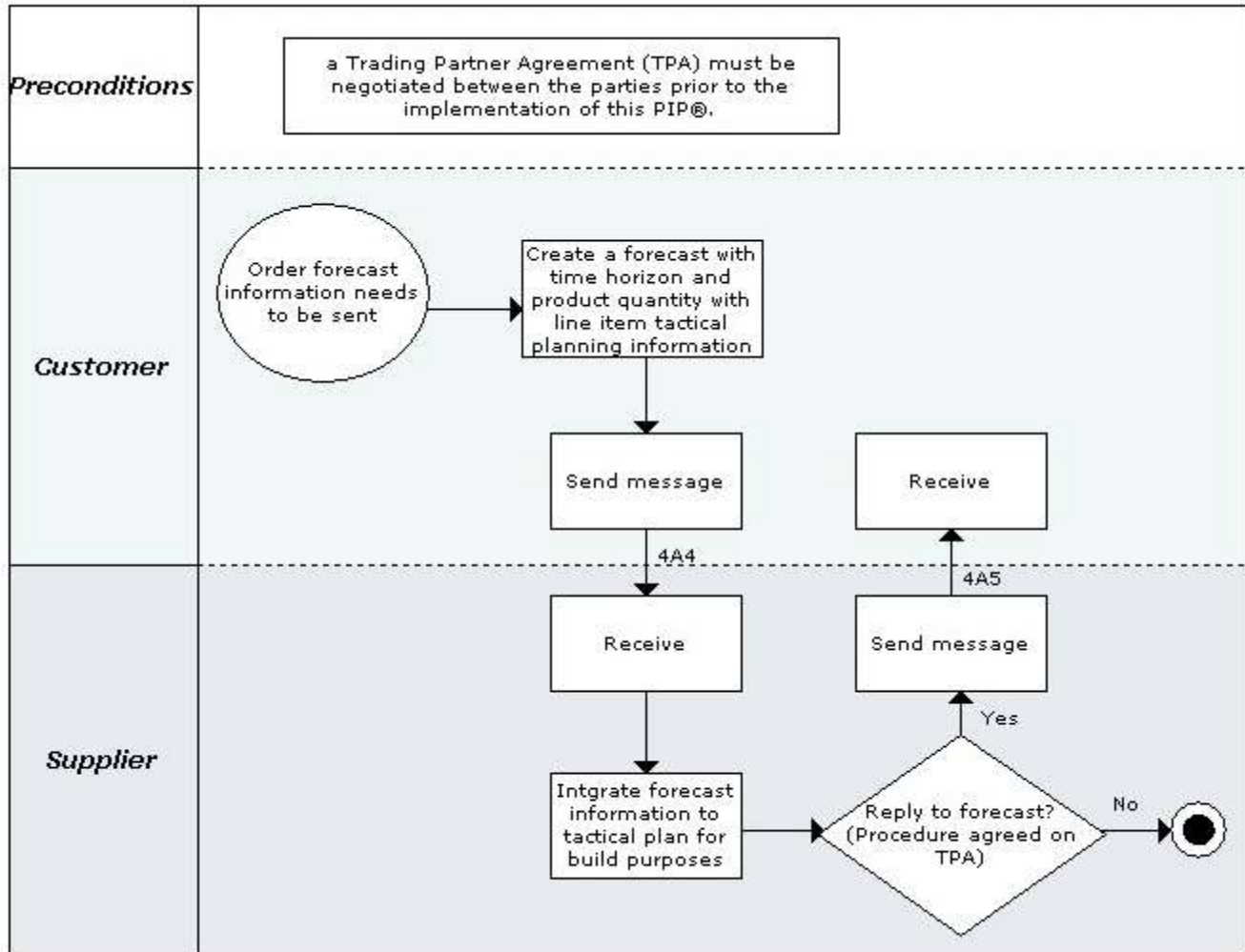

Note: RosettaNet Implementation Guides is available for PIP 4A4 version V03.00.00 (DTD).

7.1.5 PIP 4A5: Notify of Forecast Reply

DTD XML Schema

Purpose: For a Forecast Recipient to submit a Forecast Reply Notification to a Forecast Owner. The collaborative forecast means that submitted forecast is processed; exceptions are identified and resolved in the highly collaborative manner (using this PIP with PIP4A4, "Notify of Planning Release Forecast"). The cycle is repeated until complete resolution is achieved.

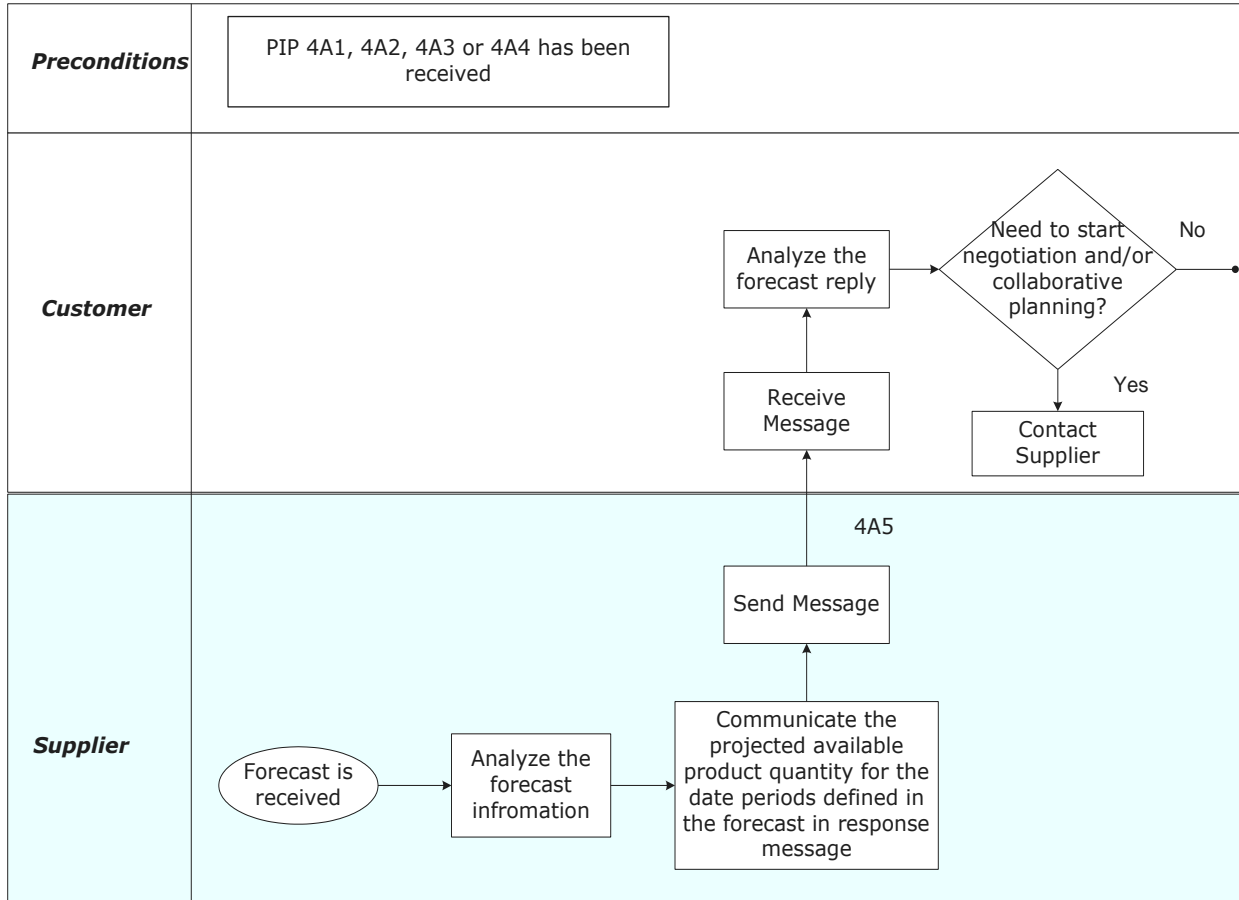

Note: RosettaNet Implementation Guides is available for PIP 4A5 version V01.00.00 (DTD).

7.1.6 PIP 4A6: Notify of Forecasting Exception

DTD XML Schema

Purpose: To support a process where an Exception Identifier notifies an Exception Recipient of identified exceptions within a collaborative forecasting process.

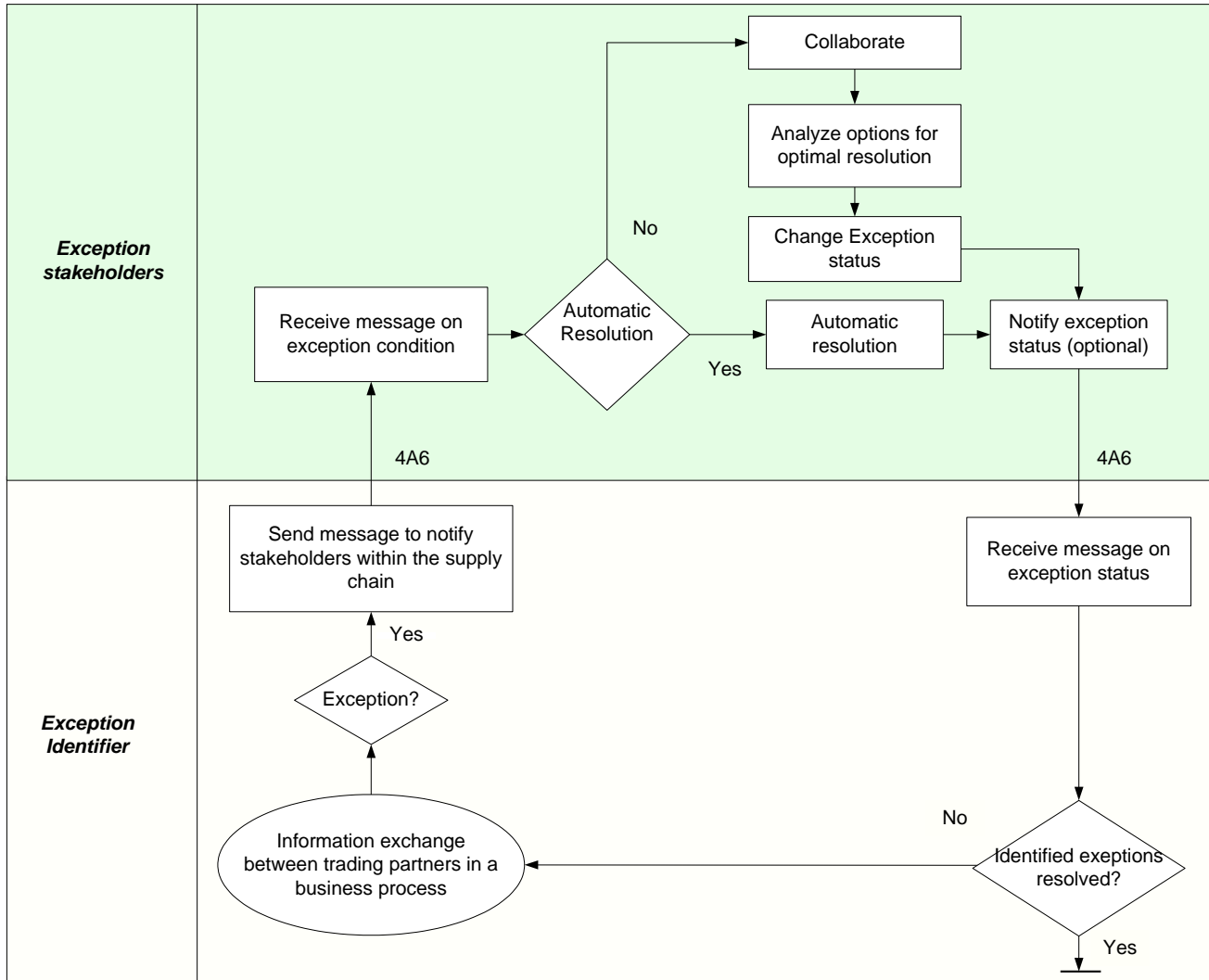

7.2 Segment 4B: Inventory Allocation

This segment lets sellers to inform buyers of product allocation determined through the evaluation of preset criteria, such as demand forecast and availability, and allows buyers to respond manually if negotiation is needed.

7.2.1 PIP 4B2: Notify of Shipment Receipt

DTD XML Schema

Purpose: To support a process used by a consignee to report the status of a received shipment to another interested party, such as another consignee, a transport service provider, a third-party logistics firm, or a shipper. Receipt of a shipment is reported after it has been delivered by a carrier and inspected by receiving personnel.

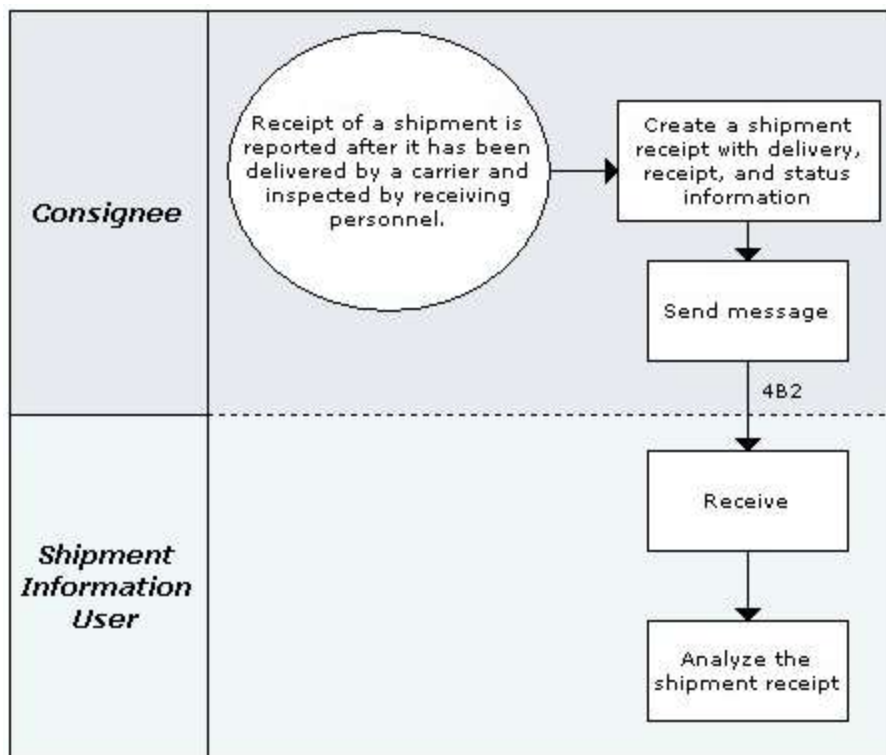

Note: RosettaNet Implementation Guides is available for PIP 4B2 version V01.00.00 (DTD).

7.2.2 PIP 4B3: Notify of Consumption

DTD XML Schema

Purpose: To communicate material consumption to the supplier, allowing the supplier to trigger invoicing for the consumed material.

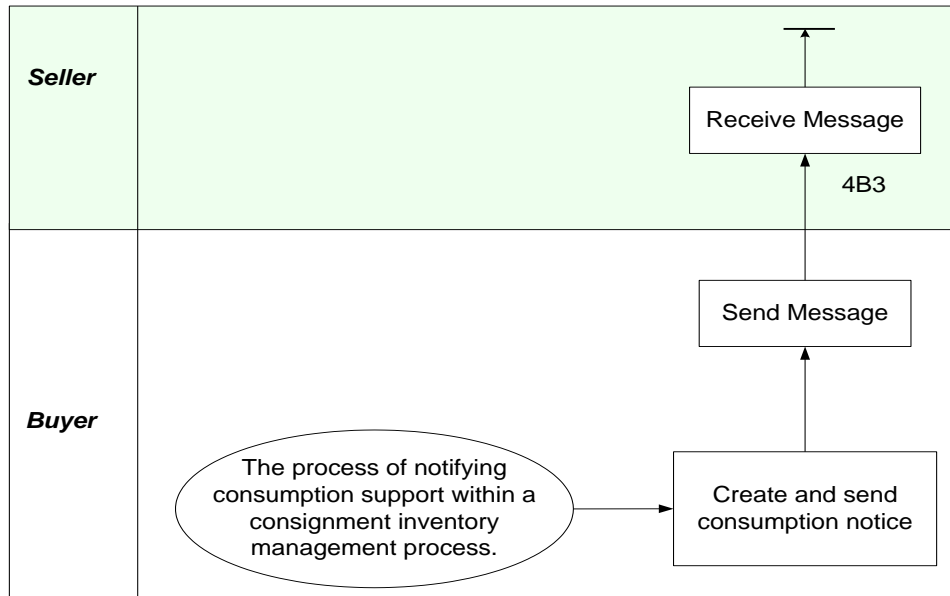

Note: RosettaNet Implementation Guides is available for PIP 4B3 version V01.00.00 (DTD).

7.3 Segment 4C: Inventory Reporting

This segment lets buyers to provide daily inventory reports to sellers, allows sellers to notify buyers when reports are reflected in their records and enables sending of discrepancy reports.

7.3.1 PIP 4C1: Distribute Inventory Report

- DTD
- XML Schema

Purpose: To support a process in which an Inventory Information Provider reports the status of the inventory owned or held by the Inventory Information Provider to an Inventory Information User. The inventory report can include any product, active or inactive, held in inventory.

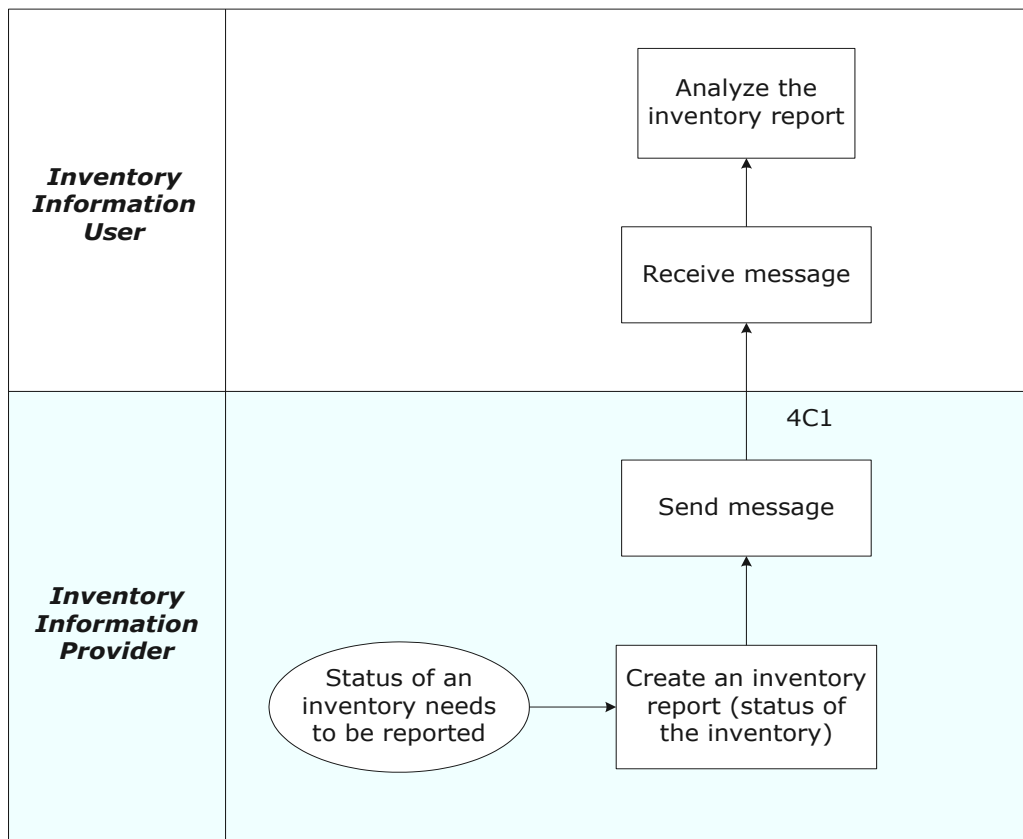

7.4 Segment 4D: Inventory Replenishment

This segment facilitates inventory replenishment managed by buyer, seller or both -- via a pull signal from the buyer or push notification from the seller that triggers an order, change, ship or return.

7.4.1 PIP 4D1: Notify of Material Release

- DTD
- XML Schema

Purpose: To provide a mechanism for a Replenishment Manager to trigger inventory replenishment.

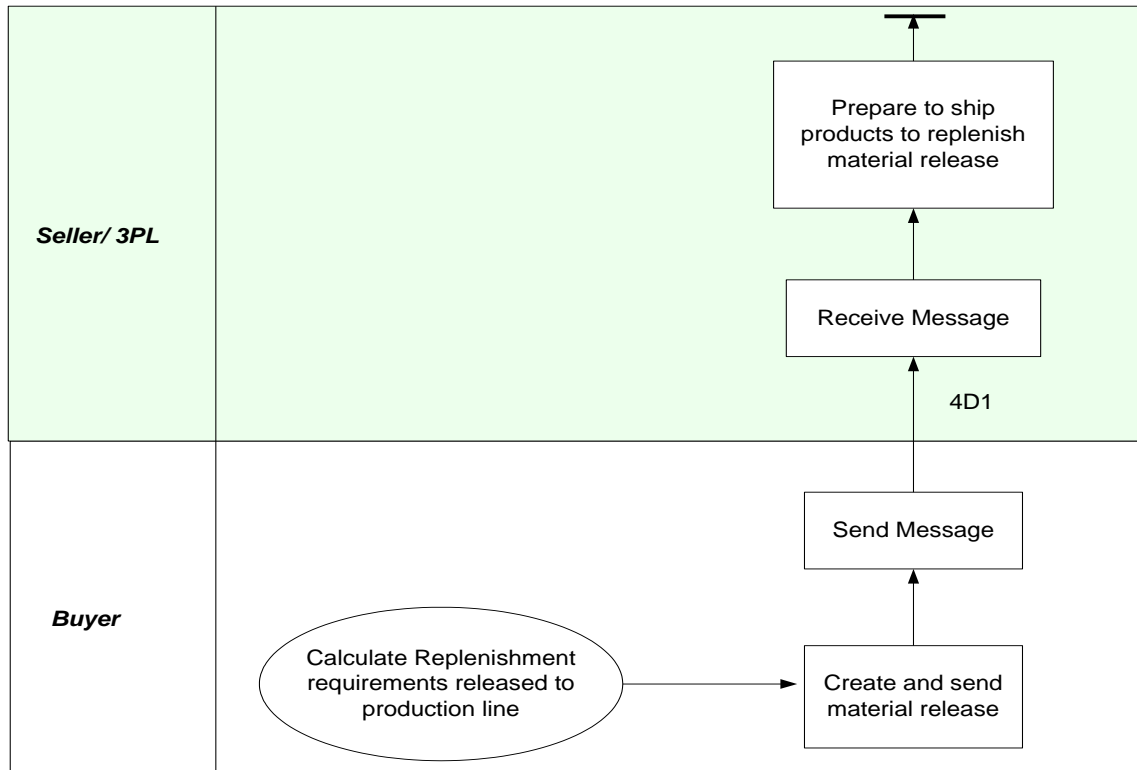

Note: RosettaNet Implementation Guides is available for PIP 4D1 version V01.00.01 (DTD).

7.5 Segment 4E: Sales Reporting

This segment lets buyers to provide periodic sales reports to product providers, allows providers to notify buyers when reports are reflected in their records and enables sending of discrepancy reports.

7.5.1 PIP 4E1: Notify of Sales Report

DTD XML Schema

Purpose: To notify the Product Seller of Sales of an active contracted GTIN.

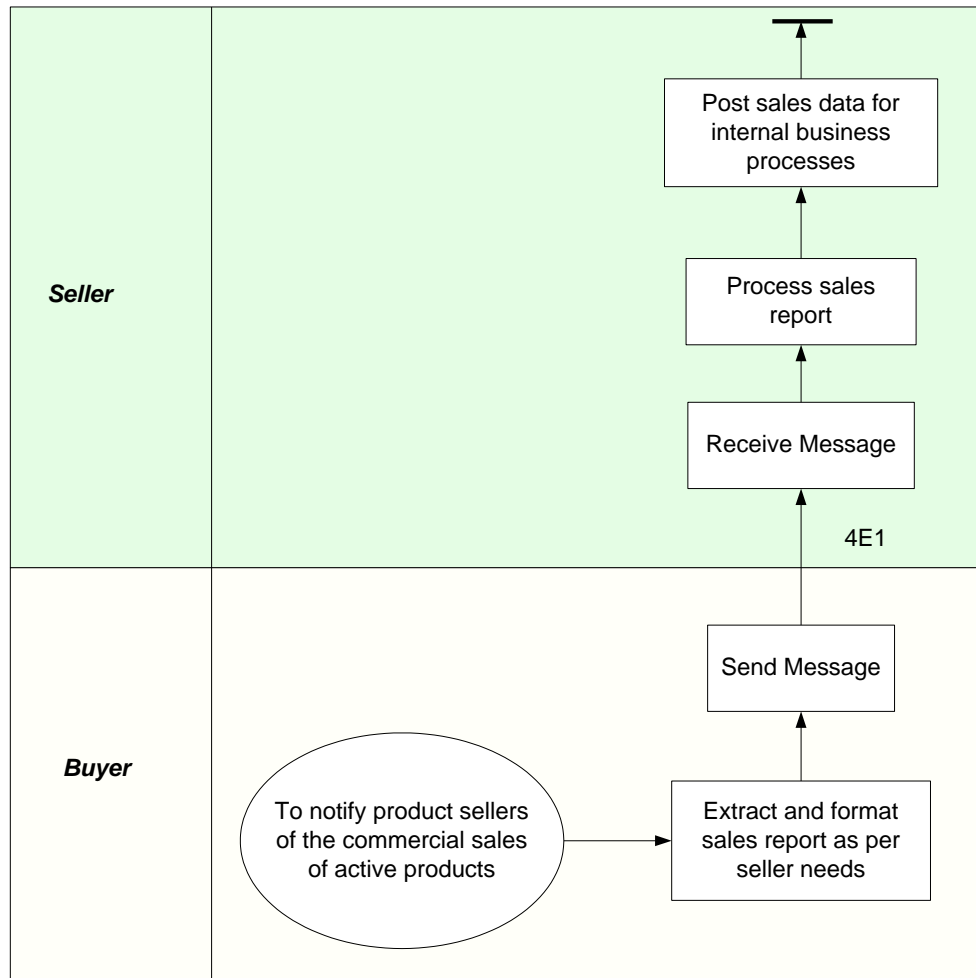

Note: RosettaNet Implementation Guides is available for PIP 4E1 version V11.00.00 (XML Schema)

7.5.2 PIP 4E2: Notify of Sales Report Acknowledgement

DTD XML Schema

Purpose: To notify the Product Seller of Sales on an active contracted GTIN.

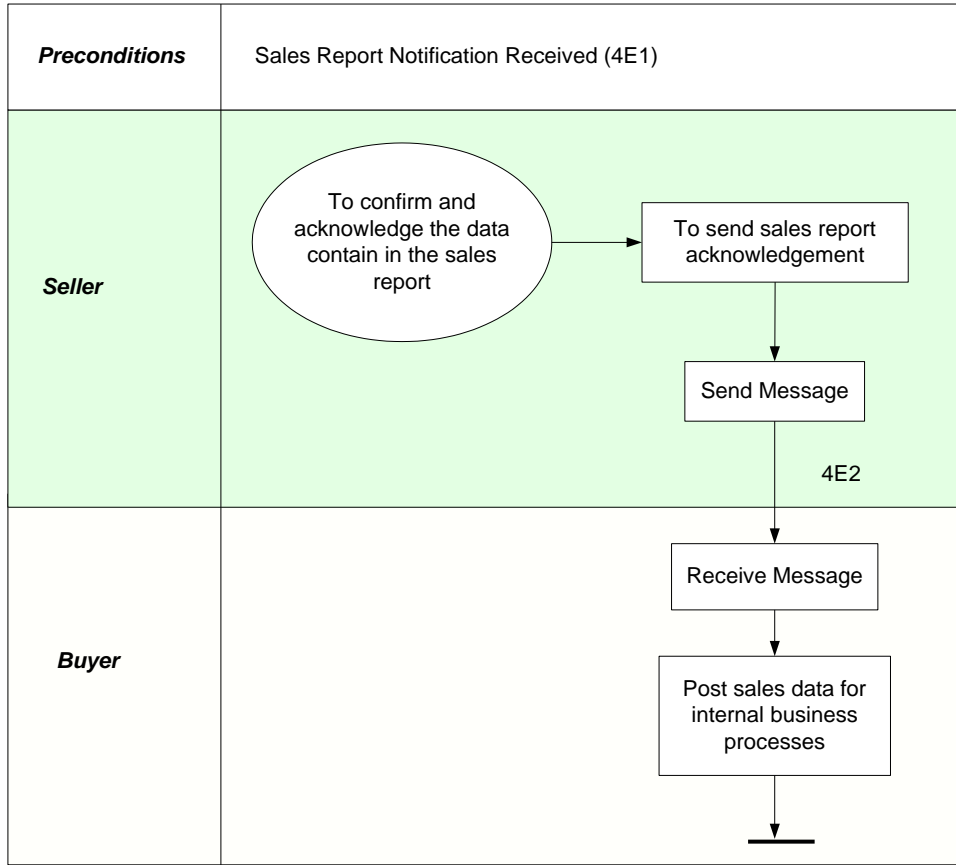

8 Cluster 5: Marketing Information Management

This cluster provides the ability to share sales lead information, including opportunity status.

8.1 Segment 5C: Design Win Management (Electronic Components)

This segment enables design registration with suppliers, including requests for design-win registration at different phases of the design cycle and award of win based on predefined criteria.

8.1.1 PIP 5C1: Distribute Product List

DTD XML Schema

Purpose: To enable a provider to distribute a list of products eligible for design registration to a party needing differentiated products (demand creator). The following product types may be registered: key product, associated product, and development tools.

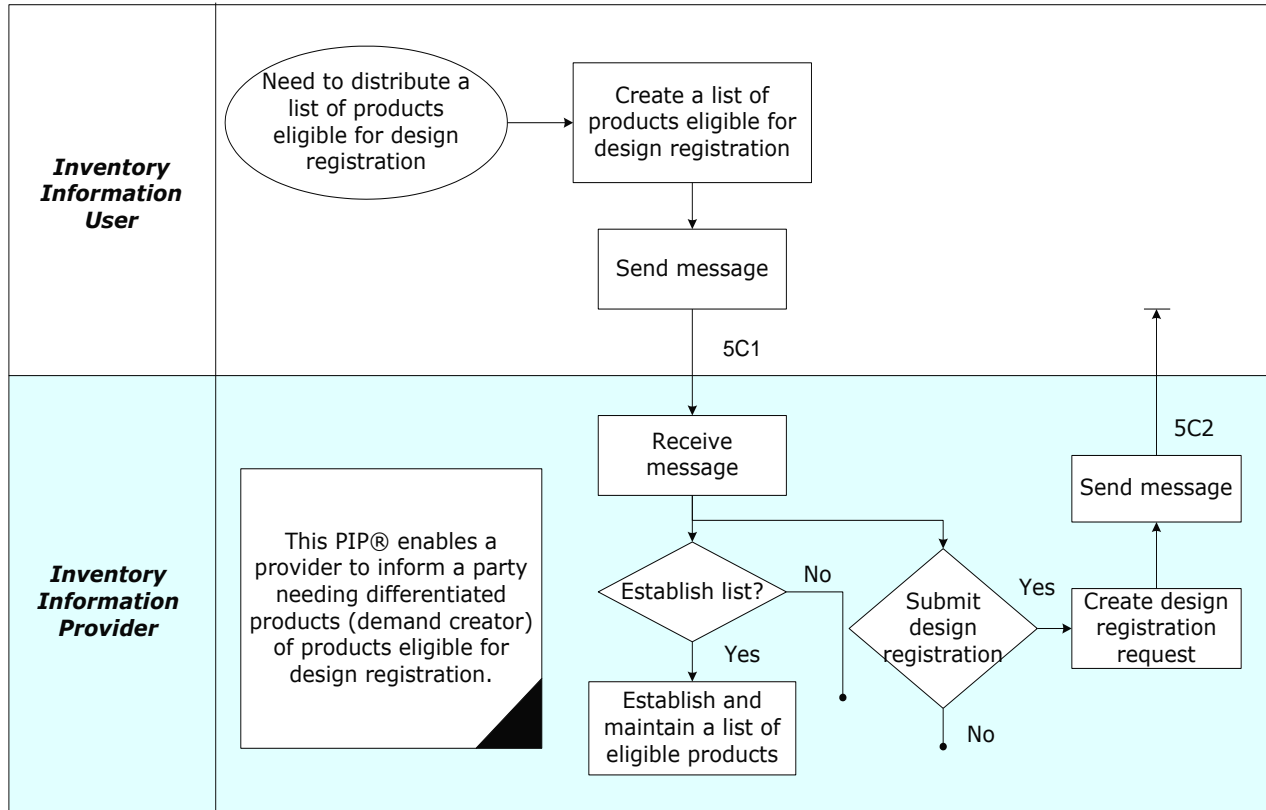

8.1.2 PIP 5C2: Request Design Registration

☒ DTD ☒ XML Schema

Purpose: To allow a Demand Creator to submit a Design Registration Request and receive a Design Registration Response from the Product Provider. A Design Registration Request could be submitted as initial design registration document or as an update to the existing design registration. Dates, confidence level, and detailed technical information can be changed as part of the update and refining of the design registration.

The Product Provider assesses design registration and responds with the Design Registration Response that contains design registration, identifying numbers and a registration status that is an indicator of acknowledgement, collaboration and continuation on the submitted supplier part business opportunity between a Product Provider and a Demand Creator.

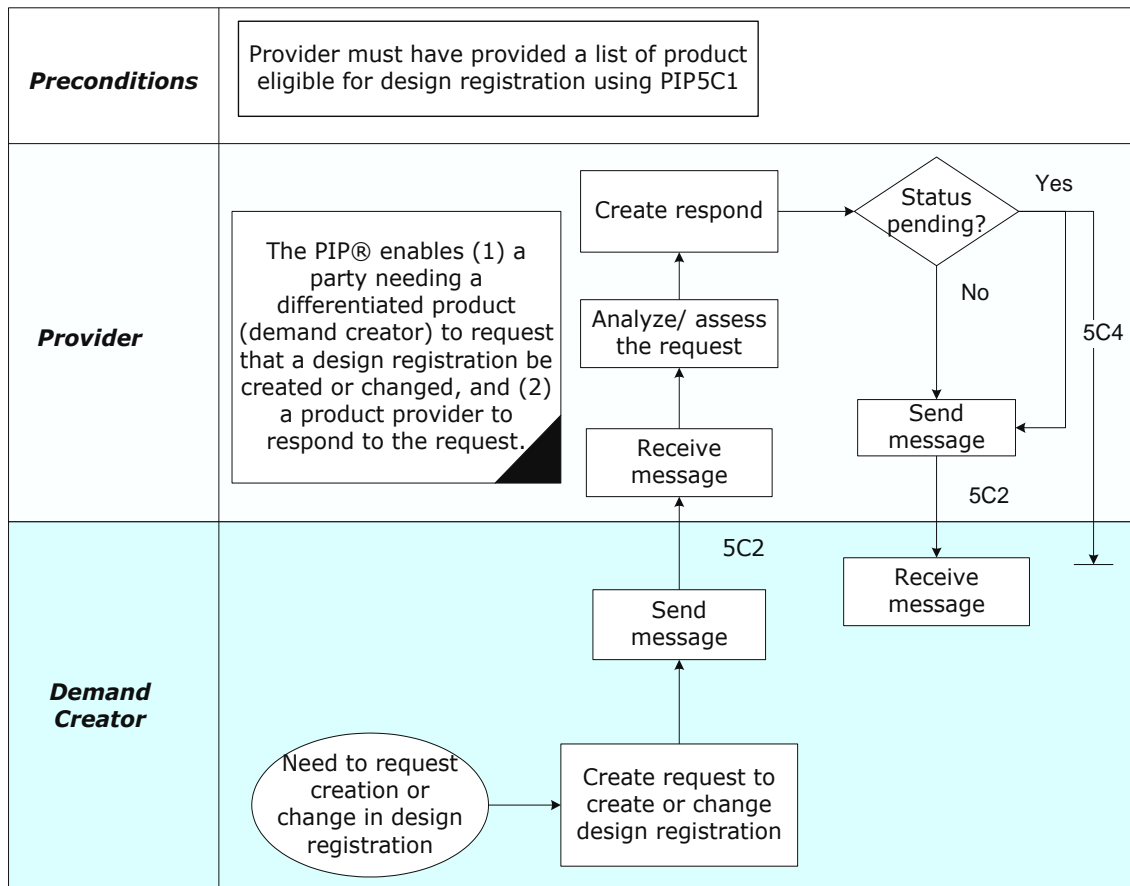

Note: RosettaNet Implementation Guides is available for PIP 5C2 version V01.01.00 (DTD).

8.1.3 PIP 5C3: Create Design Win

☒ DTD ☒ XML Schema

Purpose: For a Demand Creator to submit a Win Claim Request and to receive a Win Claim Response from the Product Provider at various stages of the Design Win process. A Win Claim Request and Win Claim Response could be submitted at multiple stages as the Design Win process advances. Five levels of Win Claim are available, as established by Trading Partners in terms and conditions.

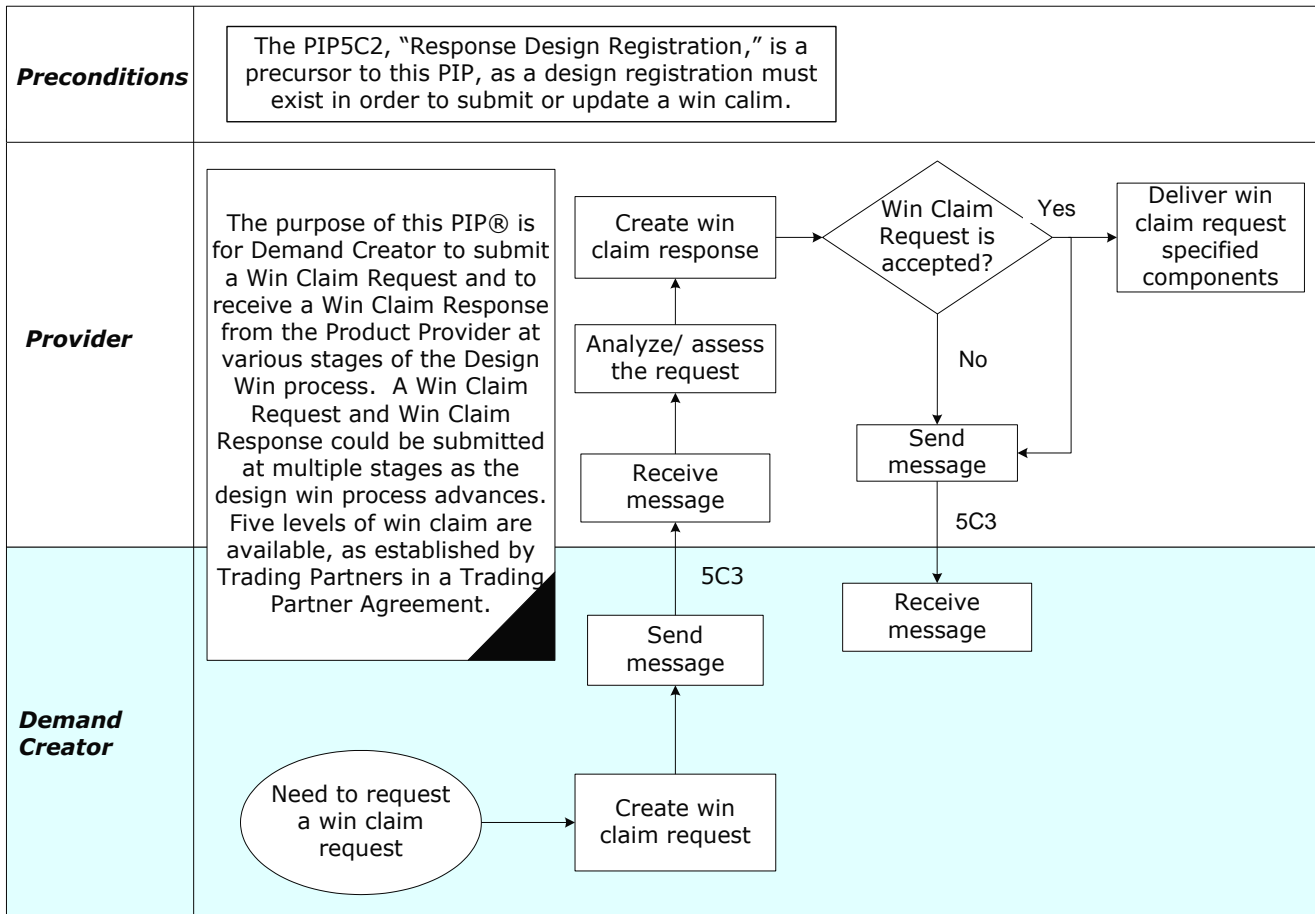

Note: RosettaNet Implementation Guides is available for PIP 5C3 version V01.01.00 (DTD).

8.1.4 PIP 5C4: Distribute Registration Status

- DTD
- XML Schema

Purpose: This enables a provider to send an unsolicited design registration change to a party who has registered a design (demand creator). For example, a provider might send out updates for all registrations related to a sales representative in a specific territory. Registration status can be provided at the core product or the complete product levels.

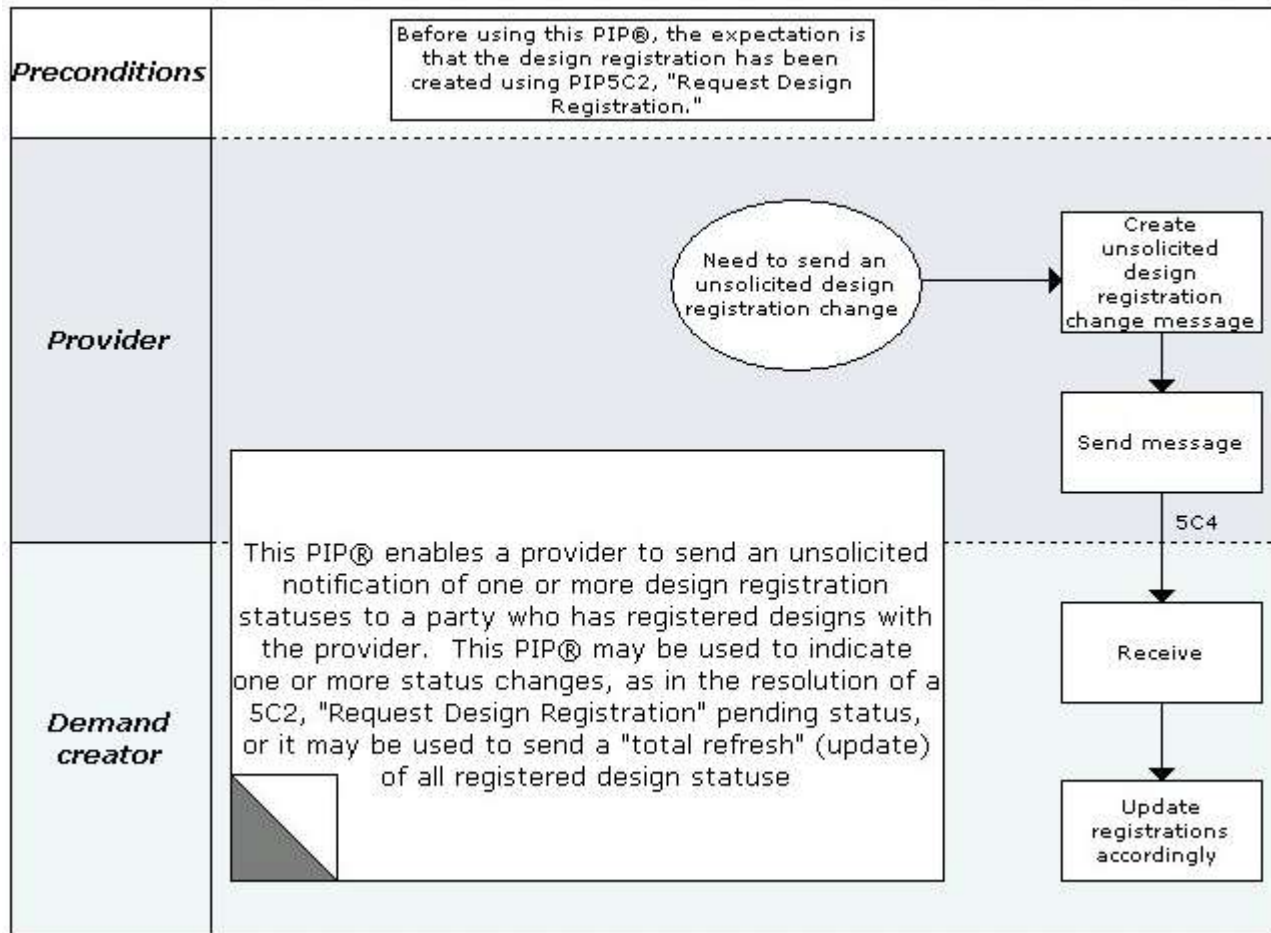

Note: RosettaNet Implementation Guides is available for PIP 5C4 version V01.05.00 (DTD).

8.1.5 PIP 5C5: Query Registration Status

DTD XML Schema

Purpose: To allow a Status Requester, who could be a Product Provider or a Demand Creator, to request status on the design registrations. The Query Registration Status Business Document can be used to request a registration status that is an indicator of acknowledge, collaboration and continuation on the submitted supplier business opportunity.

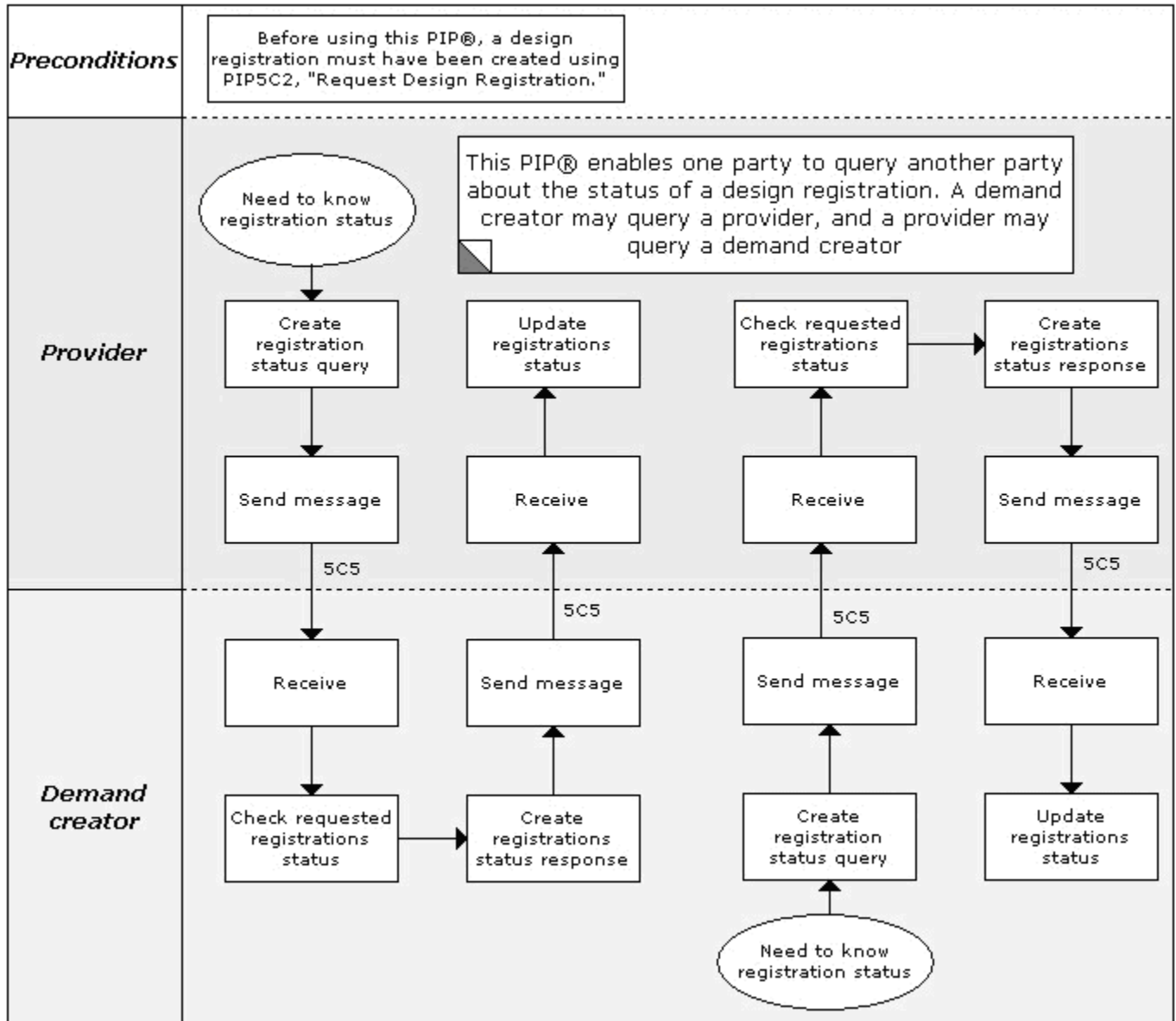

8.1.1 PIP 5C6: Notify of Design Registration Request

☒ DTD ☒ XML Schema

Purpose: This PIP enables a party needing a differentiated product (demand creator) to request that a design registration be created or changed.

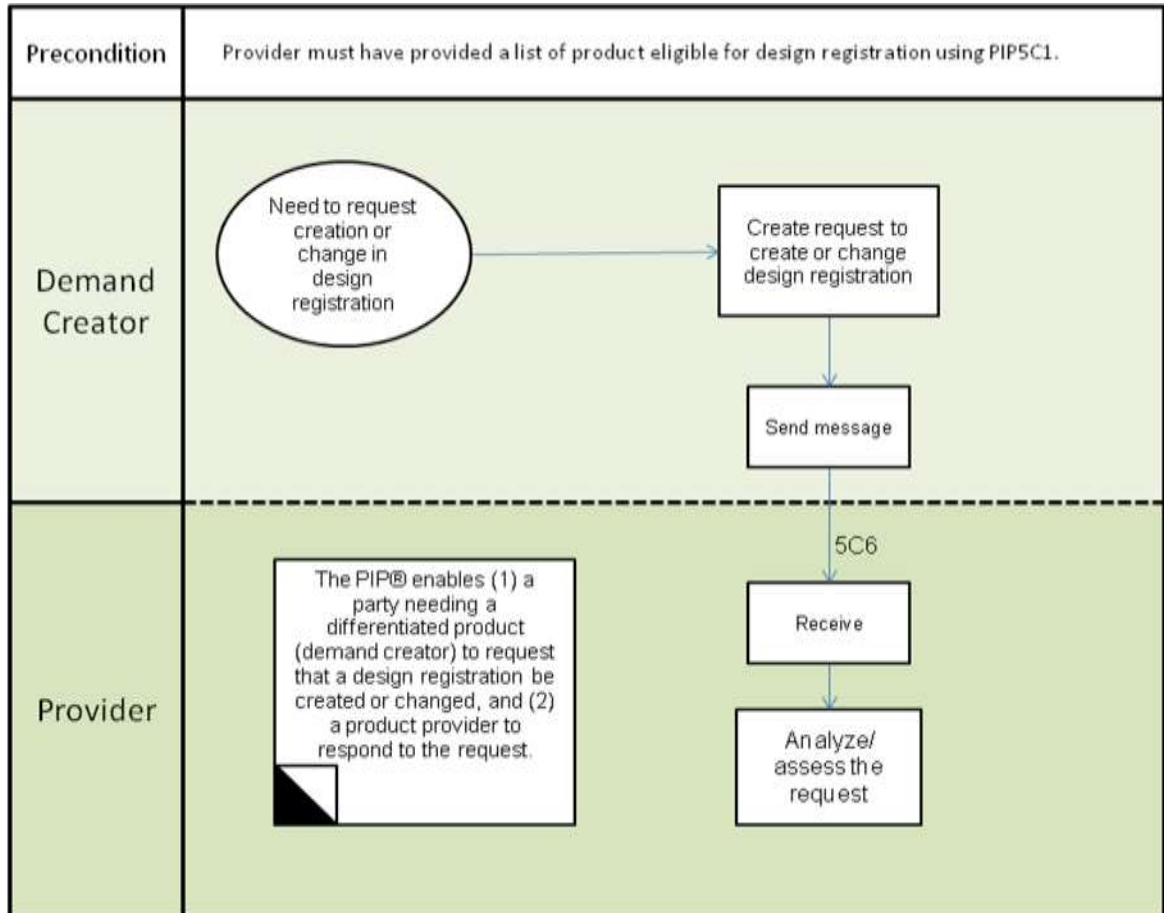

8.1.6 PIP 5C7: Notify of Design Registration Confirmation

DTD XML Schema

Purpose: This PIP enables a product provider to respond to a request.

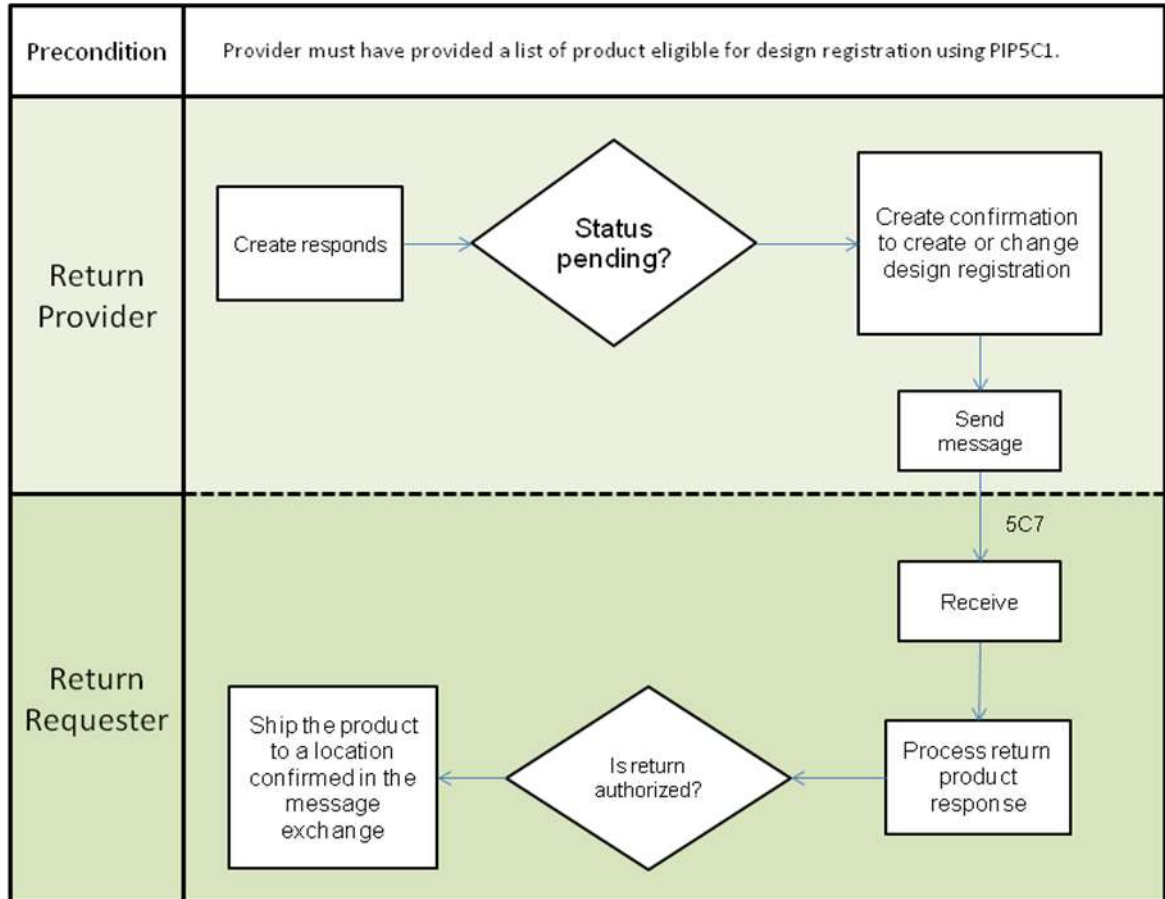

8.1.7 PIP 5C8: Notify of Win Claim Request

☒ DTD ☒ XML Schema

Purpose: This PIP enables a party, for whom design registration win metrics have been met, to offer a win claim request.

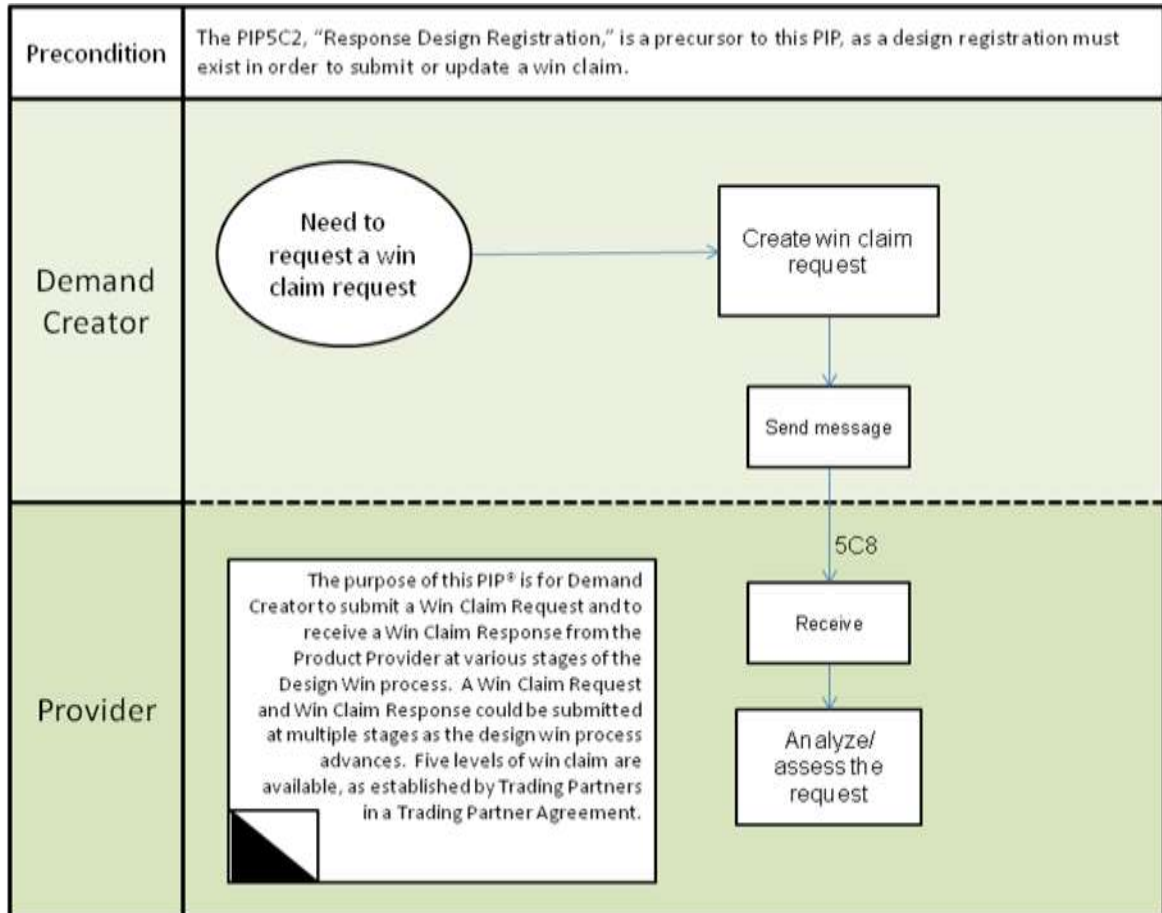

8.1.8 PIP 5C9: Notify of Win Claim Confirmation

DTD XML Schema

Purpose: This PIP enables a provider to respond to the win claim request.

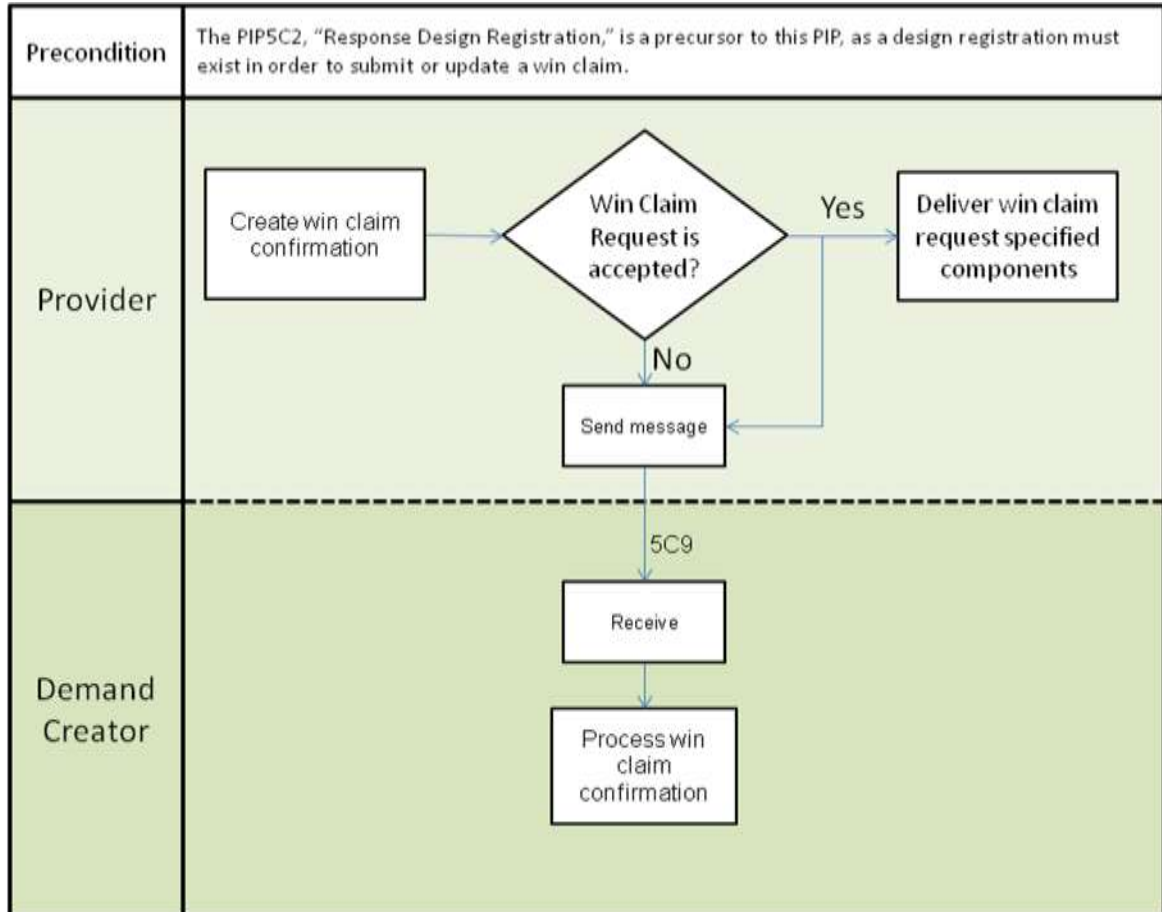

8.2 Segment 5D: Ship from Stock and Debit (Electronic Components)

This segment lets product distributors to submit ship from stock and debit authorization requests to product suppliers, and let product suppliers send debit authorization numbers to product distributors via ship and debit authorization responses.

8.2.1 PIP 5D1: Request Ship from Stock and Debit Authorization

DTD XML Schema

Purpose: To allow a Product Distributor to submit a Ship from Stock and Debit Authorization Request to the Product Supplier. In return, the Product Supplier sends a Debit Authorization Number via a Ship from Stock and Debit Authorization Response to the Product Distributor.

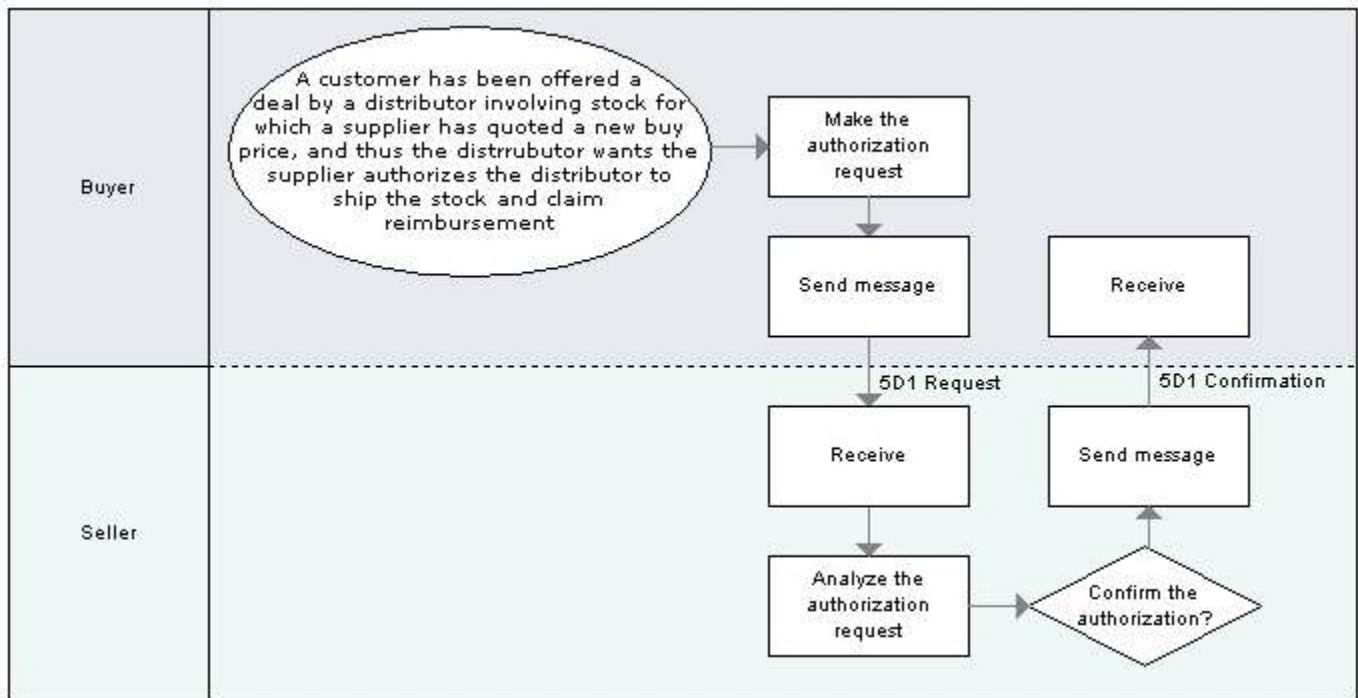

Note: RosettaNet Implementation Guides is available for PIP 5D1 version V01.00.00 (DTD).

8.2.2 PIP 5D2: Notify of Blanket Ship from Stock and Debit Authorization

DTD XML Schema

Purpose: To support the process used by a supplier to send a blanket ship from stock and debit authorization to a distributor. The blanket authorization notifies a distributor of a new quoted price for one or more product items, thus enabling a supplier to initiate discounts via the ship from stock and debit process.

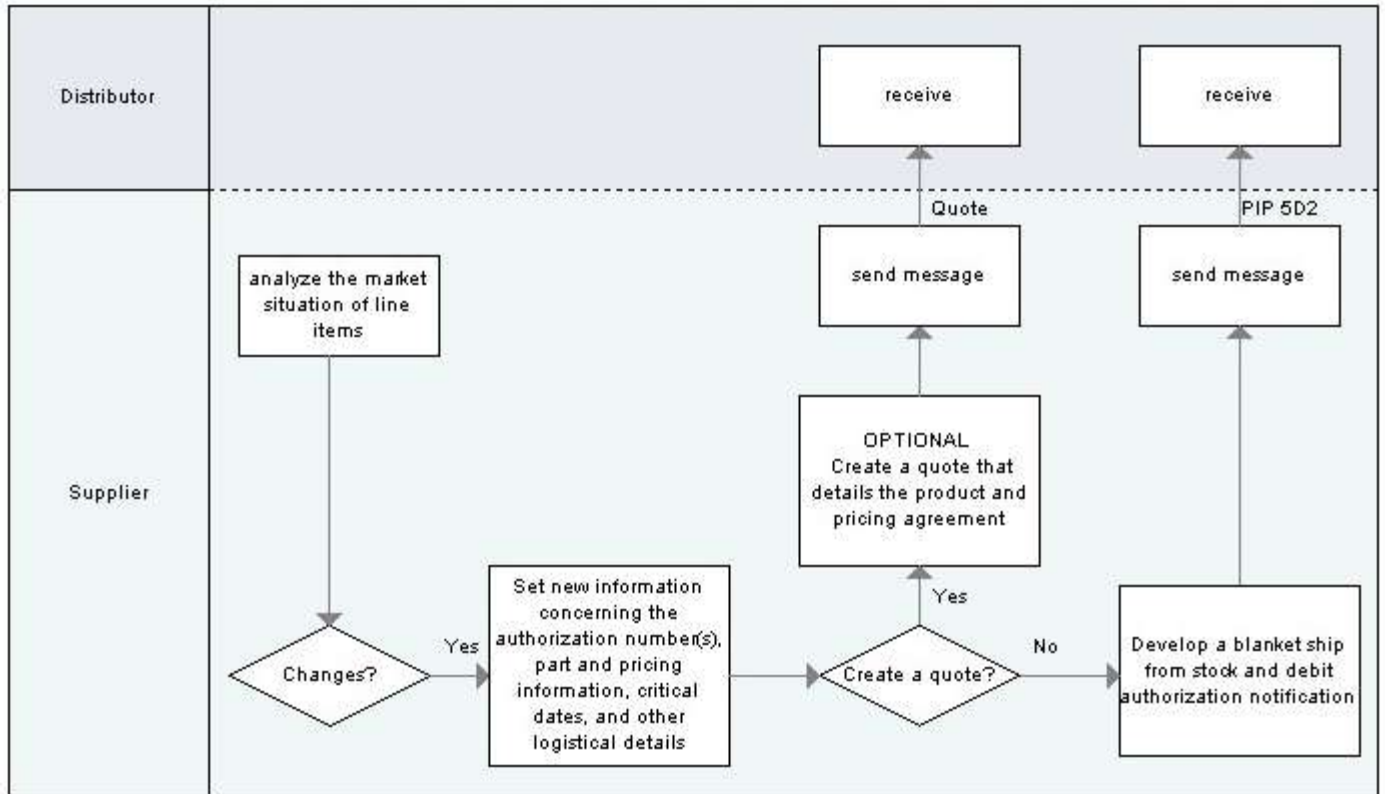

8.2.3 PIP 5D3: Distribute Open Ship from Stock and Debit Authorization Status

DTD XML Schema

Purpose: This enables a Product Supplier to send a Product Distributor a detailed report (list) of existing Open Ship from Stock and Debit Authorizations. It includes such details as the remaining authorized quantity and critical dates for specific customers. It can include Ship from Stock and Debit Authorizations initiated by the distributor, the supplier, or both.

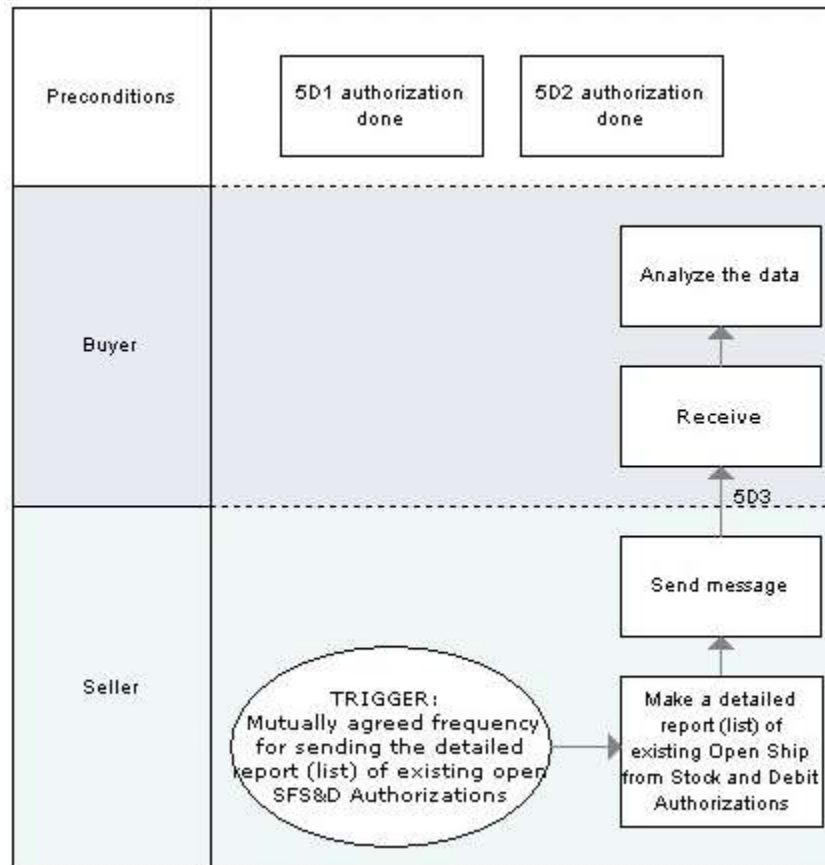

Note: RosettaNet Implementation Guides is available for PIP 5D3 version V01.00.00 (DTD).

8.2.4PIP 5D4: Query Ship from Stock and Debit Authorization Status

DTD XML Schema

Purpose: To allow a Product Distributor to request status on a Ship from Stock and Debit Authorization in addition, the Product Supplier provides that authorization status via a Ship from Stock and Debit Authorization Response.

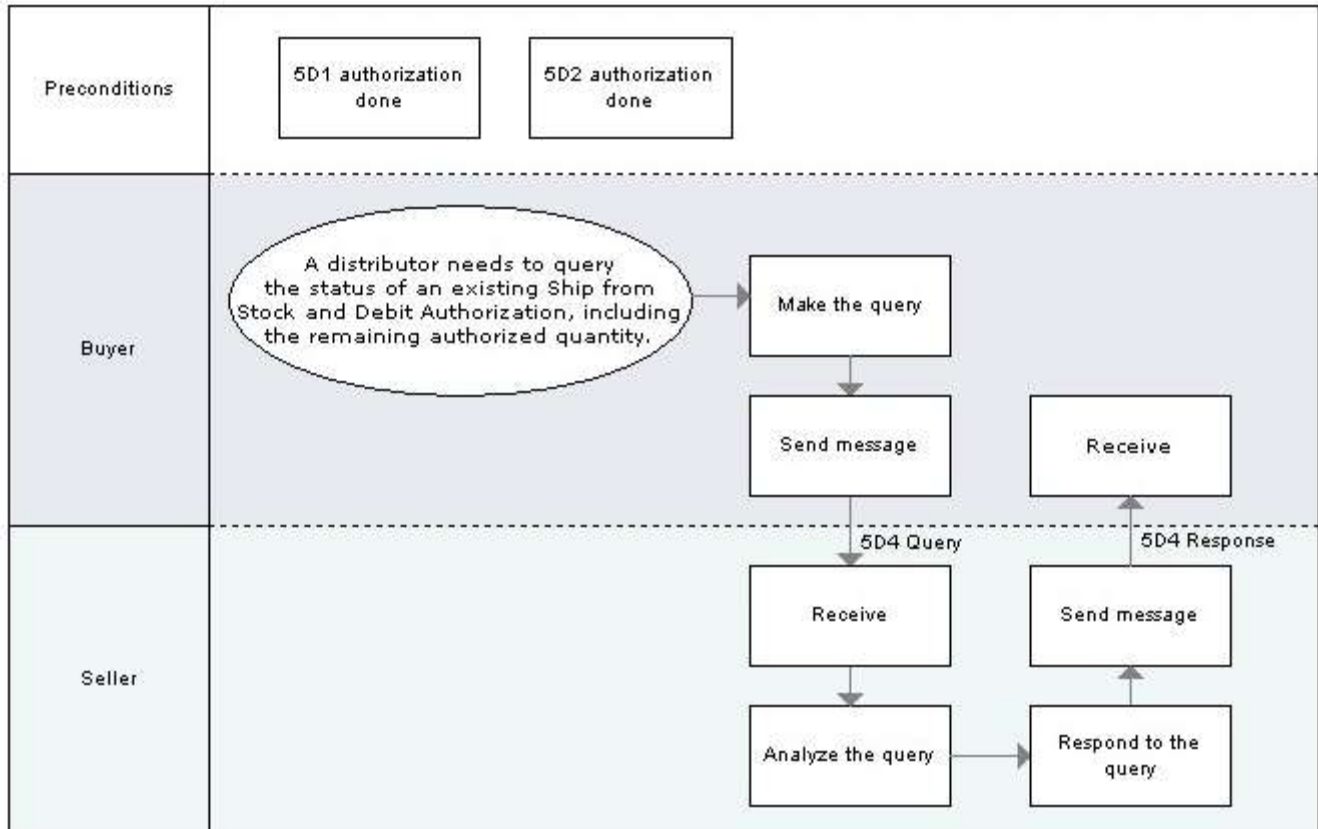

8.2.5 PIP 5D5: Create Ship from Stock and Debit Claim Status

DTD XML Schema

Purpose: To submit a claim for a debit against an authorization program, and to receive a claim response. The Product Supplier performs edits against the product quantities, date of sale, and other information in the claim. By line item, the claim is then accepted, rejected or pending. If accepted, this process triggers the Product Supplier's financial system to generate a credit issued to a Product Distributor. Rejected lines are reported with multiple reason codes, allowing the Product Distributor to close out the item as uncollectible, or to fix the problem and resubmit the claim.

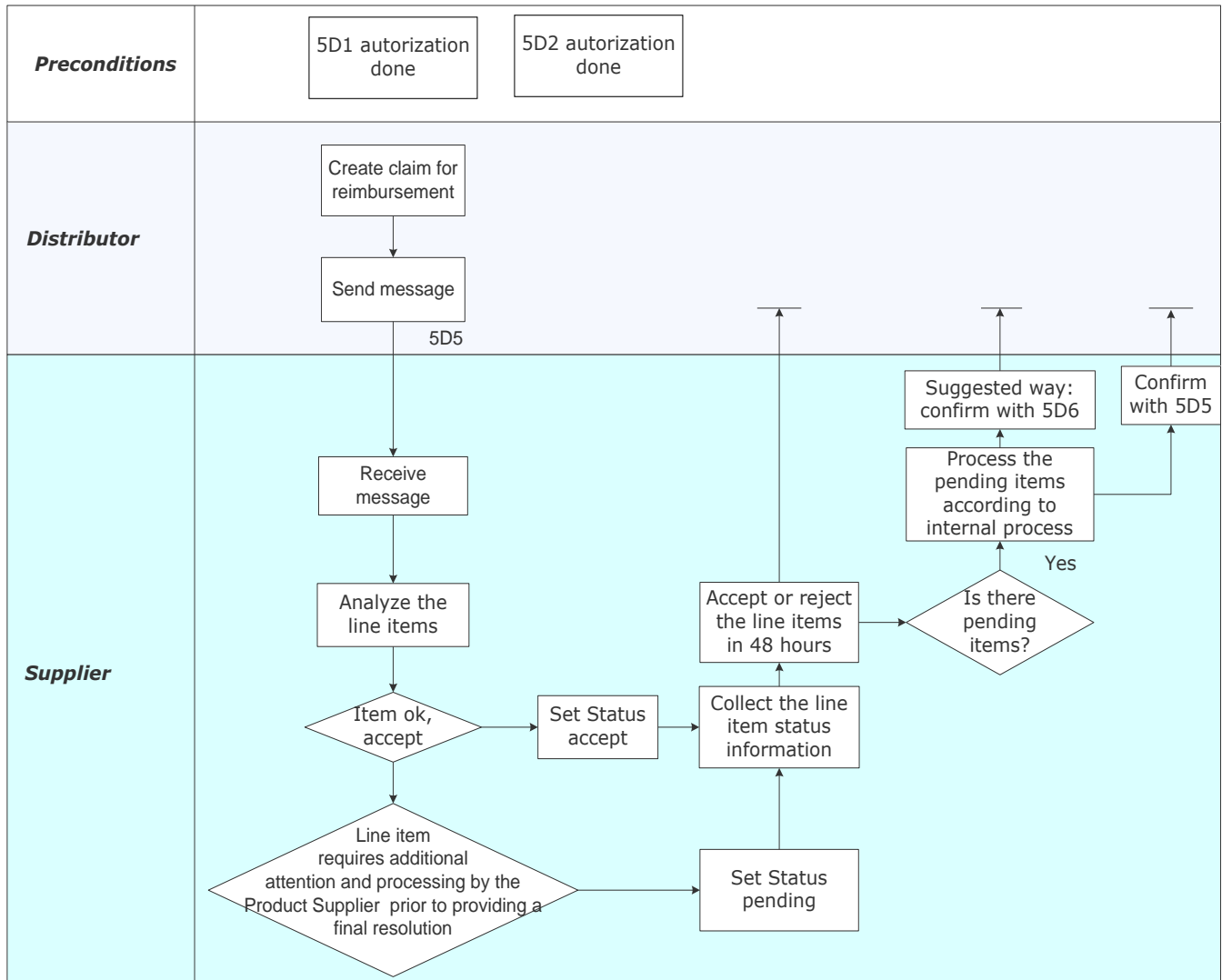

Note: RosettaNet Implementation Guides is available for PIP 5D5 version V01.00.00 (DTD).

8.2.6 PIP 5D6: Notify of Ship from Stock and Debit Claim Status

DTD XML Schema

Purpose: To submit the "final disposition" of a claim that had been pending in PIP5D5, Create Ship from Stock and Debit Claim. This final resolution must be provided within 336 hours of when the claim item was pending in PIP5D5 (using the Ship from Stock and Credit Response). If this time to perform is not met, this PIP and PIP5D5 time out and the claim must be resubmitted by the Product Distributor.

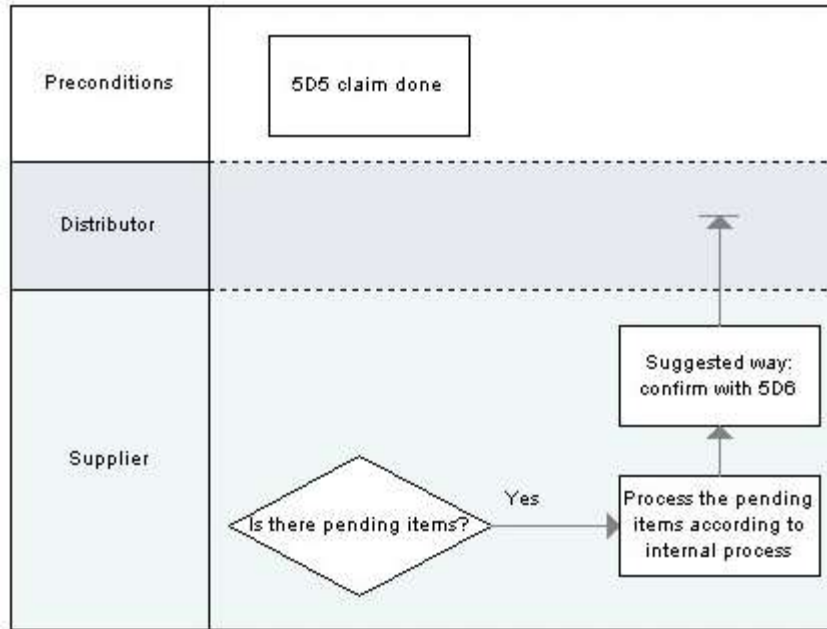

Note: RosettaNet Implementation Guides is available for PIP 5D6 version R01.00.00 (This is a released version which is similar to 5D5 but it was not validated)

8.2.7 PIP 5D7: Notify of Ship From Stock And Debit Authorization Request

DTD XML Schema

Purpose: This PIP enables a distributor to request authorization to sell stock at a new buy price and claim reimbursement for the difference between the original price and the new price.

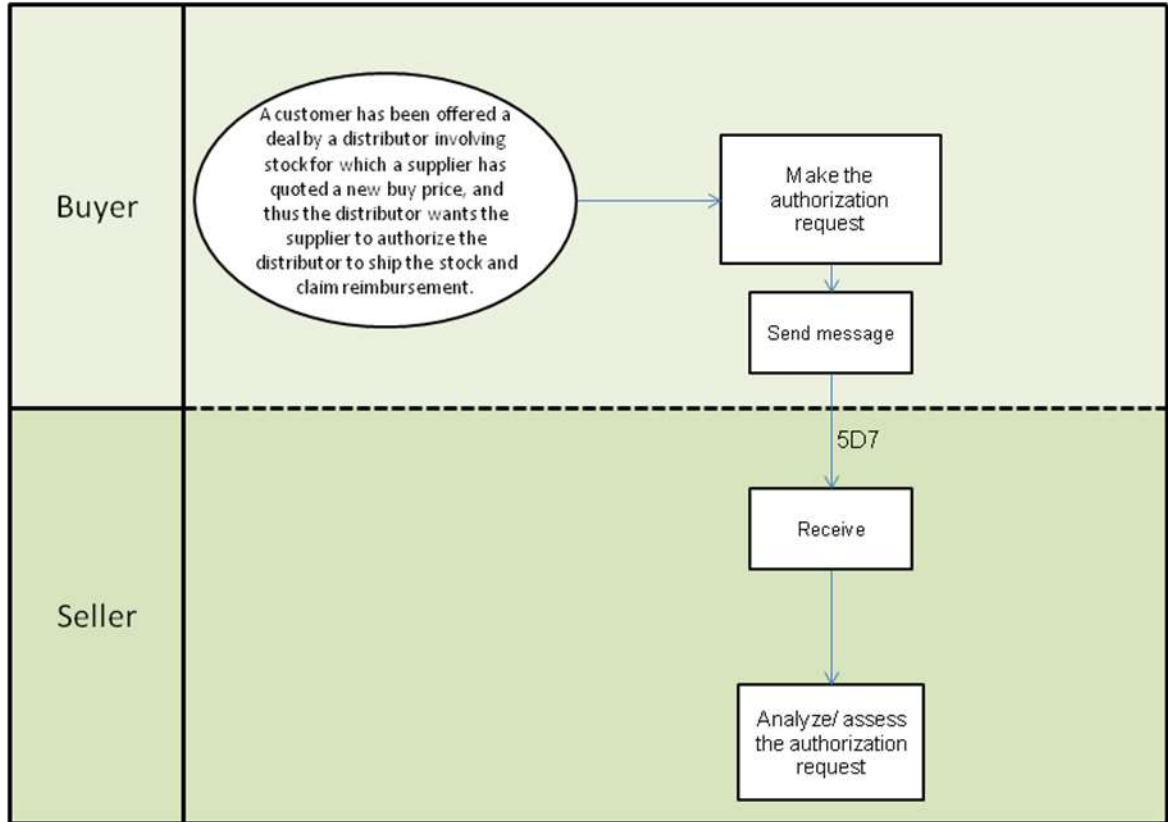

8.2.8 PIP 5D8: Notify of Ship From Stock And Debit Authorization Confirmation

DTD XML Schema

Purpose: This PIP is used by the Product Distributor to submit a claim for a debit against an authorization program, and to receive a claim response.

This PIP is executed when the product fulfillment status is known and the customer has been billed.

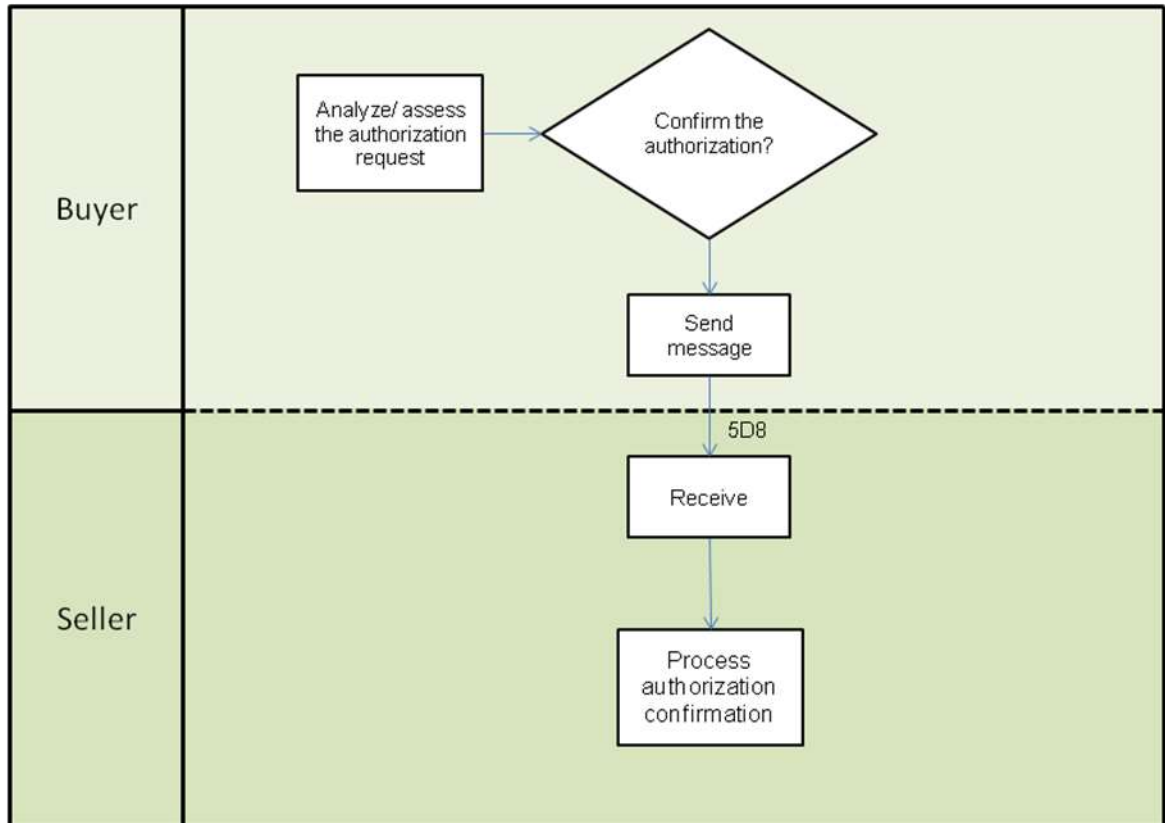

8.2.9 PIP 5D9: Notify of Ship From Stock And Debit Claim Request

DTD XML Schema

Purpose: This PIP is used to provide a claim response. The claim is either accepted, rejected or placed in "Pending" status. A disposition is generated for each line item. If accepted, the Product Supplier's financial system generates a credit to the Product Distributor. Rejected lines are reported with multiple reason codes, allowing the Product Distributor to close out the item or to fix the problem and resubmit the claim.

This PIP is executed when the product fulfillment status is known and the customer has been billed.

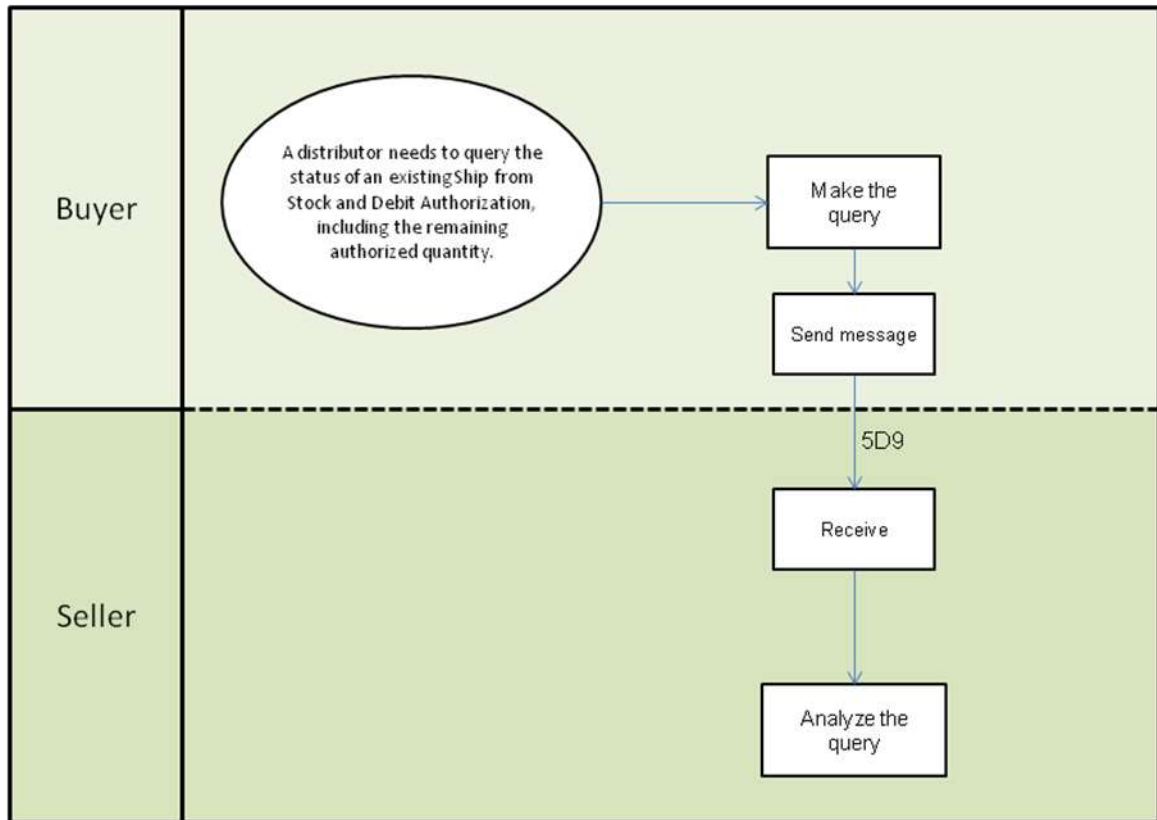

8.2.10 PIP 5D10: Notify of Ship From Stock And Debit Claim Confirmation

DTD XML Schema

Purpose: This PIP is used to provide a claim response. The claim is either accepted, rejected or placed in "Pending" status. A disposition is generated for each line item. If accepted, the Product Supplier's financial system generates a credit to the Product Distributor. Rejected lines are reported with multiple reason codes, allowing the Product Distributor to close out the item or to fix the problem and resubmit the claim.

This PIP is executed when the product fulfillment status is known and the customer has been billed.

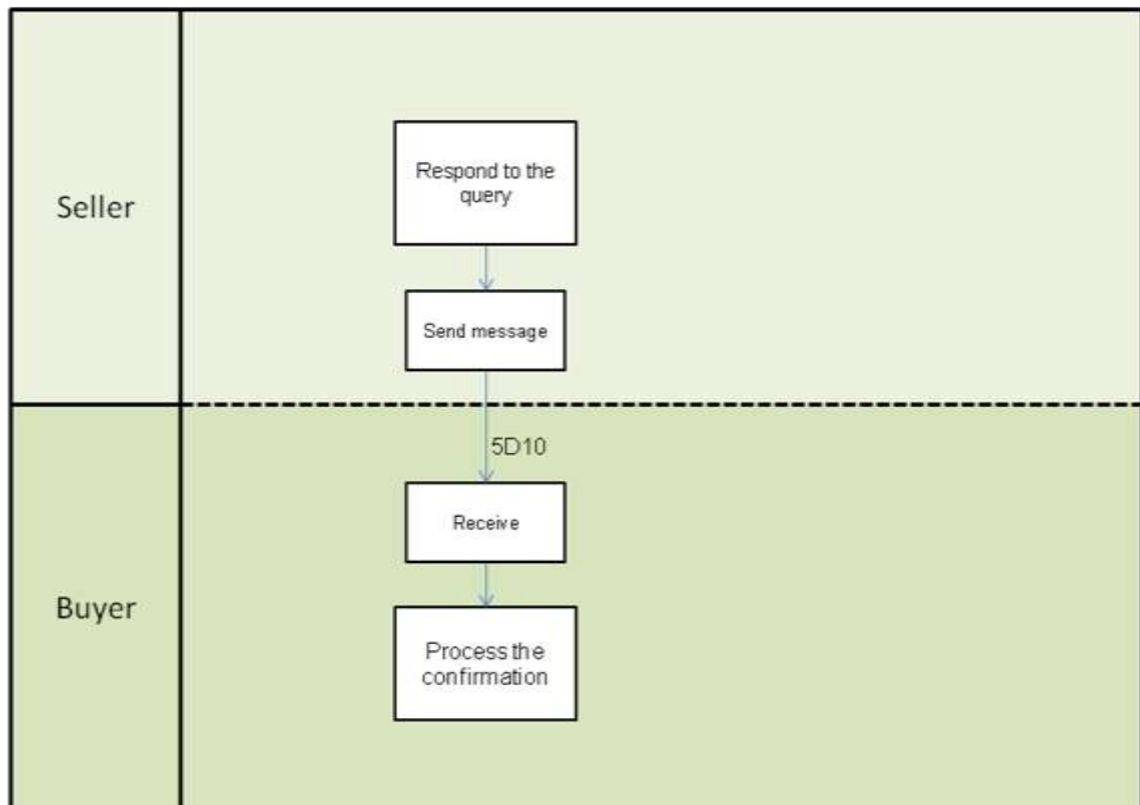

9 Cluster 6: Service and Support

This cluster provides post-sales technical support, service warranty and asset management capabilities.

9.1 Segments 6A: Provide and Administer Warranties, Service Packages, and Contract Services

This segment enables registration and product warranty support.

9.1.1 PIP 6A1 – Notify of Service Contract Request

DTD XML Schema

Purpose: Enable the change request or query of service contract information from a contract requester to its contract issuer.

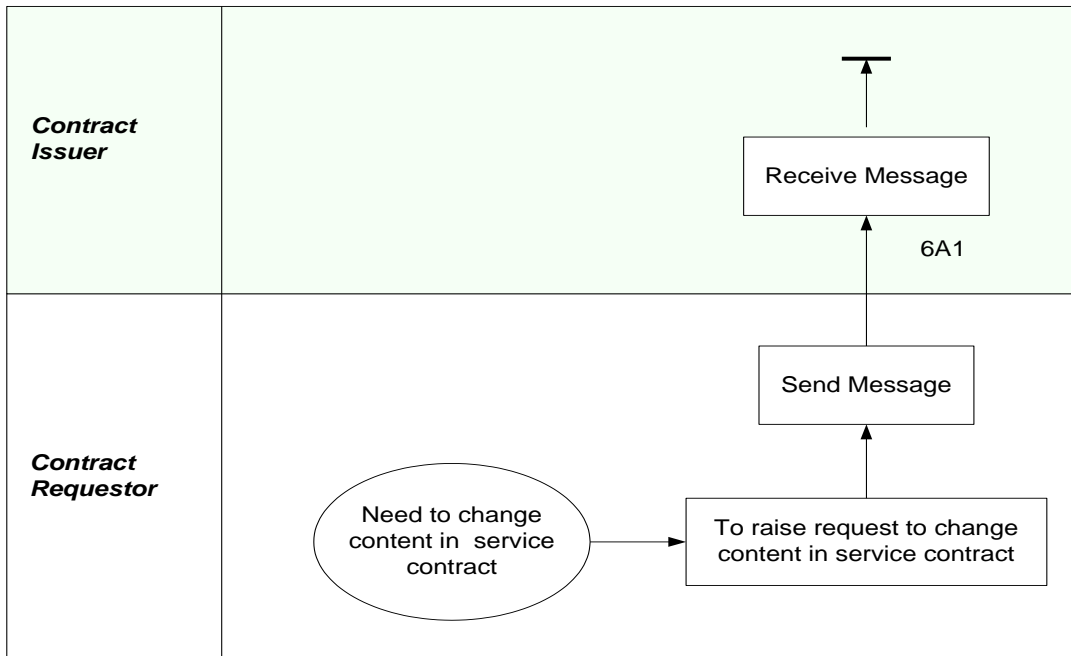

9.1.2 PIP 6A2 – Notify of Service Contract Reply

DTD XML Schema

Purpose: Enable the notification of service contract reply from service contract issuer to service contract requester.

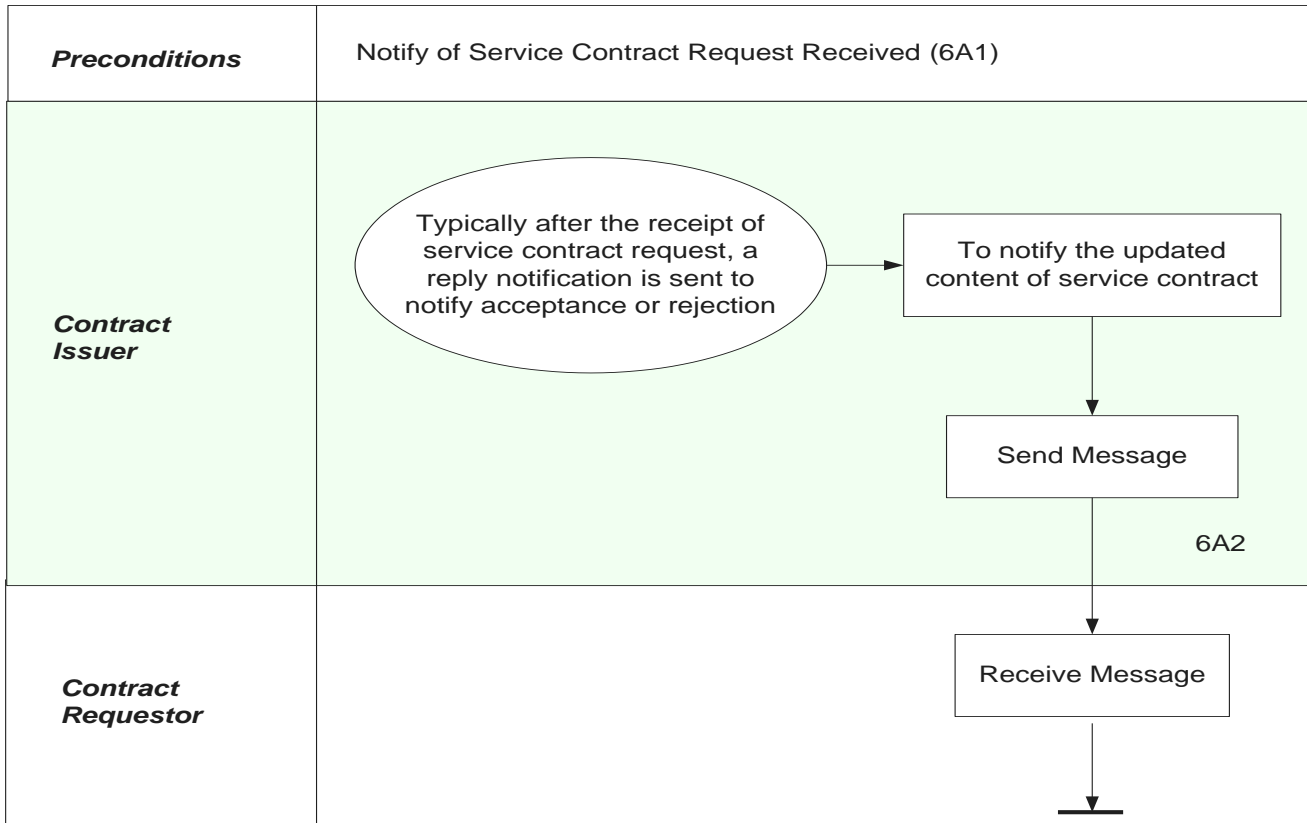

9.2 Segment 6C: Technical Support & Service Management

This segment automates the sharing of information within the technical support and service management.

9.2.1 PIP 6C1: Query Service Entitlement

- DTD
- XML Schema

Purpose: To automate the sharing of service entitlement information between the ASP and the WP. Service Event information for a unit must be requested from the WP. The request for service entitlement can be invoked independently for basic warranty entitlement verification for information only or (more commonly) as the initial step of a service event to verify the warranty coverage conditions that apply.

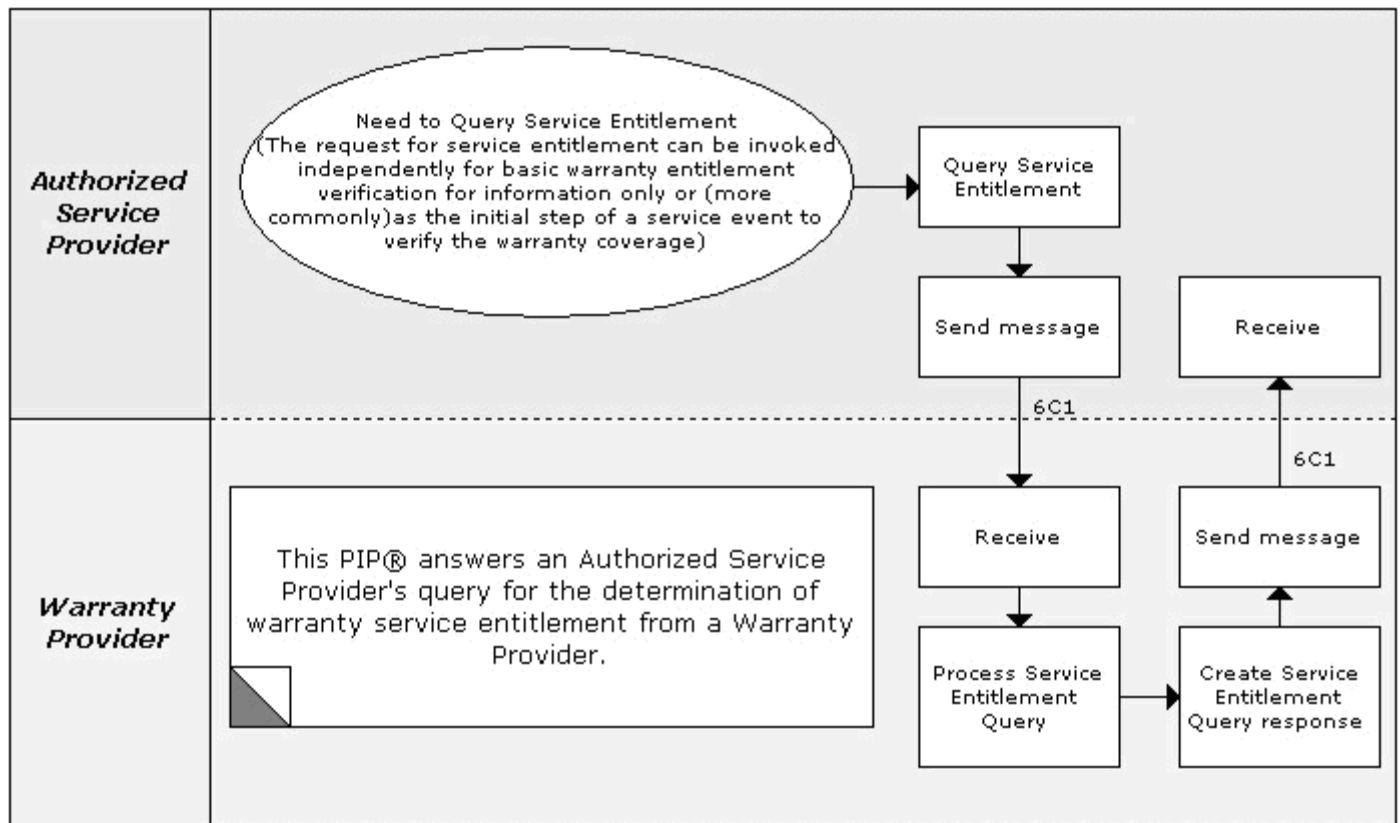

9.2.2 PIP 6C2: Request Warranty Claim

DTD XML Schema

Purpose: This enables an Authorized Service Provider to submit a Warranty Claim to a Warranty Provider for a service event performed on a unit under warranty and the Warranty Provider to respond to the request. The submitted claim can be either a Part and Labor Claim or a Labor Only claim.

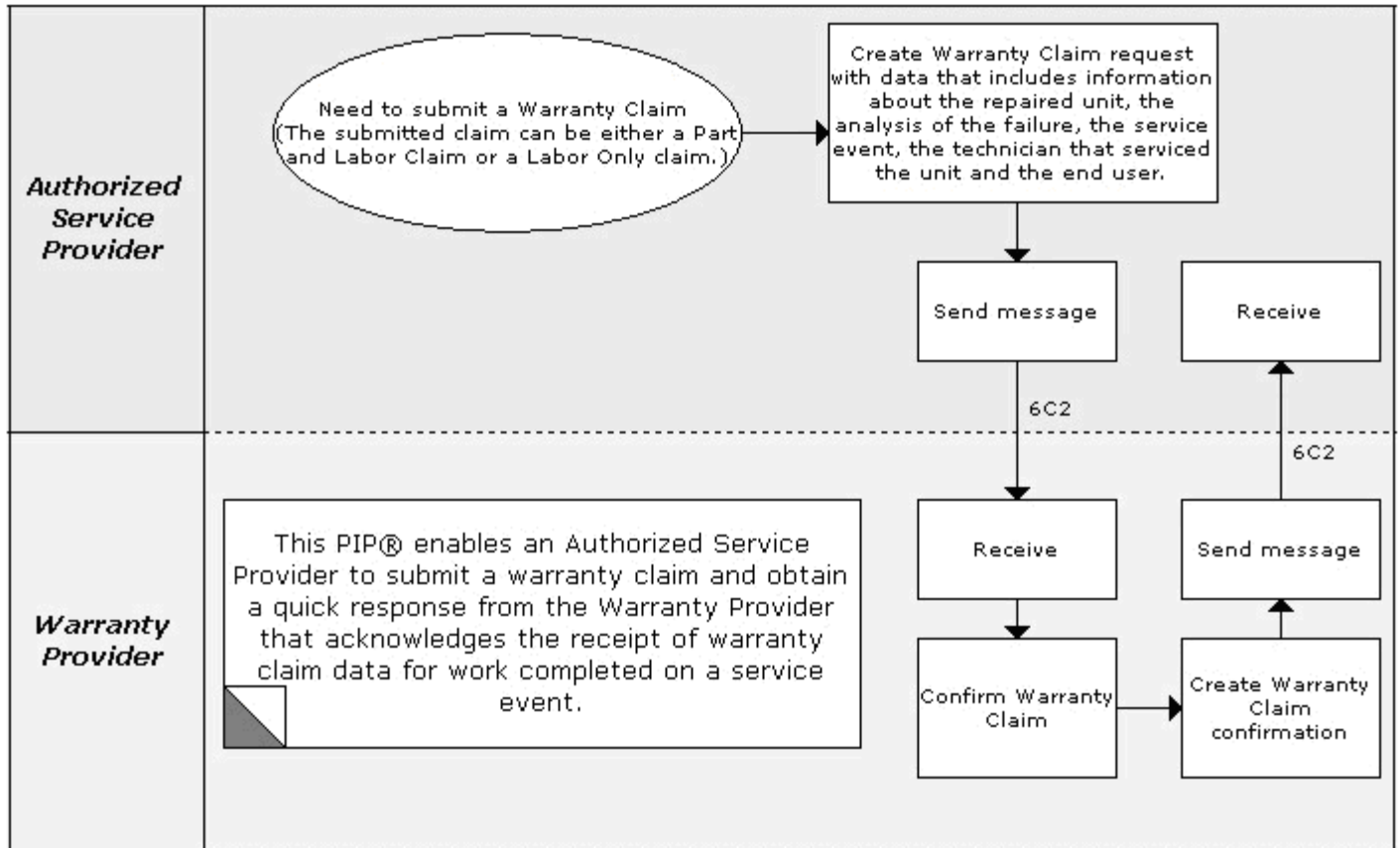

9.2.3 PIP 6C3: Notify of Case Request

DTD XML Schema

Purpose: To allow a case sender or case receiver to initiate a case or update the status of an existing case.

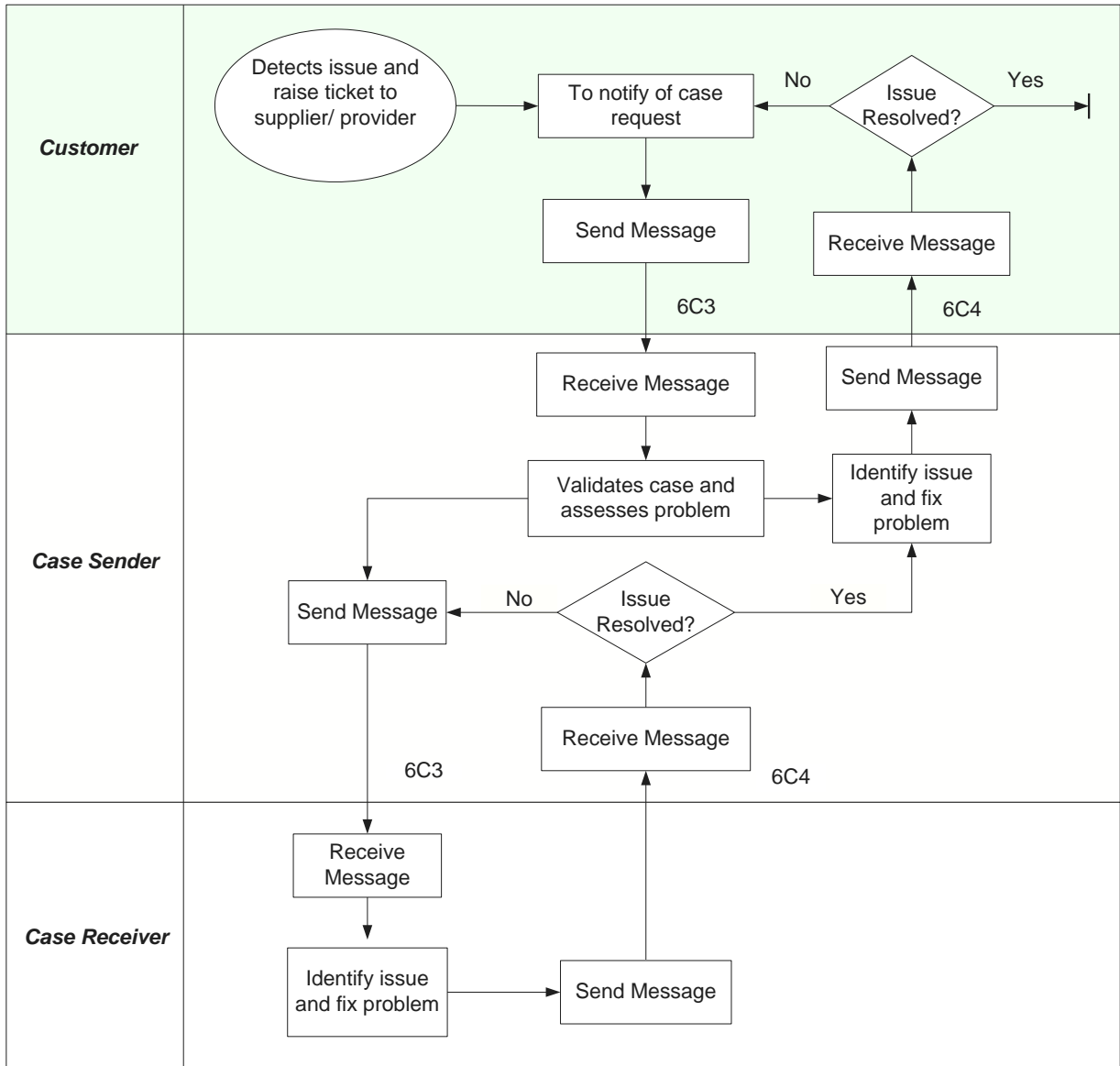

9.2.4 PIP 6C4: Notify of Case Confirmation

DTD XML Schema

Purpose: To allow the case sender or case receiver to confirm the new or revised information. This PIP can be used in conjunction with PIP 6C3.

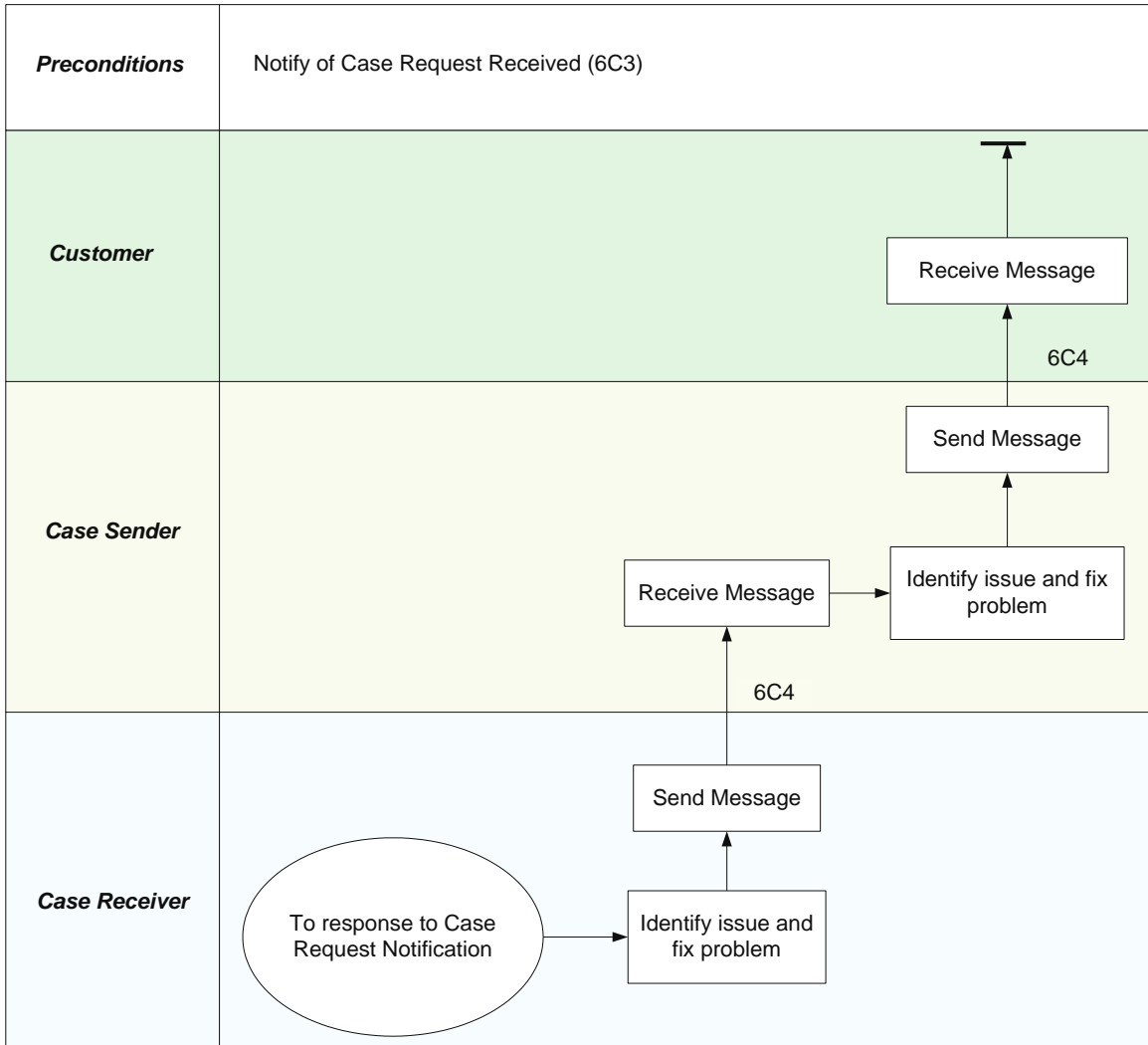

9.1.1 PIP 6C5: Distribute Service Entitlement Query

☒ DTD ☒ XML Schema

Purpose: This PIP allows an Authorized Service Provider's to query for the determination of warranty service entitlement from a Warranty Provider.

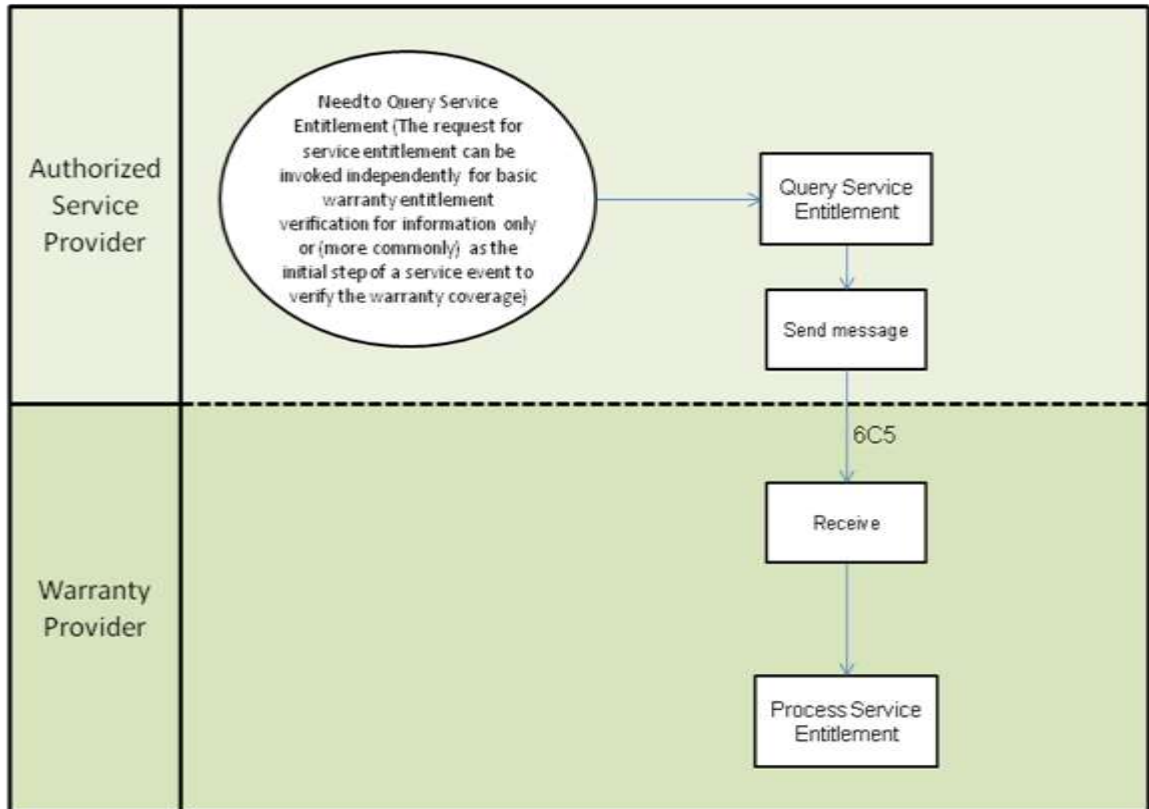

9.2.5 PIP 6C6: Distribute Service Entitlement Status Response

DTD XML Schema

Purpose: This PIP allows a Warranty Provider to respond to an Authorized Service Provider's query for the determination of warranty service entitlement.

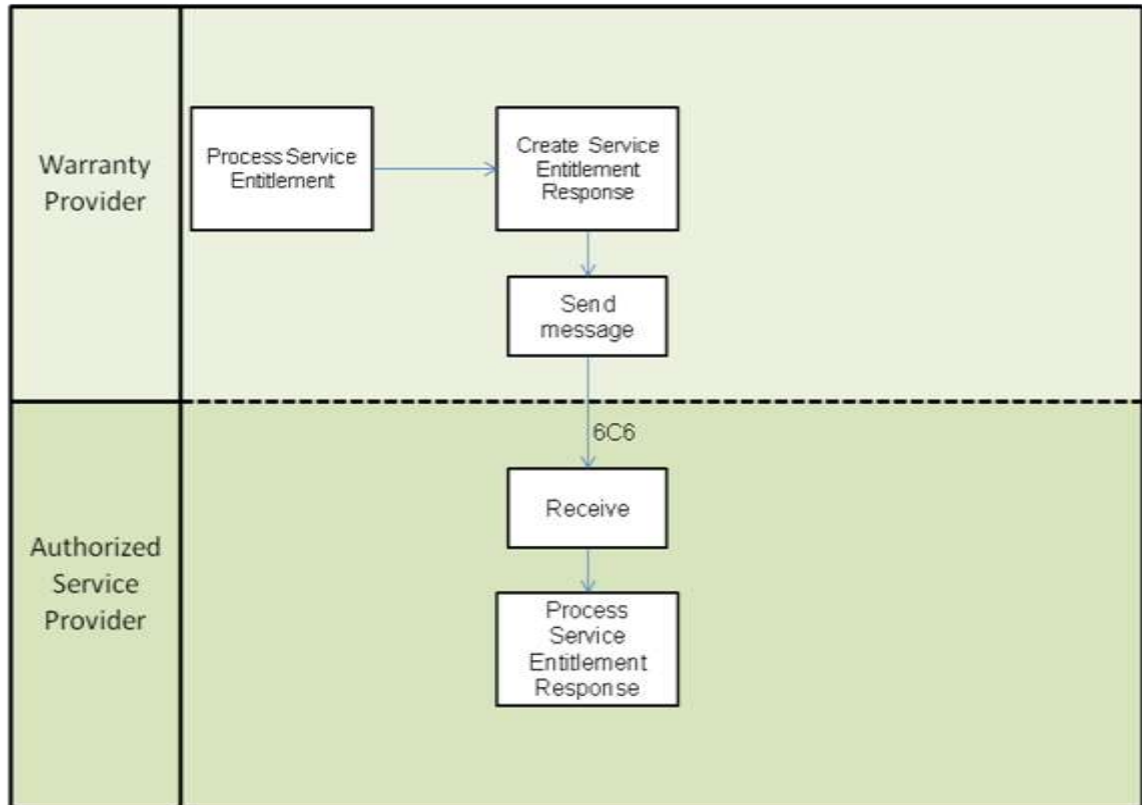

9.2.6 PIP 6C7: Notify of Warranty Claim Request

DTD XML Schema

Purpose: This PIP enables an Authorized Service Provider to submit a warranty claim to the Warranty Provider to check for the receipt of warranty claim data for work completed on a service event.

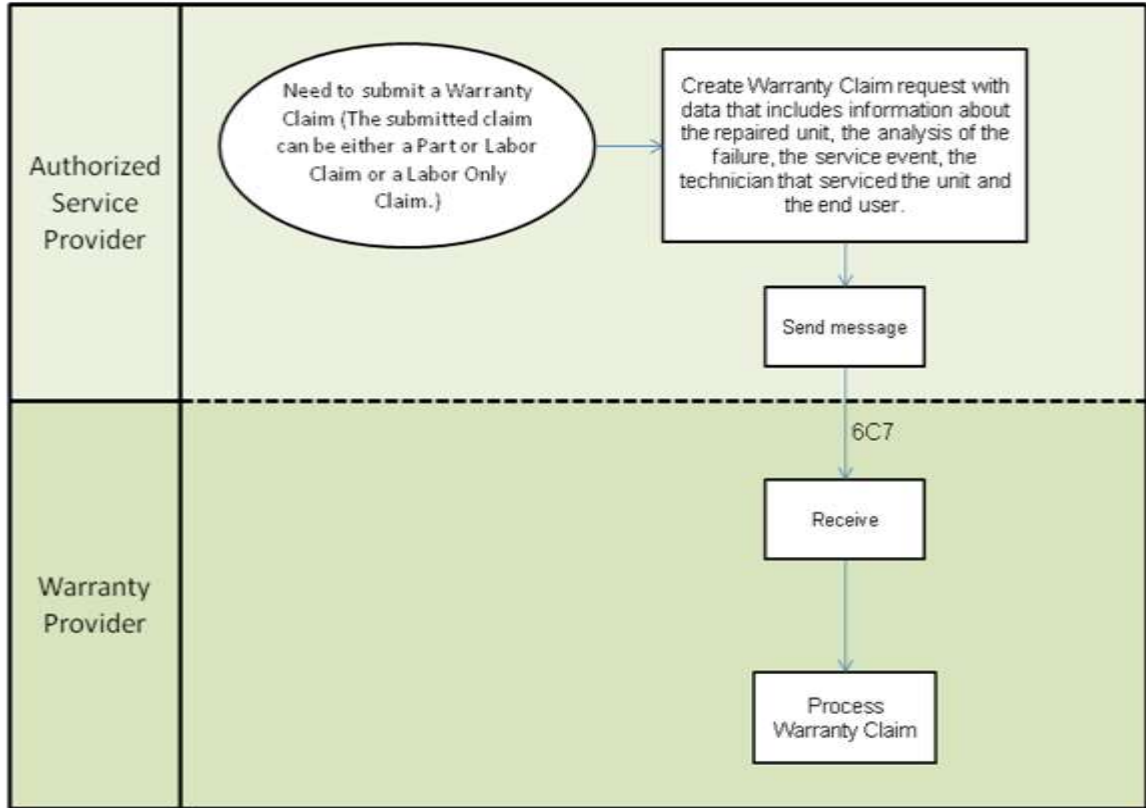

9.2.7 PIP 6C8: Notify of Warranty Claim Confirmation

DTD XML Schema

Purpose: This PIP enables the Warranty Provider to acknowledge the receipt of warranty claim data for work completed on a service event.

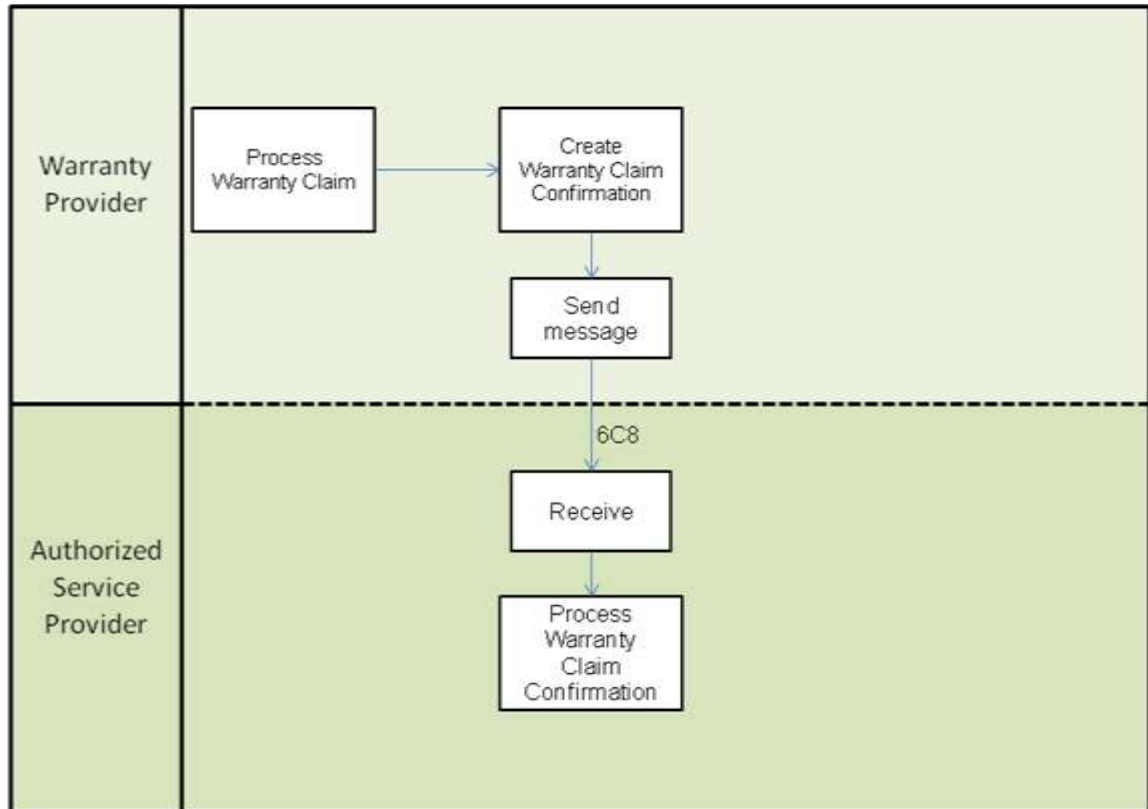

10 Cluster 7: Manufacturing

This cluster enables the exchange of design, configuration, process, quality and other manufacturing floor information to support the "Virtual Manufacturing" environment.

10.1 Segment 7B: Manage Manufacturing WO and WIP

This segment enables the release, management and the exchange of factory production information.

10.1.1 PIP 7B1: Distribute Work in Process

DTD XML Schema

Purpose: To support the process used by a product manufacturer or assembler to inform a party of product configuration status. The recipient of the product status information could either be an end customer or another party acting on behalf of the end customer.

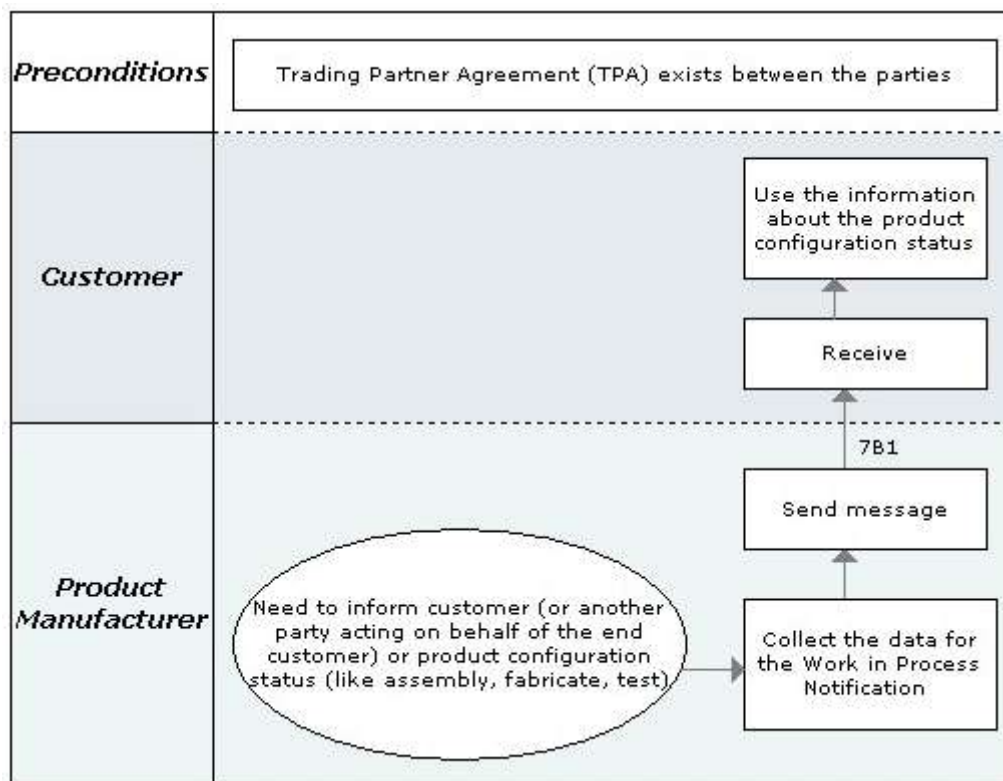

Note: RosettaNet Implementation Guides is available for PIP 7B1 version V01.00.00 (DTD).

10.1.2 PIP 7B2: Query Work in Process

DTD XML Schema

Purpose: To support the process used (1) by a solution requester (e. g. customer) to query the status of a product being assembled or manufactured, and (2) by a solution provider (e.g. manufacturer or assembler) to return the requested information. This process is usually executed when the product status is one of the following: Assembly, Test or Fabricate.

The solution requester initiates the process by sending a work in process query to the product solution provider. To facilitate communications, the query document includes both query constraint lines and incomplete results lines. After processing the query, the product solution provider completes the results lines and returns the information to the requesting party.

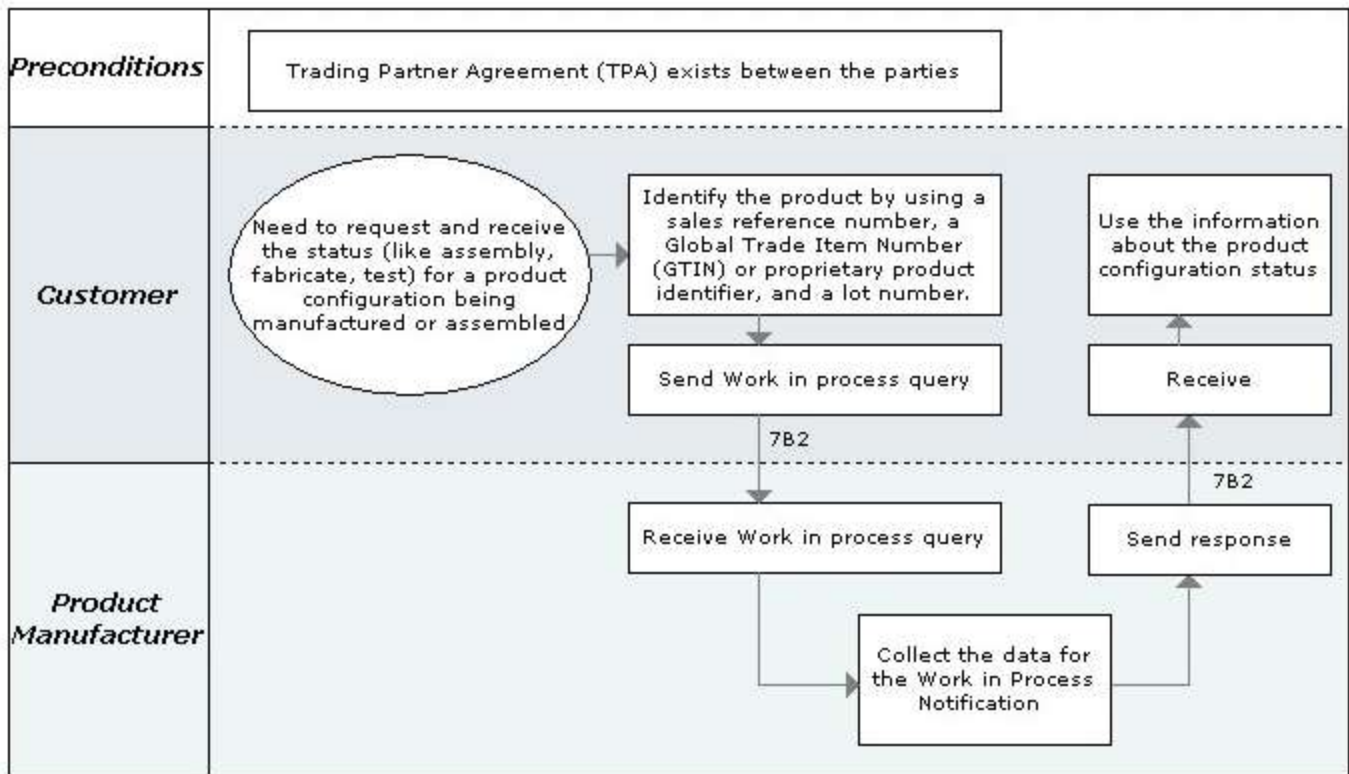

10.1.3 PIP 7B5: Notify Of Manufacturing Work Order

☒ DTD ☒ XML Schema

Purpose: To notify the seller of a work order to trigger production after a PO is issued or a contract agreement exists between trading partners. It focuses on the use of work order instructions to trigger a variety of manufacturing processes by contract manufacturers. Work orders are dependent on having a Purchase Order or by other contractual agreement, such as a Trading Partner Agreement, in place between trading partners before creating and transmitting a work order.

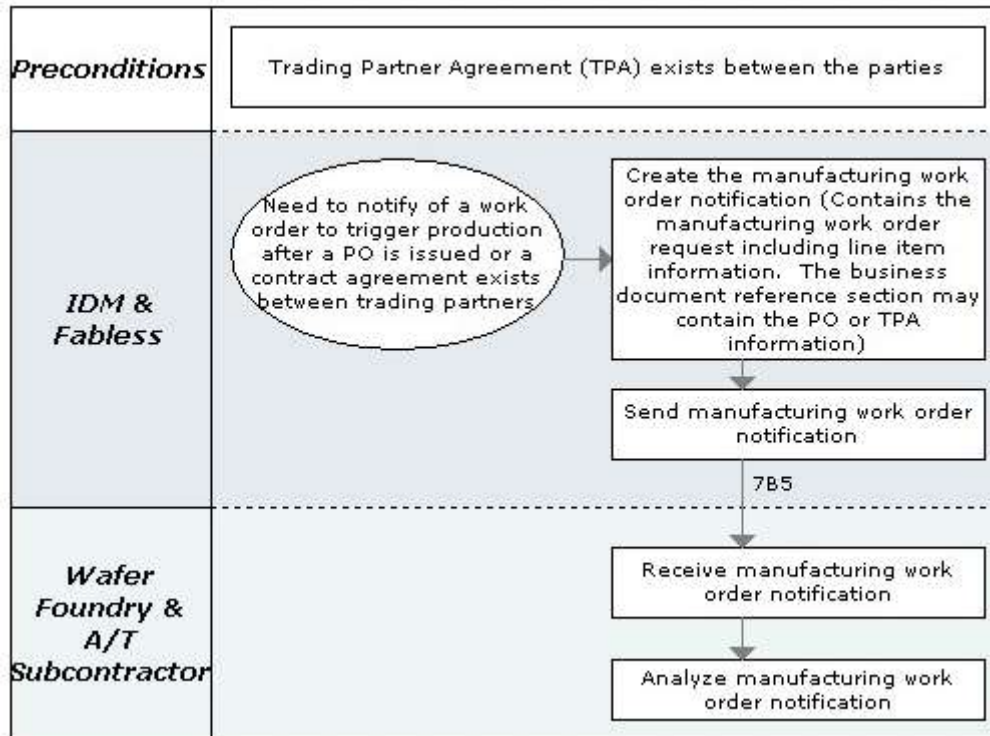

Note: RosettaNet Implementation Guides is available for PIP 7B5 version V01.00.00 (DTD) and version V01.01.00 (DTD).

10.1.4 PIP 7B6: Notify of Manufacturing Work Order Reply

DTD XML Schema

Purpose: To allow an optional response to a previous manufacturing work order request.

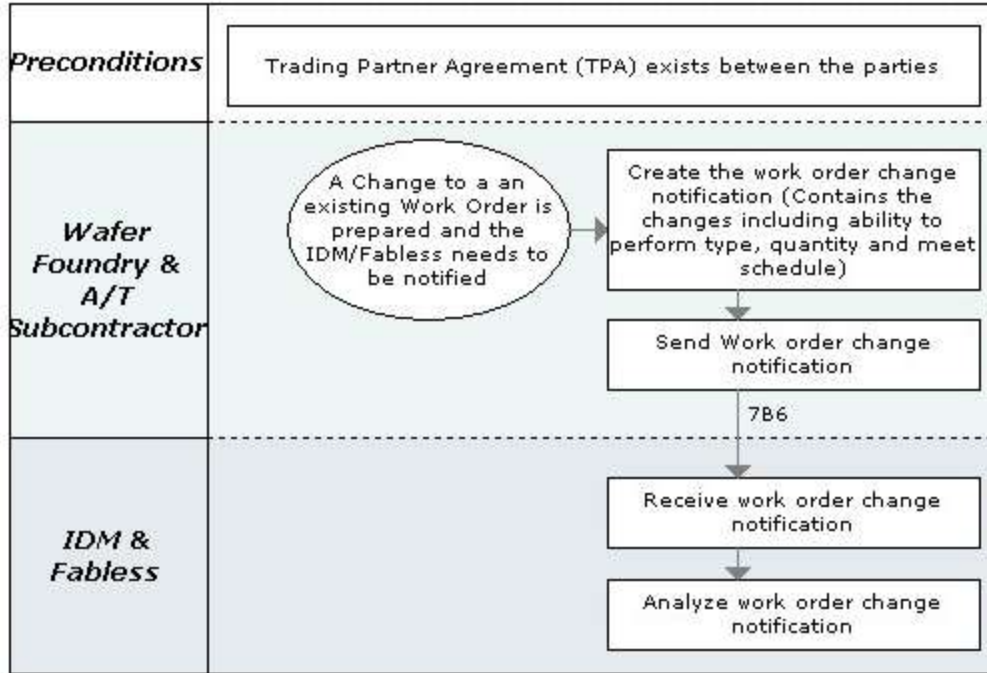

Note: RosettaNet Implementation Guides is available for PIP 7B6 version V01.00.00 (DTD).

10.2 Segment 7C: Distribute Manufacturing Information

Distribute manufacturing information to support product improvements, downstream manufacturing, Quality and warranty entitlement.

10.2.1 PIP 7C6: Distribute Product Quality Event Data

☒ DTD ☒ XML Schema

Purpose: This enables partners in a manufacturing/repair supply chain to share data related to the quality of services provided. There are two roles for this PIP®: Quality Data Provider (Provider) and Quality Data User (User). The same business entity may perform either role at different stages of the manufacturing/repair supply chain - i.e., a Provider of data for a high level product could become a User of data on a component it sends out for repair or analysis.

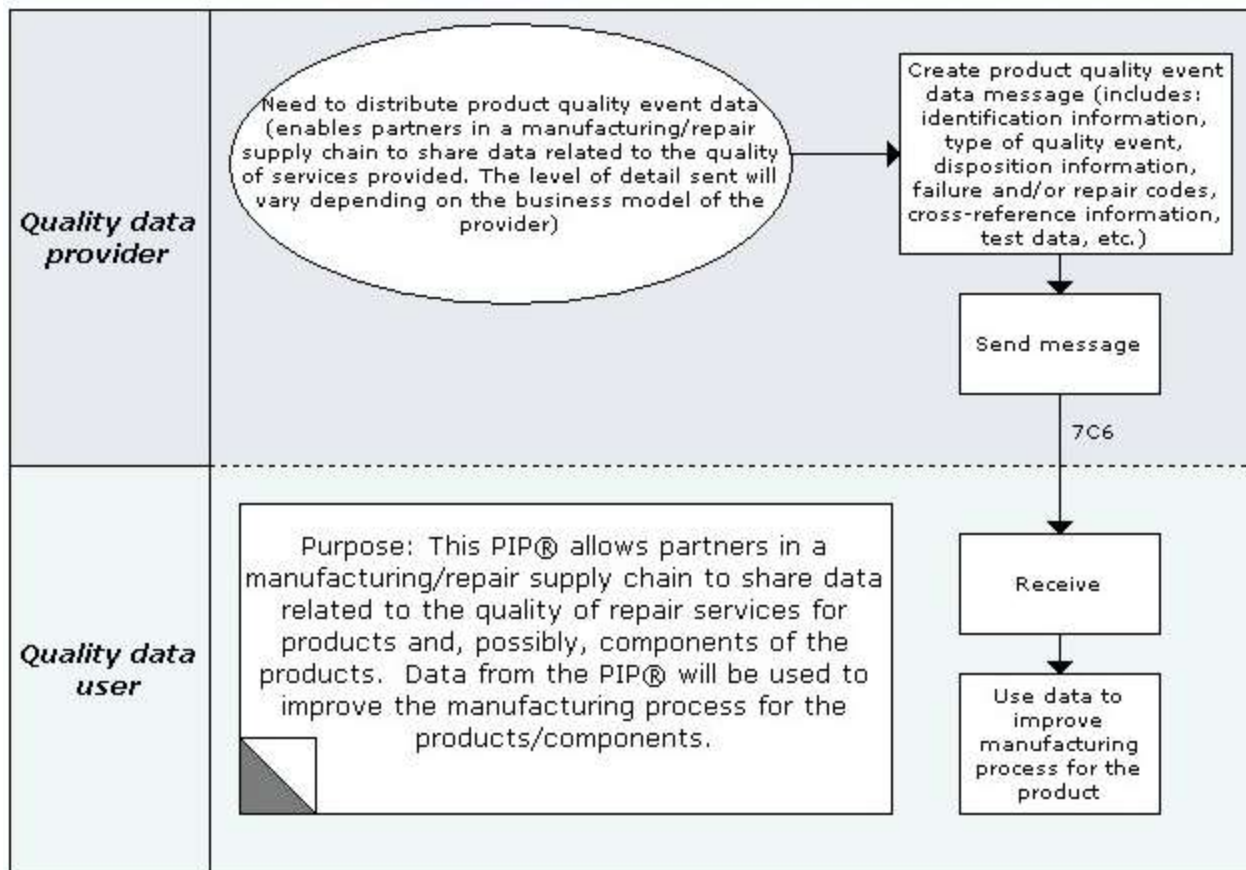

Note: RosettaNet Implementation Guides is available for PIP 7C6 version V01.00.00 (DTD).

10.2.2 PIP 7C7: Notify of Semiconductor Test Data

DTD XML Schema

Purpose: This enables foundry and assembly test partners to deliver summarized chip test data to Chip designers for data analysis. The test data includes inline test, wafer test (Sort) & module final test (Package Test).

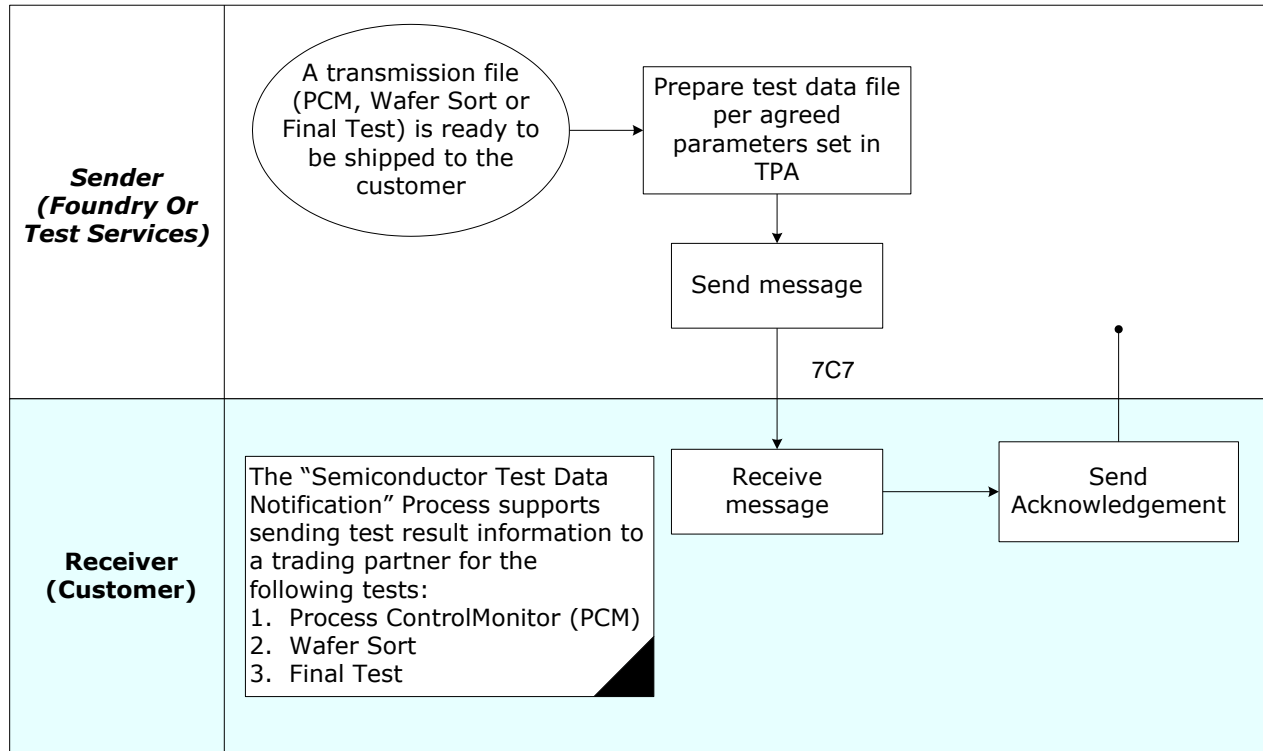

Note: RosettaNet Implementation Guides is available for PIP 7C7 version V11.00.00 (XML Schema) and version V11.11.00 (XML Schema).

10.2.3 PIP 7C8: Notify of Semiconductor Process Data

DTD XML Schema

Purpose: This enables foundry and other inline process partners to deliver semiconductor process and assembly process data to customers and to other data consumers including chip designers.

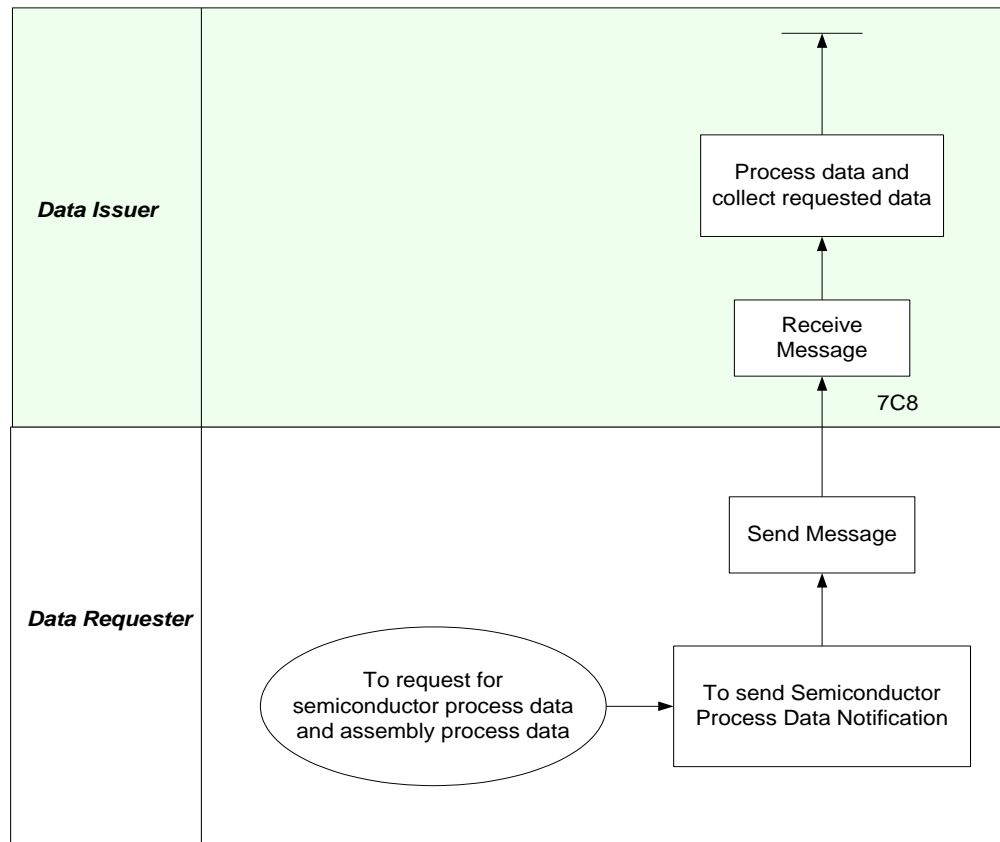

Note: RosettaNet Implementation Guides is available for PIP 7C8 version V11.00.00 (XML Schema) and version V11.10.00 (XML Schema).

10 Appendix: PIP Summary

Cluster/ Segment	PIP Name	DTD Version	XML Schema Version
0A	PIP 0A1: Notification of Failure	V02.00.00	NA
0C	PIP 0C1: Asynchronous Test Notification	R01.01.00 R01.02.00	NA
	PIP 0C2: Asynchronous Test Request / Confirmation	R01.01.00 R01.02.00 R01.02.01 R01.03.00	NA
	PIP 0C3: Synchronous Test Notification	R01.01.00 R01.02.00	NA
	PIP 0C4: Synchronous Test Query / Response	R01.01.00 R01.02.00 R01.02.01	NA
1A	PIP 1A1: Request Account Setup	B01.00.00A	NA
	PIP 1A2: Maintain Account	B01.00.00A B01.00.00B	NA
2A	PIP 2A1: Distribute Product Catalog Information	V02.00.00 (RIG Available) V02.01.00 V02.02.00 V02.03.00 V02.04.00	V11.00.00 V11.01.00
	PIP 2A3: Query Marketing Information	B01.00.00A	NA
	PIP 2A4: Query Sales Promotion & Rebate Information	B01.00.00A	NA
	PIP 2A6: Query Product Lifecycle Information	B01.00.00A	NA
	PIP 2A7: Query Product Discontinuation Information	B01.00.00A	NA
	PIP 2A9: Query Technical Product Information	V01.00.00 V01.01.00 V01.01.01	NA
	PIP 2A10: Distribute Design Engineering Information	V01.00.00 (RIG Available) V02.00.00 (RIG Available)	NA
	PIP 2A12: Distribute Product Master	V01.00.00 V01.01.00 V01.02.00 V01.03.00	V11.00.00
	PIP 2A13: Distribute Material Composition Information	NA	V11.00.00 (RIG Available) V11.01.00 V11.03.00
	PIP 2A15: Request Material Composition Information	NA	R11.00.00A
PIP 2A16: Distribute Engineering Information Inquiry	NA	V11.00.00 (RIG Available)	

Cluster/ Segment	PIP Name	DTD Version	XML Schema Version
	PIP 2A17: Notify of Certificate of Analysis	NA	V11.00.00 (RIG Available) V11.01.00
	PIP 2A18: Notify of Certificate of Analysis Response	NA	V11.00.00 (RIG Available)
2B	PIP 2B1: Change Basic Product Information	B01.00.00A B01.00.00B	NA
	PIP 2B2: Change Marketing Information	B01.00.00A	NA
	PIP 2B3: Change Sales Promotion & Rebate Information	B01.00.00A	NA
	PIP 2B4: Change Product Technical Information	B01.00.00A	NA
	PIP 2B5: Change Product Lifecycle Information	B01.00.00A	NA
	PIP 2B7: Notify of Product Change	NA	R11.00.00A
	PIP 2B8: Notify of Product Change Query	NA	R11.00.00A
	PIP 2B9: Notify of Product Change Acceptance	NA	R11.00.00A
2C	PIP 2C1: Distribute Engineering Change Status	R01.00.00A	NA
	PIP 2C2: Request Engineering Change	R01.00.00A	R11.00.00
	PIP 2C3: Distribute Engineering Change Response	R01.00.00A	NA
	PIP 2C4: Request Engineering Change Approval	R01.00.00A	NA
	PIP 2C5: Notify of Engineering Change Order	R01.00.00A	NA
	PIP 2C6: Notify of Engineering Change Implementation Plan	R01.00.00A	NA
	PIP 2C7: Request Bill Of Material	R01.00.00A	R11.00.00A
	PIP 2C8: Notify of Bill Of Material	R01.00.00A	R11.00.00A
	PIP 2C9: Request Approved Manufacturer List	R01.00.00	NA
	PIP 2C10: Notify of Approved Manufacturer List	R01.00.00A	R11.00.00A
3A	PIP 3A1: Request Quote	V02.00.00 (RIG Available) V02.01.00 V02.02.00 V02.03.00	V11.10.00 (RIG Available) V11.11.00 V11.12.00
	PIP 3A2: Request Price and Availability	V02.00.00 (RIG Available) V02.01.00	V11.00.00 V11.00.01 V11.01.00
	PIP 3A3: Request Shopping Cart Transfer	R02.00.00	NA
	PIP 3A4: Request Purchase Order	V02.00.00 V02.01.00 V02.02.00 V02.03.00 (RIG Available) V02.04.00 V02.05.00 V02.06.00	V11.10.00 (RIG Available) V11.11.00 V11.12.00 V11.13.00 V11.14.00 V11.15.00
	PIP 3A5: Query Order Status	R02.00.00	NA

Cluster/ Segment	PIP Name	DTD Version	XML Schema Version
	PIP 3A6: Distribute Order Status	V02.00.00 V02.02.00 V02.03.00 (RIG Available) V02.04.00	V11.00.00 V11.01.00
	PIP 3A7: Notify of Purchase Order Update	V02.00.00 V02.01.00 V02.02.00 V02.03.00 V02.04.00	R11.03.00D
	PIP 3A8: Request Purchase Order Change	V01.00.00 V01.01.00 V01.02.00 V01.03.00 V01.04.00	V11.00.00 V11.01.00 V11.02.00
	PIP 3A9: Request Purchase Order Cancellation	V01.00.00 V01.01.00 V01.02.00	V11.00.00 V11.01.00
	PIP 3A10: Notify of Quote Acknowledgment	R01.00.00	NA
	PIP 3A13: Notify of Purchase Order Information	V01.00.00 (RIG Available) V01.00.01	R11.10.00A
	PIP 3A14: Distribute Planned Order	R01.00.00A	NA
	PIP 3A15: Notify of Quote Request	V01.00.00	V11.00.00
	PIP 3A16: Notify of Quote Confirmation	V01.00.00	V11.00.00
	PIP 3A17: Distribute Price And Availability Request	V01.00.00	V11.00.00 V11.01.00
	PIP 3A18: Distribute Price And Availability Response	V01.00.00	V11.00.00 V11.01.00
	PIP 3A19: Notify of Purchase Order Request	V01.00.00	V11.00.00
	PIP 3A20: Notify of Purchase Order Confirmation	V01.00.00	V11.00.00
	PIP 3A21: Notify of Purchase Order Change Request	V01.00.00	V11.00.00
	PIP 3A22: Notify of Purchase Order Change Confirmation	V01.00.00	V11.00.00
	PIP 3A23: Notify of Purchase Order Cancellation Request	V01.00.00	V11.00.00
	PIP 3A24: Notify of Purchase Order Cancellation Confirmation	V01.00.00	V11.00.00
3B	PIP 3B1: Distribute Transportation Projection	R01.00.00A	NA
	PIP 3B2: Notify of Advance Shipment	V01.00.00 V01.01.00 V01.02.00 (RIG Available) V01.03.00	V11.00.00 V11.01.00 V11.02.00 V11.03.00
	PIP 3B3: Distribute Shipment Status	R01.00.00A	V11.00.00 V11.11.00 V11.12.00

Cluster/ Segment	PIP Name	DTD Version	XML Schema Version
	PIP 3B4: Query Shipment Status	R01.00.00A	NA
	PIP 3B5: Request Shipment Change	R01.00.00A	NA
	PIP 3B6: Notify of Shipments Tendered	R01.00.00A	NA
	PIP 3B11: Notify Of Shipping Order	V01.00.00	NA
	PIP 3B12: Request Shipping Order	V01.01.00 (RIG Available) V01.02.00 V01.03.00	V11.01.00 (RIG Available) V11.02.00 V11.03.00 V11.04.00
	PIP 3B13: Notify of Shipping Order Confirmation	V01.01.00 (RIG Available) V01.03.00 V01.04.00	V11.00.00
	PIP 3B14: Request Shipping Order Cancellation	V01.00.00 (RIG Available) V01.01.00 V01.02.00	V11.00.01 V11.01.00 V11.02.00
	PIP 3B18: Notify of Shipment Documentation	V01.00.00 (RIG Available) V01.01.00 V01.02.00	V11.00.00 (RIG Available) V11.01.00 V11.10.00 V11.11.00 V11.12.00
	PIP 3B19: Notify of Shipping Order Request	V01.00.00 V01.01.00	V11.00.00
	PIP 3B20: Notify of Shipping Order Confirmation	V01.00.00 V01.01.00	V11.00.00
	PIP 3B21: Notify of Shipping Order Cancellation Request	V01.00.00	V11.00.00
	PIP 3B22: Notify of Shipping Order Cancellation Confirmation	V01.00.00	V11.00.00
3C	PIP 3C1: Return Product	V01.00.00 V01.01.00 V01.02.00	V11.00.00 V11.01.00
	PIP 3C2: Request Financing Approval	R01.00.00	NA
	PIP 3C3: Notify of Invoice	V01.00.00 V01.01.00 V01.02.00 V01.03.00 (RIG Available)	V11.01.00 V11.02.00 V11.03.00 V11.04.00
	PIP 3C4: Notify of Invoice Reject	V01.00.00 V01.01.00	V11.02.00 V11.03.00 V11.04.00 V11.05.00
	PIP 3C5: Notify of Billing Statement	R01.00.00	NA

Cluster/ Segment	PIP Name	DTD Version	XML Schema Version
	PIP 3C6: Notify of Remittance Advice	V01.00.00 V01.01.00 V01.02.00 V01.03.00 (RIG Available)	V11.00.00 V11.01.00 V11.02.00 V11.03.00
	PIP 3C7: Notify of Self-Billing Invoice	V01.00.00 (RIG Available) V01.00.01 V01.01.00	V11.01.00 V11.02.00 V11.03.00 V11.04.00
	PIP 3C8: Notify of Return Product Request	V01.00.00	V11.00.00
	PIP 3C9: Notify of Return Product Confirmation	V01.00.00	V11.00.00
4A	PIP 4A1: Notify of Strategic Forecast	V02.00.00	V11.00.00
	PIP 4A2: Notify of Embedded Release Forecast	R01.00.00A R02.00.00A V02.00.00 (RIG Available)	R11.00.00A V11.00.00
	PIP 4A3: Notify of Threshold Release Forecast	V01.00.00 (RIG Available) V02.00.00 V02.01.00 (RIG Available) V02.02.00 (RIG Available) V02.03.00	V11.00.00
	PIP 4A4: Notify of Planning Release Forecast	V01.00.00 V03.00.00 (RIG Available)	V11.00.00
	PIP 4A5: Notify of Forecast Reply	V01.00.00 (RIG Available) V02.00.00	V11.00.00
	PIP 4A6: Notify of Forecasting Exception	R01.00.00A	NA
4B	PIP 4B2: Notify of Shipment Receipt	V01.00.00 (RIG Available) V01.01.00	V11.00.00 V11.00.01 V11.01.00
	PIP 4B3: Notify of Consumption	V01.00.00 (RIG Available) V01.01.00 V01.02.00 V01.03.00	V11.00.00 V11.00.01
4C	PIP 4C1: Distribute Inventory Report	V02.00.00 V02.01.00 V02.02.00 V02.03.00 V02.06.00 V02.07.00 V02.08.00	V11.00.00 V11.01.00 V11.02.00
4D	PIP 4D1: Notify of Material Release	V01.00.01 (RIG Available)	V11.00.00

Cluster/ Segment	PIP Name	DTD Version	XML Schema Version
4E	PIP 4E1: Notify of Sales Report	NA	V11.00.00 (RIG Available) V11.11.00
	PIP 4E2: Notify of Sales Report Acknowledgement	NA	R11.00.00A
5C	PIP 5C1: Distribute Product List	V01.00.00	V11.00.00
	PIP 5C2: Request Design Registration	V01.00.00 V01.01.00 (RIG Available) V01.02.00 V01.03.00	V11.00.00 V11.01.00
	PIP 5C3: Create Design Win	V01.00.00 V01.01.00 (RIG Available) V01.02.00	V11.00.00 V11.01.00
	PIP 5C4: Distribute Registration Status	V01.01.00 V01.02.00 V01.03.00 V01.04.00 V01.05.00 (RIG Available) V01.06.00	V11.00.00
	PIP 5C5: Query Registration Status	B01.00.00A	NA
	PIP 5C6: Notify of Design Registration Request	V01.00.00	V11.00.00
	PIP 5C7: Notify of Design Registration Confirmation	V01.00.00	V11.00.00
	PIP 5C8: Notify of Win Claim Request	V01.00.00	V11.00.00
	PIP 5C9: Notify of Win Claim Confirmation	V01.00.00	V11.00.00
	5D	PIP 5D1: Request Ship from Stock and Debit Authorization	V01.00.00 (RIG Available) V01.01.00 V01.02.00
PIP 5D2: Notify of Blanket Ship from Stock and Debit Authorization		R01.00.00	NA
PIP 5D3: Distribute Open Ship from Stock and Debit Authorization Status		V01.00.00 (RIG Available) V01.01.00 V01.02.00	V11.00.00 V11.01.00
PIP 5D4: Query Ship from Stock and Debit Authorization Status		R01.00.00A	NA
PIP 5D5: Create Ship from Stock and Debit Claim Status		V01.00.00 (RIG Available) V01.01.00	V11.00.00 V11.01.00
PIP 5D6: Notify of Ship from Stock and Debit Claim Status		R01.00.00A (RIG Available)	NA
PIP 5D7: Notify of Ship From Stock And Debit Authorization Request		V01.00.00	V11.00.00
PIP 5D8: Notify of Ship From Stock And Debit Authorization Confirmation		V01.00.00	V11.00.00
PIP 5D9: Notify of Ship From Stock And Debit Claim Request		V01.00.00	V11.00.00

Cluster/ Segment	PIP Name	DTD Version	XML Schema Version
	PIP 5D10: Notify of Ship From Stock And Debit Claim Confirmation	V01.00.00	V11.00.00
6A	PIP 6A1: Notify of Service Contract Request	NA	V11.10.00 (RIG Available)
	PIP 6A2: Notify of Service Contract Reply	NA	V11.10.00 (RIG Available)
6C	PIP 6C1: Query Service Entitlement	V01.00.00 V01.01.00	V11.00.00 V11.01.00
	PIP 6C2: Request Warranty Claim	V01.00.00 V01.01.00	V11.00.00 V11.01.00
	PIP 6C3: Notify of Case Request	NA	V11.00.00 (RIG Available) V11.00.01
	PIP 6C4: Notify of Case Confirmation	NA	V11.00.00 (RIG Available) V11.00.01
	PIP 6C5: Distribute Service Entitlement Query	V01.00.00	V11.00.00
	PIP 6C6: Distribute Service Entitlement Status Response	V01.00.00	V11.00.00
	PIP 6C7: Notify of Warranty Claim Request	V01.00.00	V11.00.00
	PIP 6C8: Notify of Warranty Claim Confirmation	V01.00.00	V11.00.00
7B	PIP 7B1: Distribute Work in Process	V01.00.00 (RIG Available) V01.01.00 V01.02.00	V11.00.00
	PIP 7B2: Query Work in Process	R01.00.00A	NA
	PIP 7B5: Notify Of Manufacturing Work Order	V01.00.00 (RIG Available) V01.01.00 (RIG Available) V01.02.00	V11.00.00 V11.01.00
	PIP 7B6: Notify of Manufacturing Work Order Reply	V01.00.00 (RIG Available)	R11.00.00A V11.00.00 V11.01.00
7C	PIP 7C6: Distribute Product Quality Event Data	V01.00.00 (RIG Available) V01.01.00	V11.00.00
	PIP 7C7: Notify of Semiconductor Test Data	NA	V11.00.00 (RIG Available) V11.10.00 V11.11.00 (RIG Available)
	PIP 7C8: Notify of Semiconductor Process Data	NA	V11.00.00 (RIG Available) V11.10.00 (RIG Available)